



FLEX I/O 8 Relay Output Module

Cat. No. Cat. No. 1794-OW8

Important User Information

Because of the variety of uses for the products described in this publication, those responsible for the application and use of these products must satisfy themselves that all necessary steps have been taken to assure that each application and use meets all performance and safety requirements, including any applicable laws, regulations, codes and standards. In no event will Rockwell Automation be responsible or liable for indirect or consequential damage resulting from the use or application of these products.

Any illustrations, charts, sample programs, and layout examples shown in this publication are intended solely for purposes of example. Since there are many variables and requirements associated with any particular installation, Rockwell Automation does not assume responsibility or liability (to include intellectual property liability) for actual use based upon the examples shown in this publication.

Allen-Bradley publication SGI-1.1, *Safety Guidelines for the Application, Installation and Maintenance of Solid-State Control* (available from your local Rockwell Automation office), describes some important differences between solid-state equipment and electromechanical devices that should be taken into consideration when applying products such as those described in this publication.

Reproduction of the contents of this copyrighted publication, in whole or part, without written permission of Rockwell Automation, is prohibited.

Throughout this publication, notes may be used to make you aware of safety considerations. The following annotations and their accompanying statements help you to identify a potential hazard, avoid a potential hazard, and recognize the consequences of a potential hazard:

WARNING Identifies information about practices or circumstances that can cause an explosion in a hazardous environment, which may lead to personal injury or death, property damage, or economic loss.

ATTENTION Identifies information about practices or circumstances that can lead to personal injury or death, property damage, or economic loss.

IMPORTANT Identifies information that is critical for successful application and understanding of the product.

ATTENTION **Environment and Enclosure**
This equipment is intended for use in a Pollution Degree 2 industrial environment, in overvoltage Category II applications (as defined in IEC publication 60664-1), at altitudes up to 2000 meters without derating.
This equipment is considered Group 1, Class A industrial equipment according to IEC/CISPR Publication 11. Without appropriate precautions, there may be potential difficulties ensuring electromagnetic compatibility in other environments due to conducted as well as radiated disturbance.
This equipment is supplied as "open type" equipment. It must be mounted within an enclosure that is suitably designed for those specific environmental conditions that will be present and appropriately designed to prevent personal injury resulting from accessibility to live parts. The interior of the enclosure must be accessible only by the use of a tool. Subsequent sections of this publication may contain additional information regarding specific enclosure type ratings that are required to comply with certain product safety certifications.
See NEMA Standards publication 250 and IEC publication 60529, as applicable, for explanations of the degrees of protection provided by different types of enclosure. Also, see the appropriate sections in this publication, as well as the Allen-Bradley publication 1770-4.1 ("Industrial Automation Wiring and Grounding Guidelines"), for additional installation requirements pertaining to this equipment.

WARNING When you insert or remove the module while backplane power is on, an electrical arc can occur. This could cause an explosion in hazardous location installations. Be sure that power is removed or the area is nonhazardous before proceeding.

ATTENTION FLEX I/O is grounded through the DIN rail to chassis ground. Use zinc plated yellow-chromate steel DIN rail to assure proper grounding. The use of other DIN rail materials (e.g. aluminum, plastic, etc.) that can corrode, oxidize, or are poor conductors, can result in improper or intermittent grounding.

ATTENTION **Preventing Electrostatic Discharge**
This equipment is sensitive to electrostatic discharge, which can cause internal damage and affect normal operation. Follow these guidelines when you handle this equipment:

- Touch a grounded object to discharge potential static.
- Wear an approved grounding wriststrap.
- Do not touch connectors or pins on component boards.
- Do not touch circuit components inside the equipment.
- If available, use a static-safe workstation.

European Hazardous Location Approval

The following module is European Zone 2 approved: 1794-OW8.



European Zone 2 Certification
This equipment is intended for use in potentially explosive atmospheres as defined by European Union Directive 94/9/EC.
The LCIE (Laboratoire Central des Industries Electriques) certifies that this equipment has been found to comply with the Essential Health and Safety Requirements relating to the design and construction of Category 3 equipment intended for use in potentially explosive atmospheres, given in Annex II to this Directive. The examination and test results are recorded in confidential report No. 28 682 010.
Compliance with the Essential Health and Safety Requirements has been assured by compliance with EN 50021.

IMPORTANT Observe the following additional Zone 2 certification requirements.

- This equipment is not resistant to sunlight or other sources of UV radiation.
- The secondary of a current transformer shall not be open-circuited when applied in Class I, Zone 2 environments.
- Equipment of lesser Enclosure Type Rating must be installed in an enclosure providing at least IP54 protection when applied in Class I, Zone 2 environments.
- This equipment shall be used within its specified ratings defined by Allen-Bradley.
- Provision shall be made to prevent the rated voltage from being exceeded by transient disturbances of more than 40% when applied in Class I, Zone 2 environments

North American Hazardous Location Approval

The following module is Hazardous Location approved: 1794-OW8.

The following information applies when operating this equipment in hazardous locations:		Informations sur l'utilisation de cet équipement en environnements dangereux :	
<p>Products marked "CL I, DIV 2, GP A, B, C, D" are suitable for use in Class I Division 2 Groups A, B, C, D, Hazardous Locations and nonhazardous locations only. Each product is supplied with markings on the rating nameplate indicating the hazardous location temperature code. When combining products within a system, the most adverse temperature code (lowest "T" number) may be used to help determine the overall temperature code of the system. Combinations of equipment in your system are subject to investigation by the local Authority Having Jurisdiction at the time of installation.</p>		<p>Les produits marqués "CL I, DIV 2, GP A, B, C, D" ne conviennent qu'à une utilisation en environnements de Classe I Division 2 Groupes A, B, C, D dangereux et non dangereux. Chaque produit est livré avec des marquages sur sa plaque d'identification qui indiquent le code de température pour les environnements dangereux. Lorsque plusieurs produits sont combinés dans un système, le code de température le plus défavorable (code de température le plus faible) peut être utilisé pour déterminer le code de température global du système. Les combinaisons d'équipements dans le système sont sujettes à inspection par les autorités locales qualifiées au moment de l'installation.</p>	
<p>WARNING</p> 	<p>EXPLOSION HAZARD</p> <ul style="list-style-type: none"> Do not disconnect equipment unless power has been removed or the area is known to be nonhazardous. Do not disconnect connections to this equipment unless power has been removed or the area is known to be nonhazardous. Secure any external connections that mate to this equipment by using screws, sliding latches, threaded connectors, or other means provided with this product. Substitution of components may impair suitability for Class I, Division 2. If this product contains batteries, they must only be changed in an area known to be nonhazardous. 	<p>AVERTISSEMENT</p> 	<p>RISQUE D'EXPLOSION</p> <ul style="list-style-type: none"> Couper le courant ou s'assurer que l'environnement est classé non dangereux avant de débrancher l'équipement. Couper le courant ou s'assurer que l'environnement est classé non dangereux avant de débrancher les connecteurs. Fixer tous les connecteurs externes reliés à cet équipement à l'aide de vis, loquets coulissants, connecteurs filetés ou autres moyens fournis avec ce produit. La substitution de composants peut rendre cet équipement inadapte à une utilisation en environnement de Classe I, Division 2. S'assurer que l'environnement est classé non dangereux avant de changer les piles.

Installing Your Relay Output Module

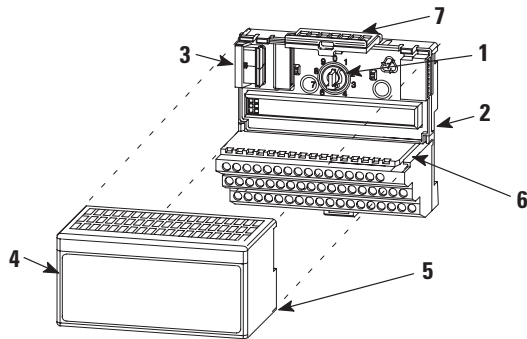

ATTENTION During mounting of all devices, be sure that all debris (metal chips, wire strands, etc.) is kept from falling into the module. Debris that falls into the module could cause damage on power up.

The module mounts on a 1794 terminal base.

1. Rotate the keyswitch (1) on the terminal base (2) clockwise to position 9 as required for this type of module.
2. Make certain the flexbus connector (3) is pushed all the way to the left to connect with the neighboring termbase/adaptor. You cannot install the module unless the connector is fully extended.

3. Make sure the pins on the bottom of the module are straight so they will align properly with the connector in the terminal base.

WARNING If you remove or insert the module while the backplane power is on, an electrical arc can occur. This could cause an explosion in hazardous location installations. Be sure that power is removed or the area is nonhazardous before proceeding.

4. Position the module (4) with its alignment bar (5) aligned with the groove (6) on the terminal base.
5. Press firmly and evenly to seat the module in the terminal base unit. The module is seated when the latching mechanism (7) is locked into the module.

Simplified Schematic of the 1794-OW8 Relay Module

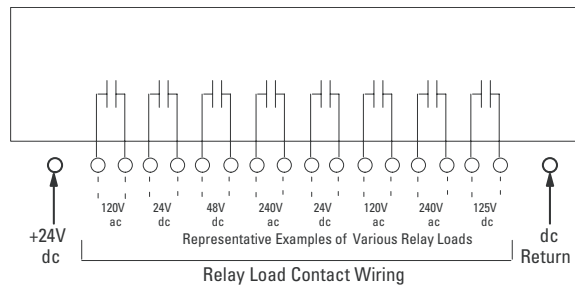

Load power can be obtained from a variety of sources, and can range from +5V to 240V ac. Make certain that only 24V dc is applied to the module power terminals on the module terminal base unit.

If you are using 220/240V ac power, you must use the 1794-TBN terminal base unit. Maximum voltage allowed is shown below.

Working Voltage for Terminal Base Units

Terminal Base 1794-	24V dc	120V ac	230V ac
TBN/TBNF			
TB2, TB3, TB3S			
TB3T, TB3TS			
TB3G, TB3GS			
TB32, TB32S			

ATTENTION Apply only 24V dc power to the power terminals on the terminal base unit. Make certain that all relay wiring is properly connected before applying any power to the module.

ATTENTION Total current through the terminal base unit is limited to 10A. Separate power connections to the terminal base unit may be necessary.

WARNING



Do not attempt to increase load current or wattage capability beyond the maximum rating by connecting 2 or more outputs in parallel. The slightest variation in relay switching time may cause one relay to momentarily switch the total load current.

ATTENTION



When using 240V power to a relay, you must connect a snubber across the load. Failure to connect a snubber across the load (relay contacts) can result in generation of electromagnetic noise which could disrupt nearby electrical equipment, including your 1794 FLEX I/O chassis. Use Allen-Bradley part number 599-KA04 or 1401-NX1.

Wiring to a 1794-TB2, -TB3 or -TB3S Terminal Base Unit

1. Connect individual output relay contact (customer load) wiring to numbered terminals on the **0-15 row (A)** as indicated in the table below. The even numbered terminals are one pole of the relay contacts; the odd numbered terminals are the other pole of the relay contacts.
2. Connect 24V dc return to terminal 16 on the **16-33 row (B)**.
3. Connect +24V dc power to terminal 34 on the **34-51 row (C)**.

ATTENTION



Apply only 24V dc power to the power terminals on the terminal base unit.
Make certain that **all** relay wiring is properly connected before applying any power to the module.

ATTENTION



Apply only 24V dc power to the power terminals on the terminal base unit.
Make certain that **all** relay wiring is properly connected before applying any power to the module.

4. If daisychaining power to the next terminal base, connect a jumper from terminal 51 (+V dc) on this base unit to terminal 34 on the next base unit.
5. If continuing dc common to the next base unit, connect a jumper from terminal 33 (common) on this base unit to terminal 16 on the next base unit.

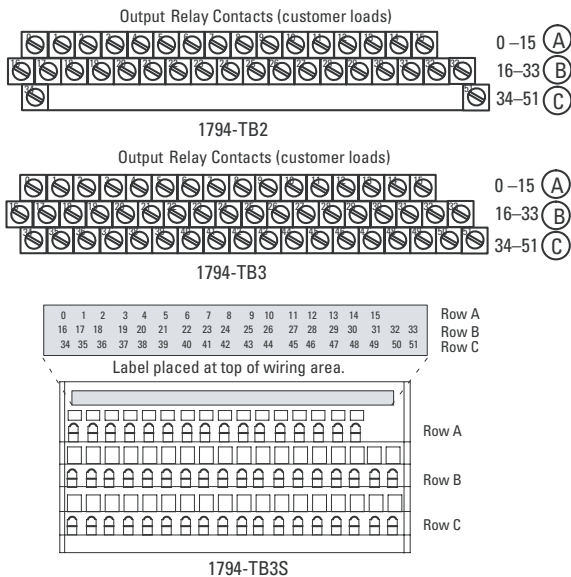
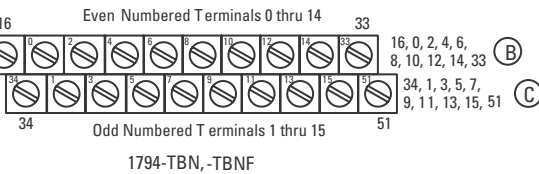

Wiring Connections for the 1794-OW8

Output Channel ¹	1794-TB2, -TB3, -TB3S	1794-TBN, -TBNF
	Output Terminal	Output Terminal
0	A-0	B-0
	A-1	C-1
1	A-2	B-2
	A-3	C-3
2	A-4	B-4
	A-5	C-5
3	A-6	B-6
	A-7	C-7
4	A-8	B-8
	A-9	C-9
5	A-10	B-10
	A-11	C-11
6	A-12	B-12
	A-13	C-13
7	A-14	B-14
	A-15	C-15
	A-(even) = one contact of the relay A-(odd) = the other contact of the relay	B-(even) = one contact of the relay C-(odd) = the other contact of the relay
+24V dc	C-34 thru C-51 (-TB3, -TB3S) C-34 and C-51 (-TB2)	C-34 and C- 51
-24V dc (RET)	B- 16 thru B-33	B-16 and B-33

Wiring to a 1794-TBN or -TBNF Terminal Base Unit

1. Connect individual output relay contact (customer load) to even numbered terminals (0 thru 14) on row **(B)** and odd numbered terminals (1 thru 15) on row **(C)** as indicated in the table below. The even numbered terminals are one pole of the relay contacts; the odd numbered terminals are the other pole of the relay contacts.

Image Table Memory Map

Dec.	1	1	1	1	1	1	0	0	0	0	0	0	0	0	0	0
	5	4	3	2	1	0	9	8	7	6	5	4	3	2	1	0
Oct.	1	1	1	1	1	1	1	1	0	0	0	0	0	0	0	0
	7	6	5	4	3	2	1	0	7	6	5	4	3	2	1	0
Read Word	Not used - reserved															
Write Word	Not used - set to 0															
									0	0	0	0	0	0	0	0
									7	6	5	4	3	2	1	0

Where: 0 = Output number (00 corresponds to output 0, 01 corresponds to output 1, and so on)
When bit = 0, output 0 is off, when bit 0 1, output 0 is on.

Installing or Changing a Fuse in the 1794-TBNF

This terminal base unit has fuse holders for 5X20mm fuses on each of the 8 even-numbered I/O terminals (0 thru 14 - row B). To install or change a fuse:

1. Press the fuse holder down toward the terminal strip.

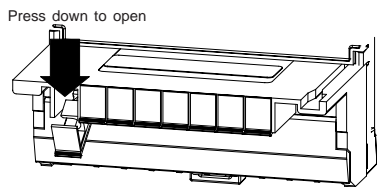

2. If replacing a fuse, remove the fuse from the fuse holder.
3. Insert a known good 5X20mm fuse (Littelfuse pt. no. 239003, 3.0A, 250V ac slow-blow) into the fuse holder.
4. Replace the fuse holder by rotating the fuse holder back to vertical until it snaps into the locked position.

Specifications - 1794-OW8 Relay Output Module

Outputs per Module	1 group of 8 Form A isolated (normally open) electromechanical relays
Module Location	Mounts on 1794-TB2, -TB3, -TB3S, -TBN and -TBNF Terminal Base Units. When using 1794-TBNF terminal base unit, use 3.0A, 250V ac slow-blow fuses (Littelfuse pt. no. 239003)
Off-State Leakage Current (max at 240V ac)	1.0mA thru snubber circuit
Minimum Contact Load	100µA at 100mV dc
Output Voltage Range (load dependent)	5-30V dc @ 2.0A resistive 48V dc @ 0.5A resistive 125V dc @ 0.25A resistive 125V ac @ 2.0A resistive 240V ac @ 2.0A resistive If used in European Zone 2 potentially explosive atmospheres, voltages must be at or below 60V ac or 75V dc.
Output Current Rating (at rated power)	Resistive 2A @ 5-30V dc 0.5A @ 48V dc 0.25A @ 125V dc 2A @ 125V ac 2A @ 240V ac Inductive 2.0A steady state @ 5-30V dc, L/R = 7ms 0.5A steady state @ 48V dc, L/R = 7ms 0.25A steady state @ 125V dc, L/R = 7ms 2.0A steady state, 15A make @ 125V ac, PF = cos θ = 0.4 2.0A steady state, 15A make @ 240V ac, PF = cos θ = 0.4
Power Rating (steady state)	250W max. for 125V ac resistive output 480W max. for 240V ac resistive output 60W max. for 30V dc resistive output 24W max. for 48V dc resistive output 31W max. for 125V dc resistive output 250VA max. for 125V ac inductive output 480VA max. for 240V ac inductive output 60VA max. for 30V dc inductive output 24VA max. for 48V dc inductive output 31VA max. for 125V dc inductive output
Output Signal Delay OFF to ON	10ms maximum (time from valid output on signal to relay energization by module)
ON to OFF	10ms maximum (time from valid output off signal to relay deenergization by module)
Initial Contact Resistance	30mΩ
Switching Frequency	1 operation/3s (0.3Hz at rated load) max
Bounce Time	1.2ms (mean)
Expected Life of Electrical Contacts	Minimum 100,000 operations @ rated loads
Flexbus Current	69mA maximum
Power Dissipation	5.5W
Thermal Dissipation	18.8 BTU/hr maximum
Isolation Voltage Between any 2 sets of contacts	Tested to the following: 2550V dc for 1s
Customer load to logic	2550V dc for 1s
Customer load to 24V dc supply	2550V dc for 1s
Customer 24V dc supply to logic	850V dc for 1s
Fusing	Fusing of outputs is recommended. Use 3.0A, 250V ac slow-blow fuses (Littelfuse pt. no. 239003).
Indicators	8 yellow status indicators - show status of individual outputs. If relay output bit is on, corresponding output indicator is on.
Keyswitch position	9
Terminal Screw Torque	7 pound-inches (0.8Nm); NEMA 1794-TBN, -TBNF: 9 pound-inches (1.02Nm)
Dimensions (with module installed)	3.7H x 3.7W x 2.7D inches 94H x 94W x 69D mm

Environmental Conditions	
Operating Temperature	IEC 60068-2-1 (Test Ad, Operating Cold), IEC 60068-2-2 (Test Bd, Operating Dry Heat), IEC 60068-2-14 (Test Nb, Operating Thermal Shock): 0 to 55°C (32 to 131°F)
Storage Temperature	IEC 60068-2-1 (Test Ab, Un-packaged Non-operating Cold), IEC 60068-2-2 (Test Bb, Un-packaged Non-operating Dry Heat), IEC 60068-2-14 (Test Na, Un-packaged Non-operating Thermal Shock): -40 to 85°C (-40 to 185°F)
Relative Humidity	IEC 60068-2-30 (Test Db, Unpackaged nonoperating Damp Heat): 5 to 95% noncondensing
Vibration	IEC 60068-2-27 (Test Fc, Operating): 5g @ 10-500Hz
Shock Operating Nonoperating	IEC 60068-2-6 (Test Ea, Unpackaged Shock): 12g 50g
ESD Immunity	IEC 61000-4-2: 4kV contact discharges 8kV air discharges
Radiated RF Immunity	IEC 61000-4-3: 10V/m with 1kHz sine-wave 80%AM from 30MHz to 1000MHz
EFT/B Immunity	IEC 61000-4-4: ±2kV at 5kHz on signal ports
Surge Transient Immunity	IEC 61000-4-5: ±1kV line-line(DM) and ±2kV line-earth(CM) on signal ports
Conducted RF Immunity	IEC 61000-4-6: 10Vrms with 1kHz sine-wave 80%AM from 150kHz to 80MHz
Emissions	CISPR 11: Group 1, Class A (with appropriate enclosure)
Enclosure Type Rating	None (open-style)
Conductors/Wire Size	12AWG (4mm ²) maximum stranded copper wire rated at 75°C or higher 3/64 inch (1.2mm) insulation maximum
Category ¹	1
Certifications (when product is marked) ²	UL UL Listed Industrial Control Equipment CSA CSA certified Process Control Equipment CSA CSA certified Process Control Equipment for Class I, Division 2, Groups A, B, C and D Hazardous locations EEx² European Union 94/9/EEC ATEX Directive, compliant with: EN 50021; Potentially Explosive Atmospheres, Protection "n" (Zone 2) when used at or below 60V ac or 75V dc CE² European Union 89/336/EEC EMC Directive, compliant with: EN 61000-6-4; Industrial Emissions EN 50082-2; Industrial Immunity EN 61326; Meas./Control/Lab., Industrial Requirements EN 61000-6-2; Industrial Immunity CE² European Union 73/23/EEC LVD Directive, compliant with: 61131-2 - Programmable Controllers C-Tick² Australian Radiocommunications Act compliant with AS/NZS CISPR 11, Industrial Emissions

¹ You use this category information for planning conductor routing as described in Allen-Bradley publication 1770-4.1, Industrial Automation Wiring and Grounding Guidelines.

² For the latest up-to-date information, see the Product Certification link at www.ab.com for Declarations of Conformity, Certificates and other certification details. For notification of any additional release notes, refer to www.ab.com/manuals/.

www.rockwellautomation.com

Corporate Headquarters

Rockwell Automation, 777 East Wisconsin Avenue, Suite 1400, Milwaukee, WI, 53202-5302 USA, Tel: (1) 414.212.5200, Fax: (1) 414.212.5201

Headquarters for Allen-Bradley Products, Rockwell Software Products and Global Manufacturing Solutions

Americas: Rockwell Automation, 1201 South Second Street, Milwaukee, WI 53204-2496 USA, Tel: (1) 414.382.2000, Fax: (1) 414.382.4444

Europe: Rockwell Automation SA/NV, Vorstlaan/Boulevard du Souverain 36-BP 3A/B, 1170 Brussels, Belgium, Tel: (32) 2 663 0600, Fax: (32) 2 663 0640

Asia Pacific: Rockwell Automation, 27/F Citicorp Centre, 18 Whitfield Road, Causeway Bay, Hong Kong, Tel: (852) 2887 4788, Fax: (852) 2508 1846

Headquarters for Dodge and Reliance Electric Products

Americas: Rockwell Automation, 6040 Ponders Court, Greenville, SC 29615-4617 USA, Tel: (1) 864.297.4800, Fax: (1) 864.281.2433

Europe: Rockwell Automation, Brühlstraße 22, D-74834 Elztal-Dallau, Germany, Tel: (49) 6261 9410, Fax: (49) 6261 17741

Asia Pacific: Rockwell Automation, 55 Newton Road, #11-01/02 Revenue House, Singapore 307987, Tel: (65) 351 6723, Fax: (65) 355 1733

Publication 1794-IN019C-EN-P - June 2003

Supersedes Publication 1794-IN019B-EN-P - November 2002

PN 957782-75

Copyright © 2003 Rockwell Automation, Inc. All rights reserved. Printed in the U.S.A.