

Power and productivity  
for a better world™



Trace back information:

Workspace R15-1 version a3

Checked in 2015-03-25

Skribenta version 4.1.349

Application manual  
DeviceNet Master/Slave

RobotWare 6.01

Document ID: 3HAC050992-001

Revision: A

The information in this manual is subject to change without notice and should not be construed as a commitment by ABB. ABB assumes no responsibility for any errors that may appear in this manual.

Except as may be expressly stated anywhere in this manual, nothing herein shall be construed as any kind of guarantee or warranty by ABB for losses, damages to persons or property, fitness for a specific purpose or the like.

In no event shall ABB be liable for incidental or consequential damages arising from use of this manual and products described herein.

This manual and parts thereof must not be reproduced or copied without ABB's written permission.

Additional copies of this manual may be obtained from ABB.

The original language for this publication is English. Any other languages that are supplied have been translated from English.

? Copyright 2013-2015 ABB. All rights reserved.

ABB AB  
Robotics Products  
Se-721 68 V?ster?s  
Sweden

# Table of contents

Overview of this manual .....	7
Product documentation, IRC5 .....	9
Safety .....	11
Network security .....	12
Terminology .....	13
<b>1 Introduction</b> .....	<b>15</b>
1.1 What is DeviceNet? .....	15
1.2 DeviceNet for IRC5 .....	17
<b>2 Hardware overview</b> .....	<b>19</b>
2.1 Main computer DSQC1000 .....	19
2.2 Cables and connections .....	21
2.2.1 Shield grounding and power .....	21
2.2.2 Termination resistors .....	23
2.2.3 Cabling .....	24
2.2.4 Selecting cables .....	25
2.2.5 Repeaters .....	26
2.3 Devices .....	28
<b>3 Software overview</b> .....	<b>29</b>
3.1 Information about the internal slave device .....	29
3.2 Information about the internal master .....	31
<b>4 Configuring the internal slave device</b> .....	<b>33</b>
4.1 Recommended working procedure .....	33
4.2 Configuring the internal slave device .....	34
4.3 Configuring the external master .....	36
<b>5 Configuring the internal master</b> .....	<b>37</b>
5.1 Recommended working procedure .....	37
5.2 Configuring the IRC5 controller .....	38
5.2.1 Manual configuration of I/O devices in RobotStudio .....	39
5.2.2 Manual configuration of I/O devices after a network scan .....	41
5.2.3 Automatic configuration of I/O devices .....	42
5.2.4 Configuration of third party devices .....	43
5.3 Communication between two IRC5 controllers .....	45
<b>6 Boards and devices</b> .....	<b>47</b>
6.1 General .....	47
6.1.1 DeviceNet network and I/O board status LED description .....	47
6.1.2 DeviceNet network status LEDs at power-up .....	49
6.1.3 External devices .....	50
6.1.4 Coil neutralization .....	51
6.1.5 Setting DeviceNet network ID .....	52
6.2 Device descriptions .....	54
6.2.1 Introduction .....	54
6.2.2 DSQC 351B, DeviceNet/INTERBUS gateway .....	55
6.2.3 DSQC 377B, Queue tracking device .....	62
6.2.4 DSQC 378B, DeviceNet/CCLink gateway .....	71
6.2.5 DSQC 651, AD combi I/O .....	79
6.2.6 DSQC 652, Digital I/O .....	85
6.2.7 DSQC 653, Digital I/O with relay outputs .....	91

# Table of contents

---

7	System parameters	97
7.1	Introduction .....	97
7.2	Type Industrial Network .....	99
7.2.1	Address .....	99
7.2.2	DeviceNet Communication Speed .....	100
7.3	Type DeviceNet Device .....	101
7.3.1	Address .....	101
7.3.2	Vendor ID .....	102
7.3.3	Product Code .....	103
7.3.4	Device Type .....	104
7.3.5	Production Inhibit Time .....	105
7.3.6	Connection Type .....	106
7.3.7	Poll Rate .....	107
7.3.8	Connection Output Size .....	108
7.3.9	Connection Input Size .....	109
7.3.10	Quick Connect .....	110
7.4	Type DeviceNet Internal Device .....	111
7.4.1	Connection Input Size .....	111
7.4.2	Connection Output Size .....	112
7.5	Type DeviceNet Command .....	113
7.5.1	Path .....	113
7.5.2	Service .....	115
8	Trouble shooting	117
8.1	Bus off .....	117
8.2	Bus Scan .....	118
	Index	119

---

# Overview of this manual

## About this manual

This manual describes the option DeviceNet Master/Slave and contains instructions for the configuration. It also describes the configuration of boards and devices.

## Usage

This manual should be used during installation and configuration of the DeviceNet network and upgrading of the option DeviceNet Master/Slave.

## Who should read this manual?

This manual is intended for:

- ? Personnel that are responsible for installations and configurations of industrial network hardware/software
- ? Personnel that make the configurations of the I/O system
- ? System integrators

## Prerequisites

The reader should have the required knowledge of:

- ? Mechanical installation work
- ? Electrical installation work
- ? System parameter configuration

## References

### Document references

References	Document ID
Application manual - DeviceNet Anybus Slave	3HAC050993-001
Application manual - Conveyor tracking	3HAC050991-001
Application manual - EtherNet/IP Anybus Adapter	3HAC050997-001
Application manual - Controller software IRC5	3HAC050798-001
Operating manual - IRC5 with FlexPendant	3HAC050941-001
Operating manual - RobotStudio	3HAC032104-001
Product manual - IRC5	3HAC047136-001
Product specification - Controller IRC5 with FlexPendant	3HAC041344-001
Technical reference manual - System parameters	3HAC050948-001
Technical reference manual - RAPID Instructions, Functions and Data types	3HAC050917-001

### Other references

References	Description
<a href="http://www.odva.org">www.odva.org</a>	The web site of ODVA (Open DeviceNet Vendor Association).

Continues on next page

## Overview of this manual

---

Continued

References	Description
ODVA DeviceNet Specification, revision 2.0	Specification from ODVA (Open DeviceNet Vendor Associations).

---

## Revisions

Revision	Description
-	First edition. Released with RobotWare 6.0.
A	Released with RobotWare 6.01. ? Minor corrections. ? System parameter Connection removed from Industrial Network .



# Product documentation, IRC5

---

## Categories for user documentation from ABB Robotics

The user documentation from ABB Robotics is divided into a number of categories. This listing is based on the type of information in the documents, regardless of whether the products are standard or optional.

All documents listed can be ordered from ABB on a DVD. The documents listed are valid for IRC5 robot systems.

---

## Product manuals

Manipulators, controllers, DressPack/SpotPack, and most other hardware is delivered with a Product manual that generally contains:

- ? Safety information.
  - ? Installation and commissioning (descriptions of mechanical installation or electrical connections).
  - ? Maintenance (descriptions of all required preventive maintenance procedures including intervals and expected life time of parts).
  - ? Repair (descriptions of all recommended repair procedures including spare parts).
  - ? Calibration.
  - ? Decommissioning.
  - ? Reference information (safety standards, unit conversions, screw joints, lists of tools).
  - ? Spare parts list with exploded views (or references to separate spare parts lists).
  - ? Circuit diagrams (or references to circuit diagrams).
- 

## Technical reference manuals

The technical reference manuals describe reference information for robotics products.

- ? Technical reference manual - Lubrication in gearboxes : Description of types and volumes of lubrication for the manipulator gearboxes.
- ? Technical reference manual - RAPID overview : An overview of the RAPID programming language.
- ? Technical reference manual - RAPID Instructions, Functions and Data types : Description and syntax for all RAPID instructions, functions, and data types.
- ? Technical reference manual - RAPID kernel : A formal description of the RAPID programming language.
- ? Technical reference manual - System parameters : Description of system parameters and configuration workflows.

---

Continues on next page

Continued

#### Application manuals

Specific applications (for example software or hardware options) are described in Application manuals . An application manual can describe one or several applications.

An application manual generally contains information about:

- ? The purpose of the application (what it does and when it is useful).
- ? What is included (for example cables, I/O boards, RAPID instructions, system parameters, DVD with PC software).
- ? How to install included or required hardware.
- ? How to use the application.
- ? Examples of how to use the application.

#### Operating manuals

The operating manuals describe hands-on handling of the products. The manuals are aimed at those having first-hand operational contact with the product, that is production cell operators, programmers, and trouble shooters.

The group of manuals includes (among others):

- ? Operating manual - Emergency safety information
- ? Operating manual - General safety information
- ? Operating manual - Getting started, IRC5 and RobotStudio
- ? Operating manual - Introduction to RAPID
- ? Operating manual - IRC5 with FlexPendant
- ? Operating manual - RobotStudio
- ? Operating manual - Trouble shooting IRC5, for the controller and manipulator.

# Safety

---

## Safety of personnel

When working inside the robot controller it is necessary to be aware of voltage-related risks.

A danger of high voltage is associated with the following parts:

- ? Devices inside the controller, for example I/O devices, can be supplied with power from an external source.
- ? The mains supply/mains switch.
- ? The power unit.
- ? The power supply unit for the computer system (230 VAC).
- ? The rectifier unit (400-480 VAC and 700 VDC). Capacitors!
- ? The drive unit (700 VDC).
- ? The service outlets (115/230 VAC).
- ? The power supply unit for tools, or special power supply units for the machining process.
- ? The external voltage connected to the controller remains live even when the robot is disconnected from the mains.
- ? Additional connections.

Therefore, it is important that all safety regulations are followed when doing mechanical and electrical installation work.

---

## Safety regulations

Before beginning mechanical and/or electrical installations, ensure you are familiar with the safety regulations described in Operating manual - General safety information <sup>1</sup>.

<sup>1</sup> This manual contains all safety instructions from the product manuals for the manipulators and the controllers.

## Network security

---

### Network security

This product is designed to be connected to and to communicate information and data via a network interface, It is your sole responsibility to provide and continuously ensure a secure connection between the product and to your network or any other network (as the case may be). You shall establish and maintain any appropriate measures (such as but not limited to the installation of firewalls, application of authentication measures, encryption of data, installation of anti-virus programs, etc) to protect the product, the network, its system and the interface against any kind of security breaches, unauthorized access, interference, intrusion, leakage and/or theft of data or information. ABB Ltd and its entities are not liable for damages and/or losses related to such security breaches, any unauthorized access, interference, intrusion, leakage and/or theft of data or information.

# Terminology

## Terms

Term	Explanation
Slave	I/O device that is controlled by a master in a DeviceNet network.
Internal Slave Device	A built-in device in the robot controller.
CIP	Common Industrial Protocol. Protocol that DeviceNet and EtherNet/IP are based on.
Client	See term Master . Some documents use the term client , whereas the ABB documentation use the term Master for DeviceNet industrial network.
EDS	Electronic Data Sheet. EDS files contain the configuration details relevant to CIP devices.
Explicit Messages	An explicit message is a request or response oriented communication with other devices. These messages are mostly configuration data.
Master	Controls other devices (nodes) in a DeviceNet network.
ODVA	Open DeviceNet Vendor Association. Organization for networks built on CIP, for example DeviceNet and EtherNet/IP.
Server	See term Slave . Some documents use the term server , whereas the ABB documentation use the term slave for DeviceNet network.

This page is intentionally left blank

# 1 Introduction

## 1.1 What is DeviceNet?

### General

DeviceNet is a communications link to connect industrial devices. It is a simple networking solution that reduces both cost and time to wire and install industrial automation devices, and the direct connectivity provides improved communication between devices. DeviceNet is an open network standard.

Here are some examples of applications:

- ? Peer-to-peer data exchange where a DeviceNet product can produce and consume messages
- ? Master/slave operation defined as a proper subset of Peer-to-Peer
- ? A DeviceNet product can function as a client or server, or both

### DeviceNet specification

The DeviceNet specification defines a network communication system for moving data between elements of an industrial control system.

### Communication protocol connections

The user must establish a connection with a device in order to exchange information with that device.

DeviceNet defines the following two different types of messaging:

Type of message	Description
Explicit messages	Explicit messages provide multi-purpose and point-to-point communication paths between two devices. Explicit messages provide the typical request/response oriented network communications used to perform node configuration and problem diagnosis.
I/O messages	I/O messages are for time-critical and control-oriented data, and they provide a dedicated and special-purpose communication path between a producing application and one or more consuming applications.

### I/O messages - connection types

The following table describes the different types of I/O connections:

Type of I/O connection	Description
Polled connection	This technique is used for any amount of I/O data. Each slave receives a query from the master and may or may not respond before the next device has received a query. A slave can only respond to a request from the master.
Strobe connection	A single multicasting request. Quick exchange of a small amount of I/O data between a master and its slaves. The master sends one message that contains one bit of output data to each slave that has a strobe connection. This will result in a synchronized reading of data.

Continues on next page

# 1 Introduction

---

## 1.1 What is DeviceNet?

Continued

Type of I/O connection	Description
Change-Of-State (COS) connection	Devices are configured to produce data upon a change of I/O data. This technique can improve system throughput significantly. Data messages must be acknowledged by the receiver before new messages can be sent. Heart beat messages are used to tell the receiver that the device is still alive even if no data has changed state for a long time.
Cyclic connection	Devices are configured to produce data on a pre-configured time interval. Data production messages must be acknowledged before a new message can be sent.
Change-Of-State with acknowledge suppression	Devices are configured to produce data upon a change of application data. This technique can improve system throughput significantly. No acknowledge is required - that is, the receiver of data must be able to consume the data at the same rate as it is produced by the sending device.
Cyclic with acknowledge suppression	Devices are configured to produce data on a pre-configured time interval. No acknowledge is required - that is, the receiver of data must be able to consume the data at the same rate as it is produced by the sending device.



## 1.2 DeviceNet for IRC5

### General

The DeviceNet network for IRC5 is running on a single channel PCI Express board in the IRC5 main computer.

The DeviceNet board, DSQC1006, requires the main computer DSQC1000.

### Options

With option DeviceNet Master/Slave, the IRC5 controller can act as a master, slave, or both on the DeviceNet network.



#### Note

Note that the network settings are shared between the slave and the master if the IRC5 controller acts as both on the DeviceNet network.



#### Note

If only DeviceNet slave functionality is required, then the option DeviceNet Anybus Slave can also be used.

For more information see Application manual - DeviceNet Anybus Slave.

### Devices

Several I/O devices and gateways for DeviceNet communication are available from ABB, see Device descriptions on page 54.

### Specification overview

Item	Specification
Industrial Network type	DeviceNet
Specification revision	DeviceNet specification release 2.0
Data rate	125, 250, 500 Kbps
Support for predefined Master/Slave connection set	Group 2 Client (Master) Group 2 Only Client (Master) Group 2 Server (Internal device)

This page is intentionally left blank

## 2 Hardware overview

### 2.1 Main computer DSQC1000

#### Connections

The I/O network is connected to the DeviceNet PCI Express board, DSQC1006, on the main computer. The DeviceNet PCI Express board is a single channel board that can act both as a master and a slave simultaneously on the DeviceNet network. The following figure illustrates the location of the PCI Express board in the main computer unit.

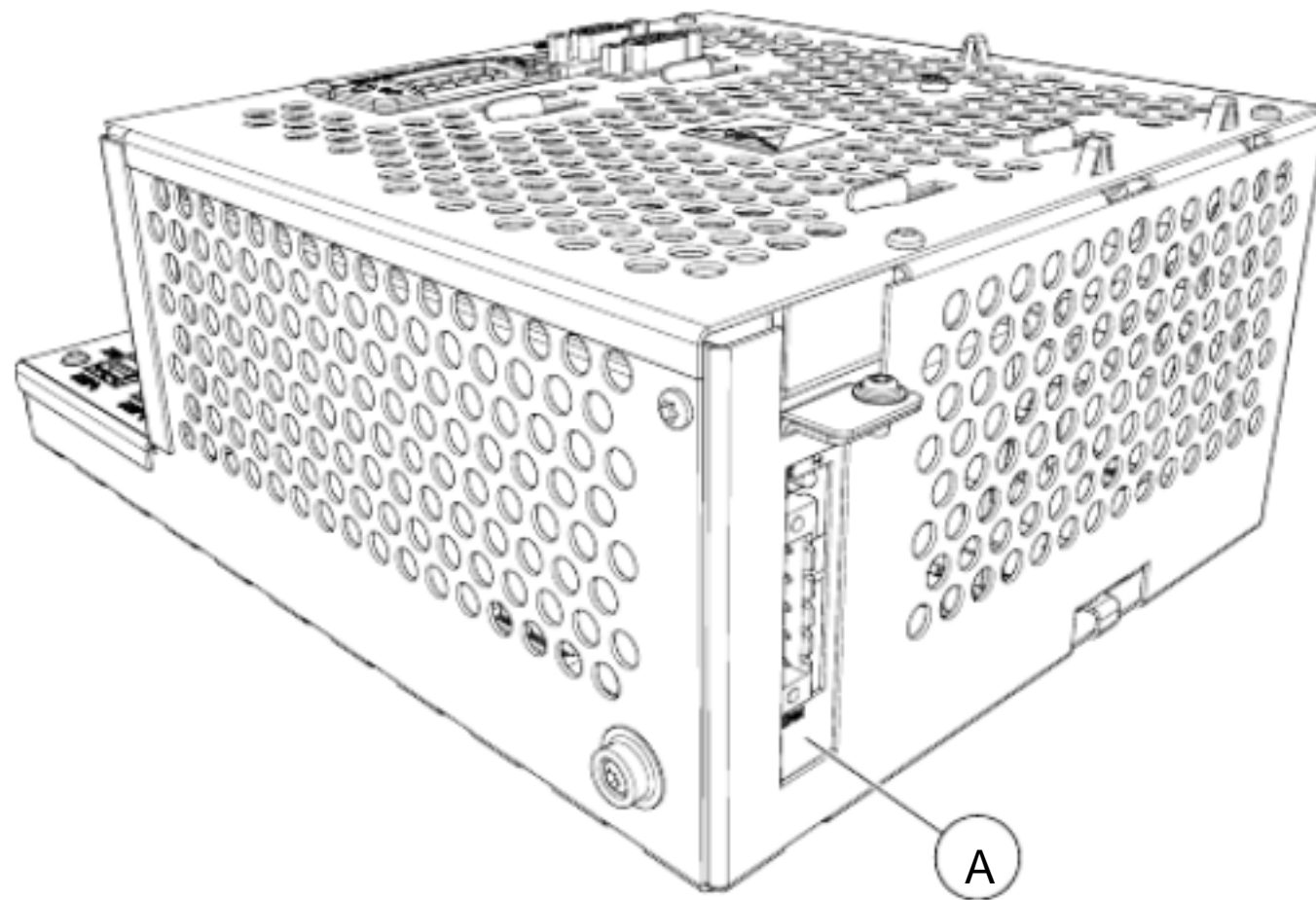

xx1300001968

	Description	Designation	Art. no.
A	DeviceNet Master/Slave PCI Express	DSQC1006	3HAC043383-001

#### Installation of PCI Express board

For information on how to install and replace the PCI Express board, see Product manual - IRC5.

#### The DeviceNet connector



xx0200000292

Continues on next page

## 2 Hardware overview

### 2.1 Main computer DSQC1000

Continued

The following table shows the connections to the DeviceNet connector:

I/O pin	Signal name	Wire color	Function
1	V-	black	DeviceNet network negative power (0 V)
2	CANL	blue	DeviceNet communication network terminal (low)
3	Shield	bare	Network cable shield
4	CANH	white	DeviceNet communication network terminal (high)
5	V+	red	DeviceNet network positive power (24 V DC)

### LEDs on the DeviceNet PCI Express board

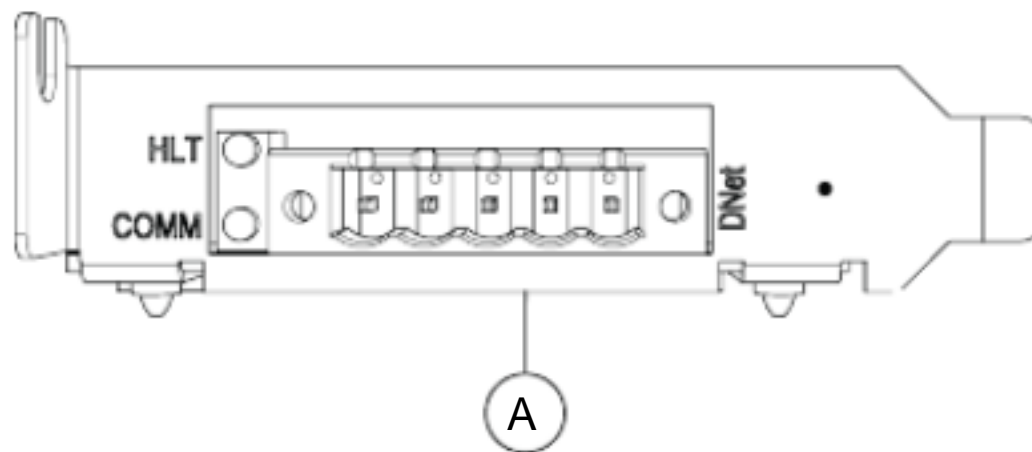

xx130000697

Designation	Color status	Description
COMM	Off	Offline - that is, board is not communicating on the network.
COMM	Flashing green	Online - that is, board is communicating on the network but no configured devices are found.
COMM	Solid green	Online and configured - that is, board is communicating on the network and at least one configured device is found.
COMM	Solid red	Bus off - that is, board unable to communicate on network.
HLT	Off	No power supply to PCI network.
HLT	Solid green	Board is running. Start-up self test OK.
HLT	Solid red	Board is not running, an error occurred during board firmware load or a fatal runtime error occurred.
		 Note This LED should be lit red at start-up until the proper software is loaded.

## 2.2 Cables and connections

## 2.2.1 Shield grounding and power

## General

The DeviceNet shield and V- should be interconnected and grounded at only one place in the DeviceNet network. For more advanced connections with several power supplies refer to the DeviceNet Specification, see References on page 7.

## Power supply

The DeviceNet network needs to be powered by a separate power supply. The power supply can be located either inside or outside of the IRC5 controller. Some I/O devices may also require separate power supply for the I/O signals.

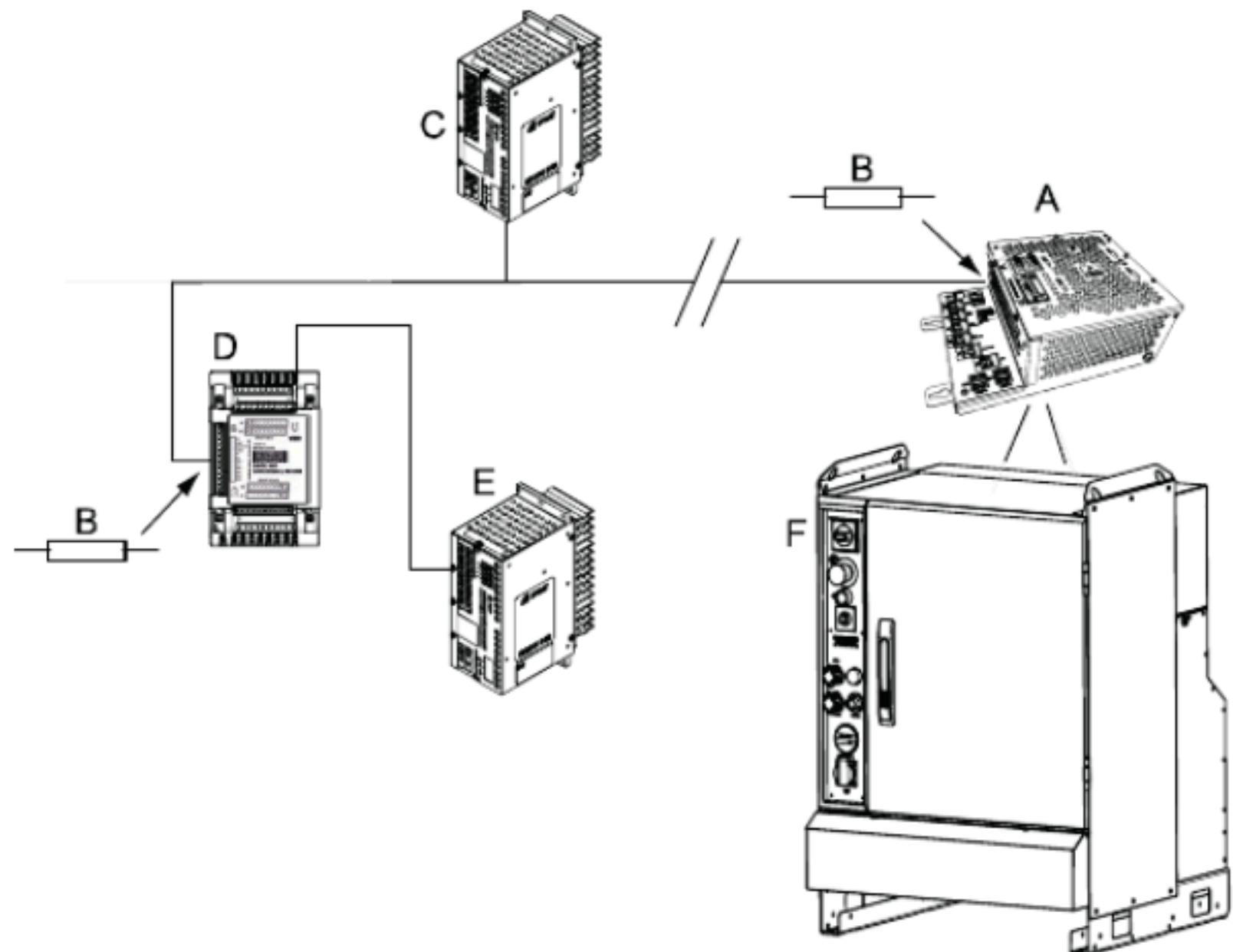

xx1300000696

A	DeviceNet master/slave board, placed in the computer module.
B	Terminating resistors (121 Ohm).
C	24 VDC power supply, for the network.
D	Distributed digital I/O device.
E	24 VDC power supply, for the I/O signals of the device.
F	IRC5 controller.

Continues on next page

## 2 Hardware overview

---

### 2.2.1 Shield grounding and power

Continued

#### Grounding

The following illustration shows an example of cable grounding:

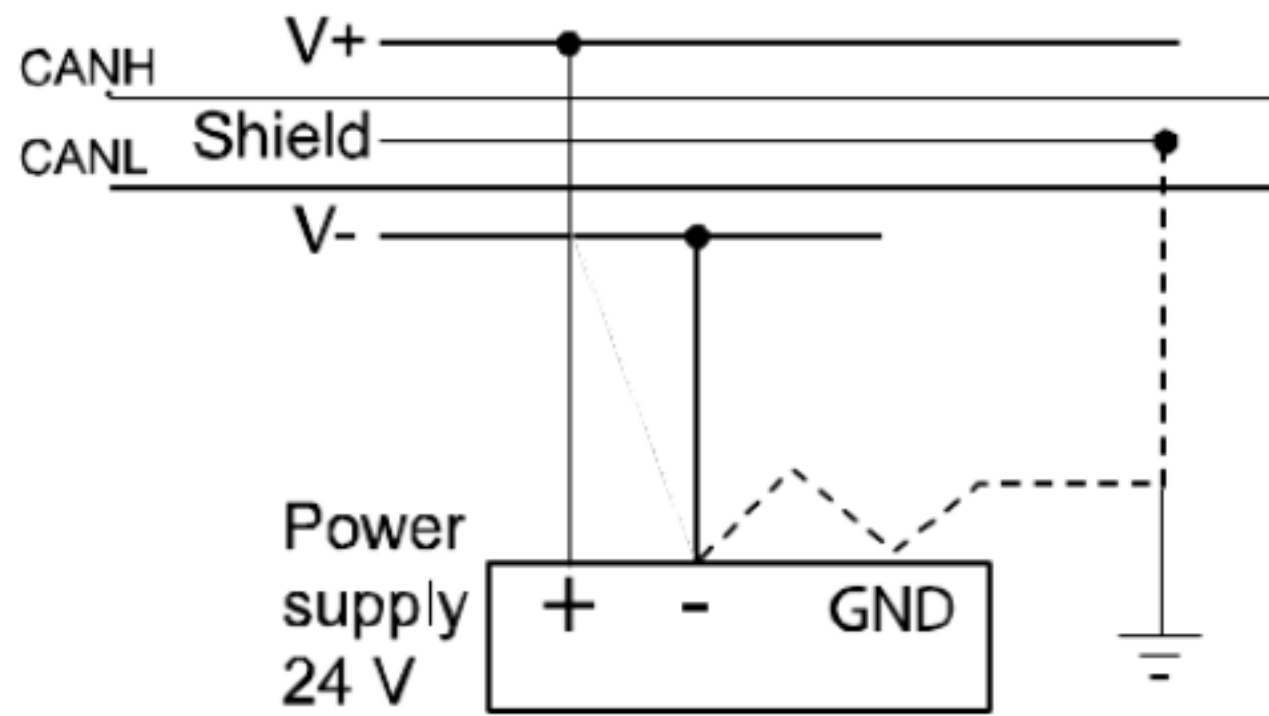

xx0300000525

## 2.2.2 Termination resistors

## General

Each end of the DeviceNet network must be terminated with a 121 ohm resistor. The two terminating resistors should be as far apart as possible.

The technical specification of the termination resistor is:

? 121 ohm, 1 %, 0.25 W metal film resistor

The termination resistor is placed in the cable connector. There is no internal termination on the DeviceNet PCI Express board.

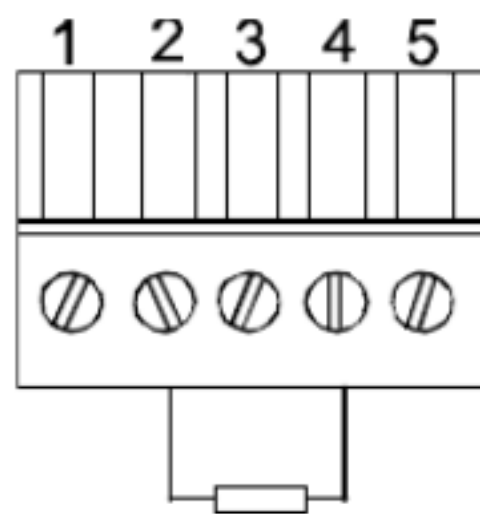

xx0400000674

## Illustration

The illustration below shows an example of how to terminate the DeviceNet network.

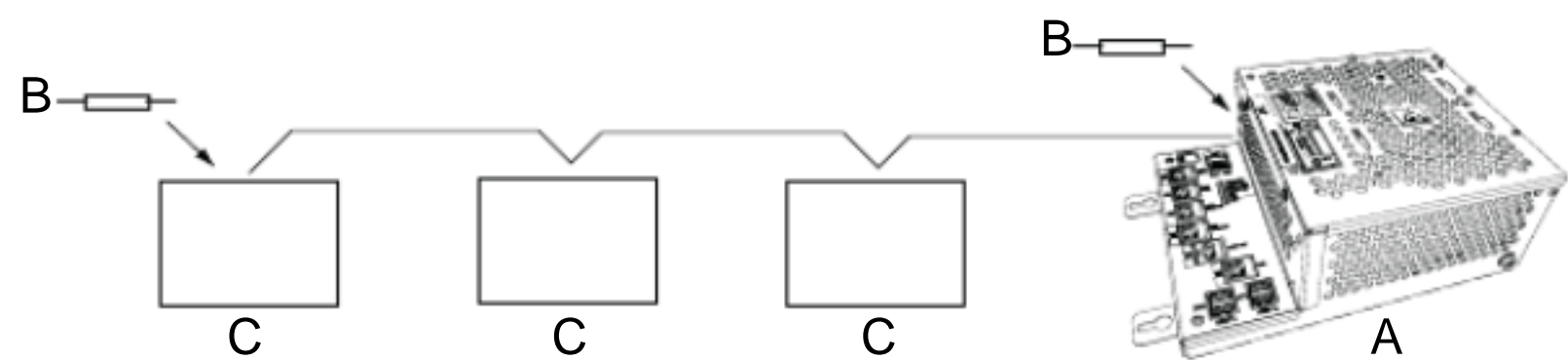

xx1300000698

A	DeviceNet PCI Express board.
B	Termination resistor
C	I/O device

2.2.3 Cabling

Physical connection between DeviceNet network and DeviceNet device

The following figure shows how the next DeviceNet node is connected to the DeviceNet network:

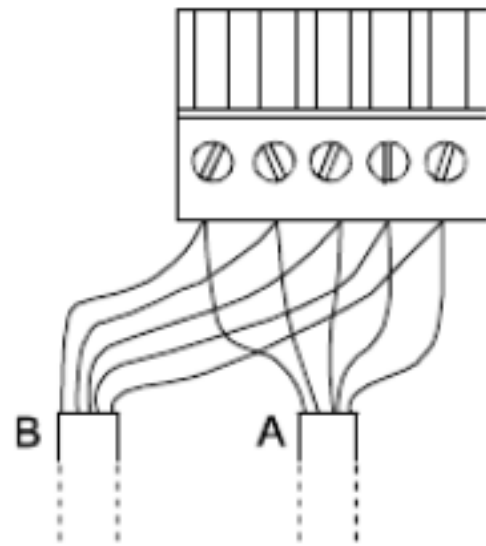

xx0400000849

A	Incoming DeviceNet network cable
B	Outgoing DeviceNet network cable

Illustration of trunk line and drop lines

The following figure illustrates a trunk line with drop lines. Thick or thin cable can be used for trunk lines and drop lines. For information about cable thickness and data rate, see the tables in the section Selecting cables on page 25.

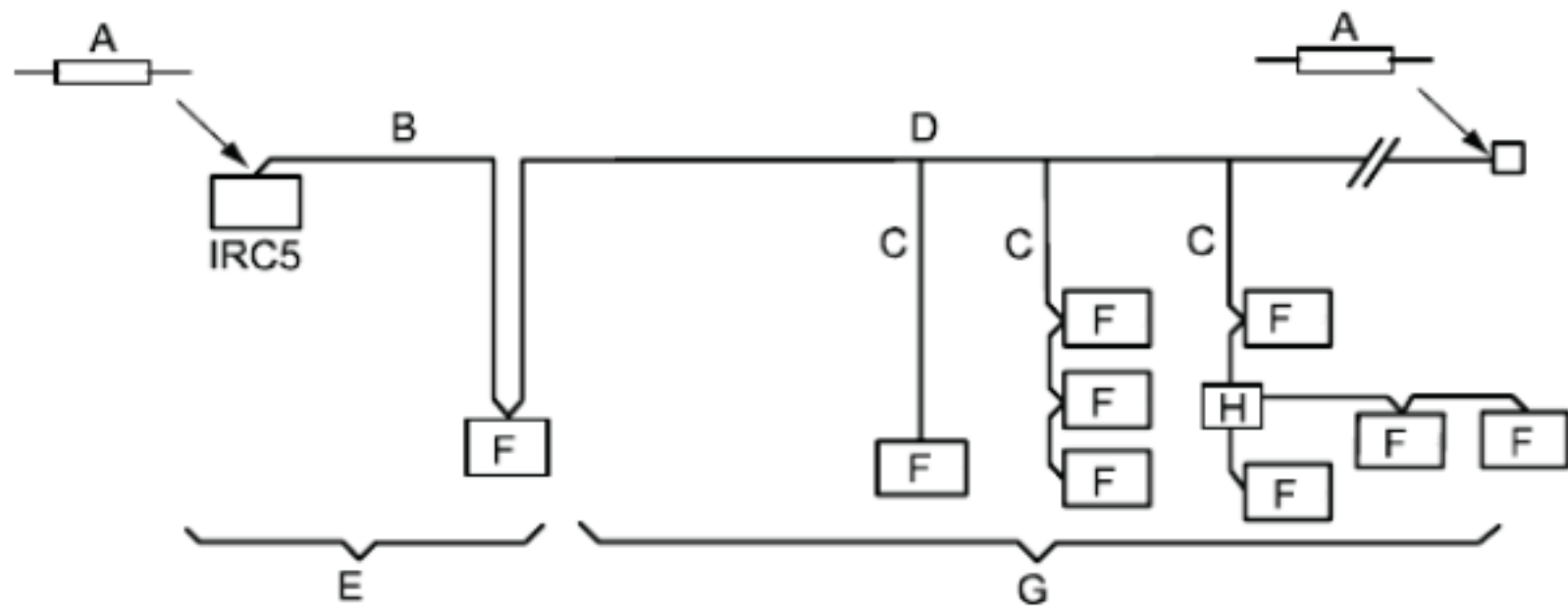

xx0300000579

A	Terminator
B	Trunk line
C	Drop line
D	Tap
E	Zero drop
F	Node
G	Short drop
H	T-connector



## 2.2.4 Selecting cables

## DeviceNet network

The end-to-end network distance varies with data rate and cable thickness. For information about cable length dependency on cable type and data rate, see the following tables. For specification of the designations on the different cable types, see ODVA DeviceNet Specification .

## Data rate 500 kbit/s

Cable type	Max. length
Thick trunk length	100 m (328 ft)
Thin trunk length	100 m (328 ft)
Flat trunk cable	75 m (246 ft)
Maximum drop length	6 m (20 ft)
Cumulative drop length	39 m (128 ft)

## Data rate 250 kbit/s

Cable type	Max. length
Thick trunk length	250 m (820 ft)
Thin trunk length	100 m (328 ft)
Flat trunk cable	200 m (656 ft)
Maximum drop length	6 m (20 ft)
Cumulative drop length	78 m (256 ft)

## Data rate 125 kbit/s

Cable type	Max. length
Thick trunk length	500 m (1,640 ft)
Thin trunk length	100 m (328 ft)
Flat trunk cable	380 m (1,250 ft)
Maximum drop length	6 m (20 ft)
Cumulative drop length	156 m (512 ft)

### 2.2.5 Repeaters

---

#### Usage

Repeaters are used for the following purposes:

- ? To avoid disturbances such as ESD/EFT, which may otherwise propagate to other parts of the network.
- ? To isolate noisy segments.
- ? When using several power supplies a repeater could be used to isolate the supplies from each other to avoid voltage potential differences and ground currents.

#### Extending the length of a trunk line

The following figure illustrates an application example where a repeater is used for extending the length of a trunk line:

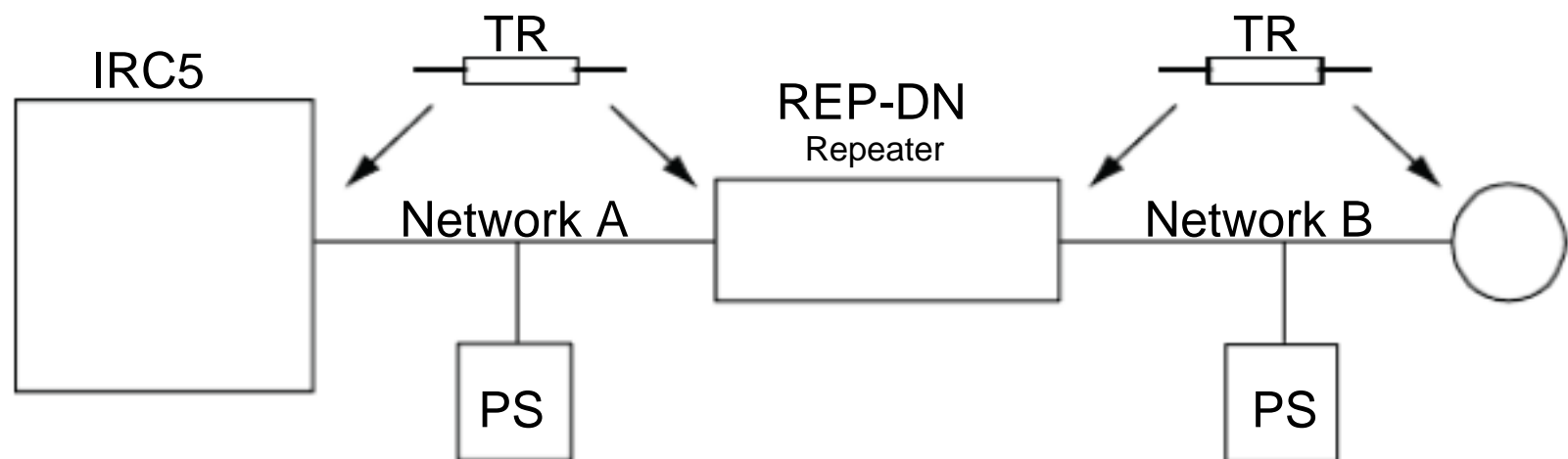

en040000724

Control	Controller
TR	Terminating resistor
PS	Power supply

Extending the length of a drop line

The following figure illustrates an application example where a repeater is used for extending the length of a drop line:

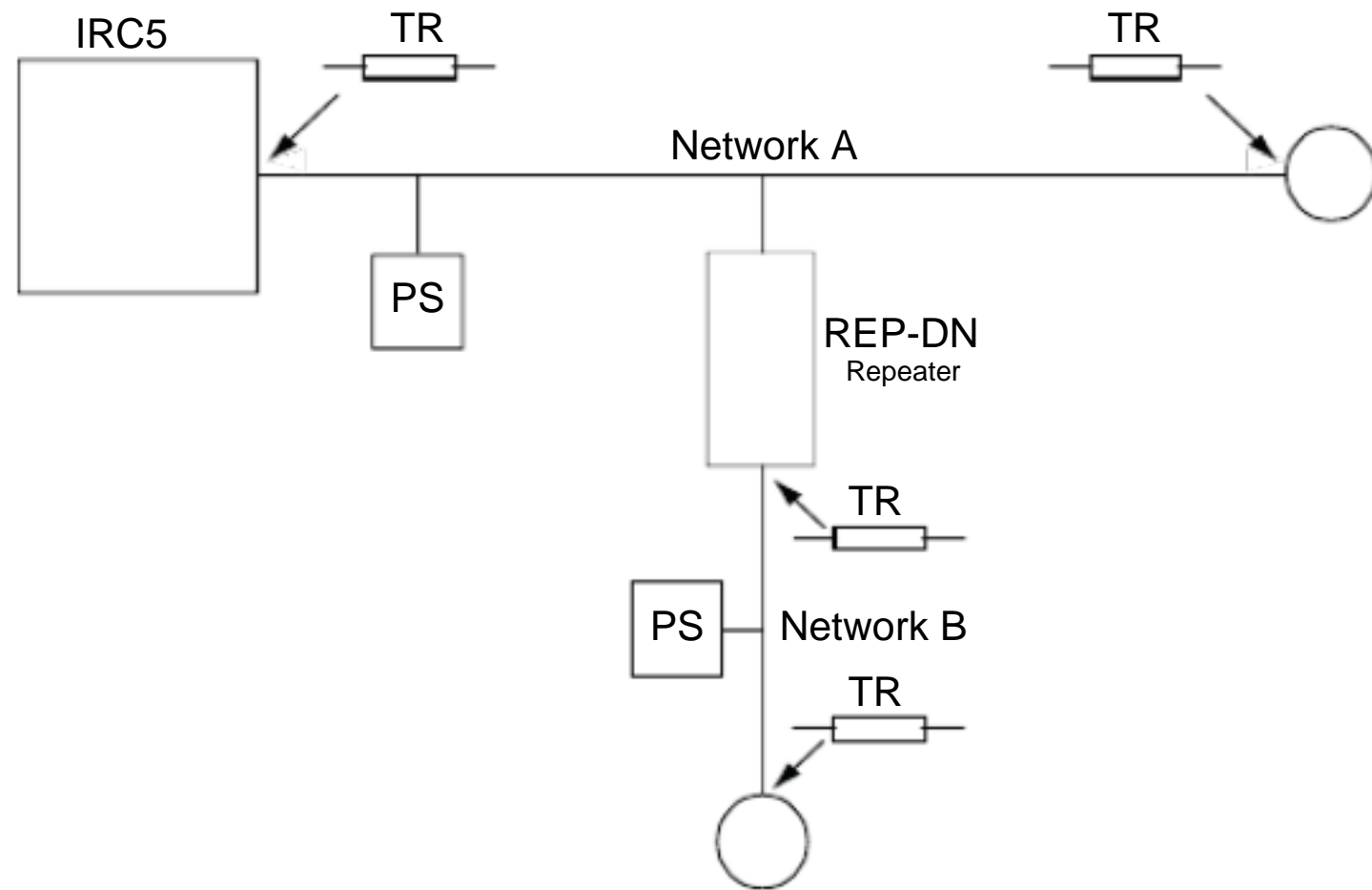

en0400000725

Control	Controller
TR	Terminating resistor
PS	Power supply

### 2.3 Devices

---

#### General

It is possible to connect any type of DeviceNet compliant device on the DeviceNet master network. All devices should comply with the DeviceNet standard and be conformance tested by ODVA.

Devices may be mounted inside the controller.

For details about devices, see Boards and devices on page 47.

---

#### Further information

The table gives references to additional information:

Information	See
Detailed descriptions of all devices and gateways available from ABB Robotics and that support DeviceNet communication.	Section Device descriptions on page 54.
How to install the devices and gateways mechanically and electrically.	Product manual - IRC5
Allowed configurations of devices and how to setup the configurations.	Technical reference manual - System parameters.

---

## 3 Software overview

### 3.1 Information about the internal slave device

---

#### General

To use the DeviceNet internal slave device, the IRC5 controller must be installed with the option 709-1 DeviceNet Master/Slave .

The DeviceNet internal slave device can be used to:

- ? connect the IRC5 controller to a PLC.
- ? connect the IRC5 controller to another IRC5 controller which acts as a master.

The DeviceNet internal slave device shares address and physical connector with the master.

---

#### Predefined Network

When the robot system is installed with the DeviceNet option, a predefined industrial network with the name DeviceNet is created at system startup.

---

#### Predefined internal slave device

When the robot system is installed with the DeviceNet Master/Slave option, a predefined internal slave device with the name DN\_Internal\_Device is created at system startup.

---

#### EDS file

An Electronic Data Sheet file, EDS file, is available for the internal slave device, matching the configuration of the predefined internal slave device.

The EDS file, IRC5\_Slave\_DSQC1006.eds , for the internal slave device can be obtained from the PC or the IRC5 controller.

- ? On the PC where the RobotWare is installed :  
    %LocalAppData%\ABB Industrial IT\Robotics
  
- ? On the IRC5 Controller :



#### Note

%LocalAppData% is located in the current users profile under C:\Users\\AppData\Local and can be hidden. You can still navigate to it by typing %localappdata% in Windows Explorer, or in the search field on the Windows Start Menu.

#### Changing the predefined input and output sizes

If another input or output size than the predefined is used, it is recommended to edit the values in the EDS file to match the new system parameter values.

Continues on next page

## 3 Software overview

---

### 3.1 Information about the internal slave device

Continued

An example from the EDS file where the predefined input and output sizes are changed from 8 bytes to 16 bytes is shown below:

```
[IO_Info]
  Default = 0x0000;
  Input1 =   16;
  Output1 =   16;
```

---

#### I/O connection

The internal slave device supports both Polled and Change-of-State (COS) connection. Size and connection type supported are defined in parameter DeviceNet Internal Device, see Type DeviceNet Internal Device on page 111.



#### Note

When using Polled Connection on a DeviceNet device, the output signals of the device will be updated directly.



#### Note

If the DeviceNet internal slave device loses connection with the master, for example if the connection is interrupted, the input signals of the slave device are cleared (reset to zero).

---

#### Limitations

The DeviceNet internal slave device has the following limitations:

- ? The predefined internal slave device DN\_Internal\_Device is supporting a polled connection with the size of 8 digital input bytes and 8 digital output bytes but can be increased to the maximum value, which is 64 digital input bytes and 64 digital output bytes.
- ? Both the input and output map starts at bit 0 and ends at bit 63.

---

## 3.2 Information about the internal master

---

### General

To be able to use the DeviceNet internal master, the IRC5 controller must be installed with the option 709-1 DeviceNet Master/Slave .

The DeviceNet internal master can for example be used to:

- ? connect DeviceNet I/O devices to the IRC5 controller.
- ? connect the IRC5 controller to another IRC5 controller which acts as a slave.

---

### Predefined Network

When the robot system is installed with the DeviceNet Master/Slave option, a predefined industrial network with the name DeviceNet is created at system startup.

---

### Device Templates

There is a set of predefined device templates available for the internal master. These device templates can be used when defining a new device by using the Configuration Editor in RobotStudio or FlexPendant, see Internal master configuration on page 38. Examples of present device templates are:

- ? ABB DeviceNet Slave Device is used on the master side to connect to an IRC5 DeviceNet slave using the DeviceNet PCI Express board.
- ? ABB DeviceNet Anybus Slave Device is used on the master side to connect to an IRC5 DeviceNet slave using the DeviceNet Anybus Slave.
- ? DeviceNet Generic Device is used on the master side to connect to an I/O device when the EDS file is unavailable, using Change Of State connection.

### Generic Device template

Use the DeviceNet Generic Device template if the EDS file is unavailable. Using this template, you only need to know the network address of the I/O device to be able to communicate with it.

When the I/O device is connected, event messages containing the information necessary to configure the device, will appear on the Event Log window of the FlexPendant. The following information appears:

- ? Device identification system parameters (Vendor ID, Device Type and Product Code)
- ? The connection system parameters of the device (Connection Type, Connection Input Size and Connection Output Size)

Other system parameters for the device can be left to their default values.

Continues on next page

## 3 Software overview

---

### 3.2 Information about the internal master

Continued

For more information see Configuration of third party devices on page 43.



#### Note

The DeviceNet Generic Device template should only be used when installing and commissioning new I/O devices because it will increase the startup time. When restarting the system, the identification of the I/O device will be lost and there will not be any information if the I/O device is replaced with another I/O device, which has other functionality or size.

#### Template I/O configuration files

Template I/O configuration files are available for the DeviceNet I/O devices from ABB Robotics. These files contain a predefined I/O device with I/O signals for all available inputs and outputs. The files can be loaded to the controller, using RobotStudio or the FlexPendant, to facilitate and speed up the configuration.

The template configuration files can be obtained from the PC or the IRC5 controller.

? On the PC where the RobotWare is installed : %LocalAppData%\ABB Industrial IT\Robotics

? On the IRC5 Controller :



#### Note

%LocalAppData% is located in the current users profile under C:\Users\\AppData\Local and can be hidden. You can still navigate to it by typing %localappdata% in Windows Explorer, or in the search field on the Windows Start Menu.

For more information about the DeviceNet devices from ABB Robotics, see Boards and devices on page 47.

---

#### Number of allowed I/O devices

A maximum number of 20 user defined I/O devices can be defined on the DeviceNet industrial network in the IRC5 system, for more information see Device Type of I/O System section in Technical reference manual - System parameters, see References on page 7. DeviceNet has an addressing range from 0-63.

The following are counted as user defined I/O devices:

- ? All DeviceNet slave I/O devices connected to the IRC5 DeviceNet master.
- ? Simulated DeviceNet I/O devices.



#### Note

The internal slave device is not counted as an user defined I/O device.

ABB I/O devices and I/O devices from other vendors can be used. No additional software option, except for the DeviceNet Master/Slave option, is required to run I/O devices from other vendors.



---

## 4 Configuring the internal slave device

### 4.1 Recommended working procedure

---

#### General

The internal slave device is pre-installed at the system startup. However, the input and output size of the device can be changed.

This section describes the recommended working procedure when installing and configuring an internal slave device. The working procedure helps to understand the dependencies between the different steps.

When the IRC5 controller is connected to an external master, the IRC5 controller acts as an ordinary device on the DeviceNet network.



#### Note

It is only possible to have one internal slave device.

---

#### Basic steps

Use this procedure to install and configure a DeviceNet slave.

Action	See
Configure the internal slave device in the IRC5 controller using RobotStudio or the FlexPendant.	Configuring the internal slave device on page 34



## 4 Configuring the internal slave device

### 4.2 Configuring the internal slave device

### 4.2 Configuring the internal slave device

#### Internal slave configuration

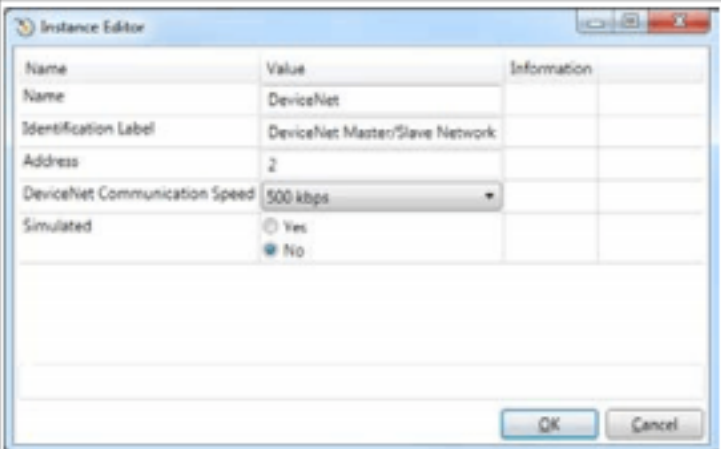
Use this procedure to configure the internal slave device in the IRC5 controller, using RobotStudio.

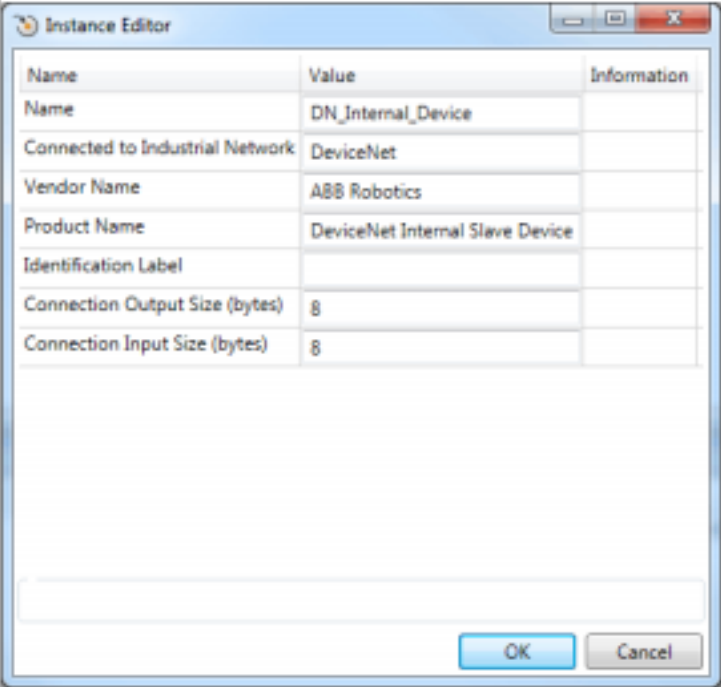
	Action	Note
1	Start RobotStudio and connect to the IRC5 controller. Request write access.	
2	Open the Configuration Editor and select I/O System .	For more information about the parameters, see System parameters on page 97.
3	In the Type list, click Industrial Network , right-click in the workspace on the DeviceNet item and select Edit Industrial Network .	
4	<p>If needed, change the DeviceNet address on the IRC5 DeviceNet master and internal slave device.</p> <p>? Address , set the address of the DeviceNet master and internal slave device.</p> <p>Click OK .</p>	 <p>xx1400001531</p>
	 Note	<p>Note that the network settings are shared between the internal slave device and the internal master if the IRC5 controller acts as both on the DeviceNet network.</p>
5	<p>In the Type list, click DeviceNet Internal Device , right-click in the workspace and select DN_Internal_Device .</p> <p>Change the default values for Connection Input Size and Connection Output Size to the desired size.</p> <p>Click OK .</p>	 <p>xx1400001532</p>

Continues on next page

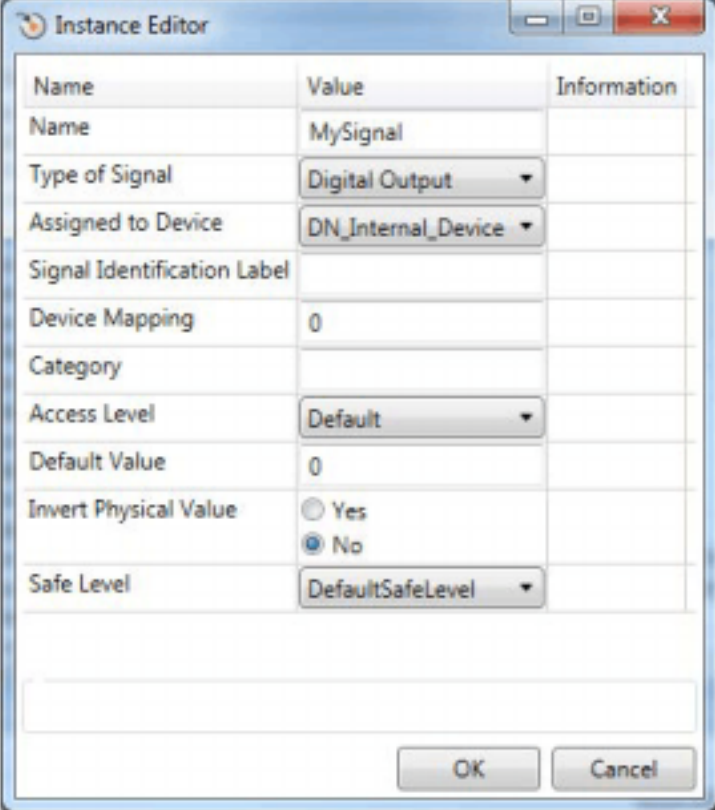
	Action	Note
6	In the Type list, click Signal . Add I/O signals for the internal slave device, DN_Internal_Device .	 <p>xx1400001533</p>
7	Restart the controller. Now the IRC5 controller is ready to be contacted from another DeviceNet master.	



Note

For the DeviceNet internal slave device, both the input and output map starts at bit 0 and ends at bit 63.

## 4 Configuring the internal slave device

---

### 4.3 Configuring the external master

### 4.3 Configuring the external master

---

#### General

The external master is configured using the vendor specific configuration tool that is delivered, or bought, together with the master.

The tool is used in order to specify all the devices in the DeviceNet network. One of the devices is the internal slave device of the IRC5 controller. To be able to create such a device, the EDS file describing the internal slave device has to be imported into the vendor specific configuration tool, see EDS file on page 29.

All other I/O devices used in the network also has to have its EDS file imported.

---

#### External master configuration

This procedure describes the general steps that needs to be performed when configuring an external master, independent of which tool is used.

	Action
1	Use the external master configuration tool to: <ul style="list-style-type: none"><li>? Specify the address of the external DeviceNet master.</li><li>? Import the EDS files for the internal slave device and all other types of I/O devices in the network.</li><li>? Add the IRC5 controller I/O device and set the same DeviceNet address as in the IRC5 controller.</li><li>? Add any other I/O devices into the network structure.</li><li>? Add signals for all I/O devices including the IRC5 controller I/O device.</li></ul>

## 5 Configuring the internal master

### 5.1 Recommended working procedure

#### General

This section describes the recommended working procedure when installing and configuring a DeviceNet internal master. The working procedure helps to understand the dependencies between the different steps.

#### Basic steps

Use this procedure to install and configure a DeviceNet master.

	Action	See
1	Configure the master in the IRC5 controller using RobotStudio or the Flex-Pendant.	Configuring the IRC5 controller on page 38
2	Manual configuration of I/O devices in RobotStudio	Manual configuration of I/O devices in RobotStudio on page 39
3	Manual configuration of I/O devices after a network scan	Manual configuration of I/O devices after a network scan on page 41
4	Automatic configuration of I/O devices	Automatic configuration of I/O devices on page 42
5	Configuring third party devices.	Configuration of third party devices on page 43.

#### Additional configuration

Action	See
Setting up communication between two IRC5 controllers.	Communication between two IRC5 controllers on page 45.

## 5 Configuring the internal master

### 5.2 Configuring the IRC5 controller

### 5.2 Configuring the IRC5 controller

#### Internal master configuration

Use this procedure to configure the master in the IRC5 controller, using the Configuration Editor in RobotStudio.

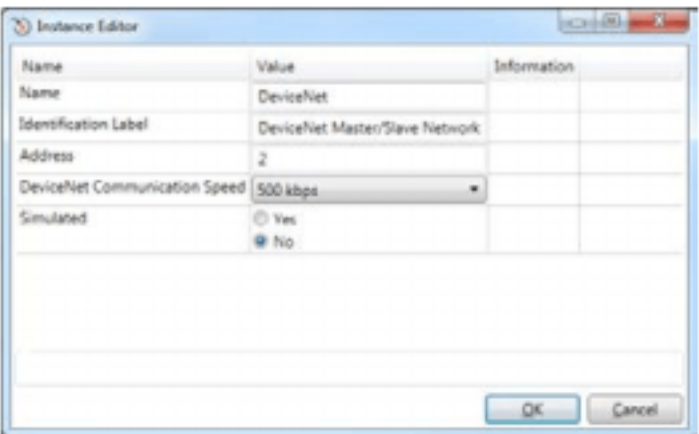
	Action	Note
1	Start RobotStudio and connect to the IRC5 controller. Request write access.	
2	Click Configuration Editor and select I/O System .	For more information about the parameters, see System parameters on page 97.
3	In the Type list, click Industrial Network and then right-click in the workspace on the DeviceNet and select Edit Industrial Network .	
4	<p>If needed, change the parameter values for the network.</p> <p>? Address , set the address of the DeviceNet master.</p> <p>Click OK .</p> <p> <b>Note</b></p> <p>Note that the network settings are shared between the internal slave device and the internal master if the IRC5 controller acts as both on the DeviceNet network.</p>	 <p>xx1400001531</p>
5	Add I/O devices to the DeviceNet master.	See step 2 of Manual configuration of I/O devices in RobotStudio on page 39.

Continues on next page

5.2.1 Manual configuration of I/O devices in RobotStudio

Procedure

Use this procedure to configure the I/O devices in RobotStudio.

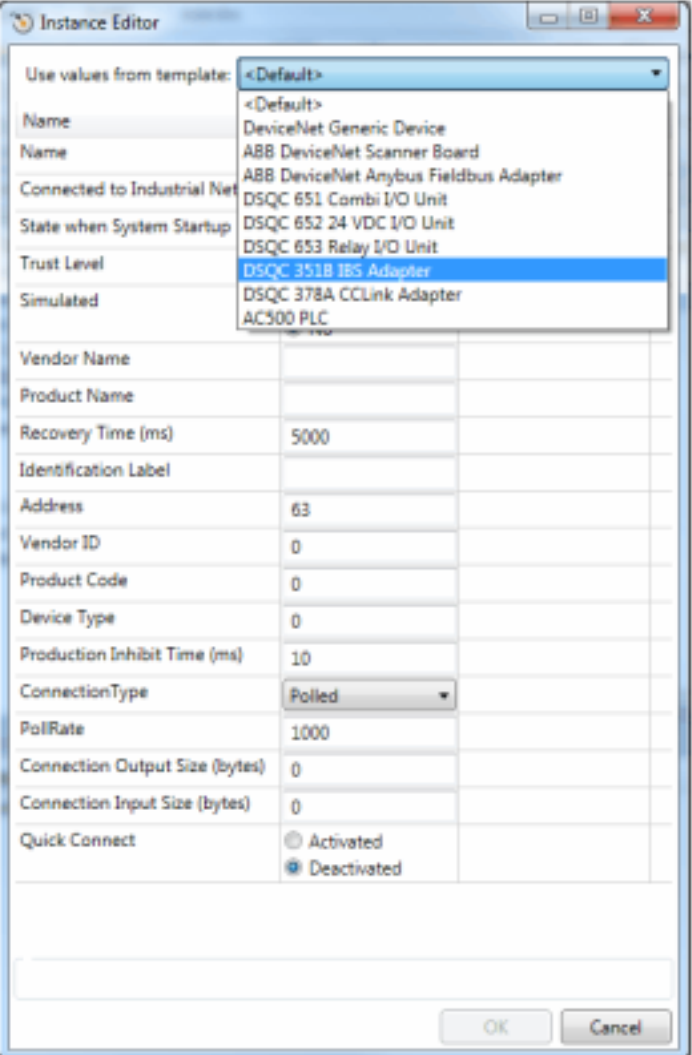
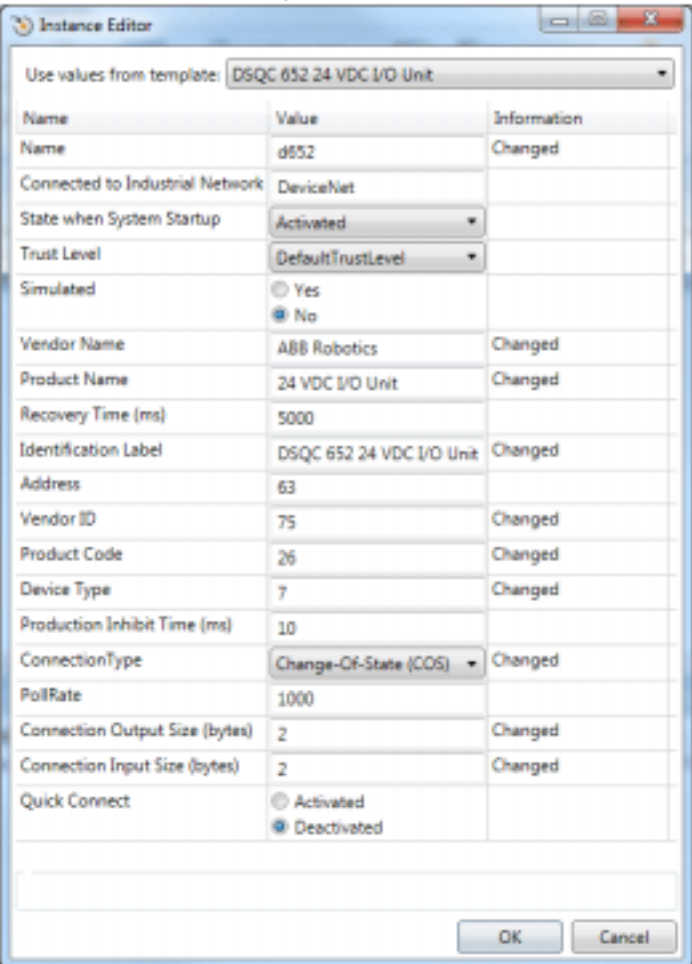
	Action	Note
1	Start RobotStudio and connect to the IRC5 controller. Request write access.	
2	If required, change the address of the DeviceNet network.	See step 3 of Internal master configuration on page 38.
3	<p>In the Type list, click DeviceNet Device then right-click in the workspace and select New DeviceNet Device .</p> <p>? Select a predefined device template or enter the parameter values to configure the device.</p>	 <p>xx1400001541</p>
4	<p>Enter the parameter values for the device.</p> <p>? Name , user defined.</p> <p>? Connected to Industrial Network , shall be DeviceNet .</p> <p>? Address , the address of the device.</p> <p>? Other parameters as well can be changed if applicable.</p> <p>Click OK .</p>	<p>DSQC 652 example:</p>  <p>xx1400001542</p>

Continues on next page

## 5 Configuring the internal master

### 5.2.1 Manual configuration of I/O devices in RobotStudio

Continued

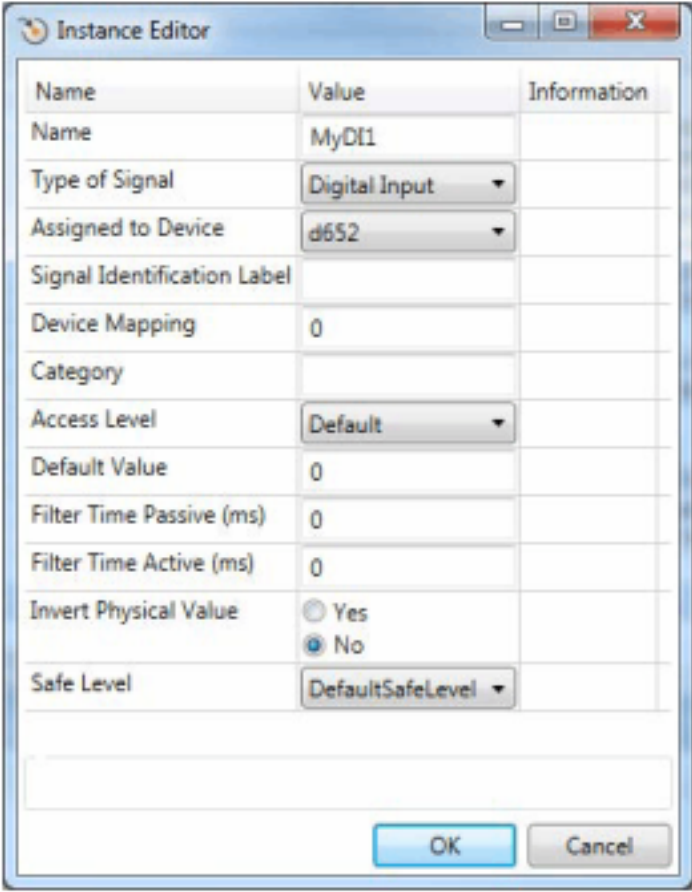
	Action	Note
5	In the type list, click Signal .	
6	<p>Add I/O signals to the devices</p> <ul style="list-style-type: none"> <li>? Name , user defined.</li> <li>? Type of Signal , select signal type from the drop-down list.</li> <li>? Assigned to Device , select from the list of previously defined devices.</li> <li>? Device Mapping , specifies which bit the signal uses in the I/O memory of the I/O device.</li> </ul> <p>Click OK .</p>	 <p>xx1400001543</p>
7	Restart the IRC5 controller.	



## 5.2.2 Manual configuration of I/O devices after a network scan

## Procedure

Use this procedure to configure the I/O devices by using network scan.

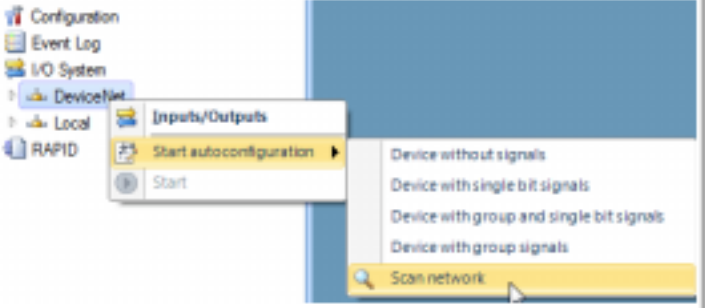
	Action	Note
1	Start RobotStudio and connect to the IRC5 controller. Request write access. To proceed with the steps, system should be in manual mode.	
2	Connect the I/O devices physically to the DeviceNet network that needs to be configured.	
3	Change the address of the DeviceNet master, if necessary.	 Note See step 3 of Internal master configuration on page 38.
4	Click I/O System to expand the folder. Select DeviceNet and right-click in the workspace and navigate the shortcut menu to select Scan network ? Information event messages are generated for the I/O device that is discovered on the network.	 xx1400002203
5	For each I/O device that the scan operation discovered, which should be configured in the IRC5 system.	See Manual configuration of I/O devices in RobotStudio on page 39.

## 5 Configuring the internal master

### 5.2.3 Automatic configuration of I/O devices

### 5.2.3 Automatic configuration of I/O devices

#### Procedure

Use this procedure to configure the I/O devices by using Auto Configuration.

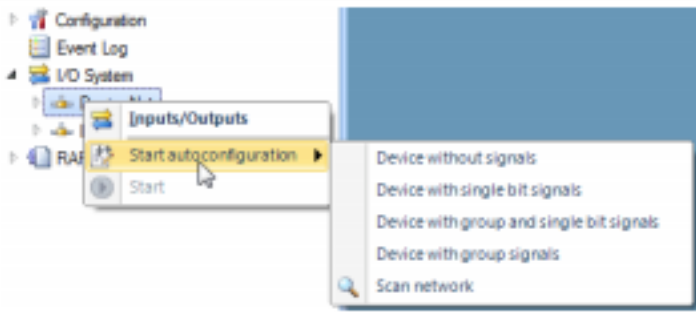
	Action	Note
1	<p>Start RobotStudio and connect to the IRC5 controller. Request write access.</p> <p>To proceed with the steps, system should be in manual mode.</p>	
2	<p>Connect the I/O devices physically to the DeviceNet network that needs to be configured.</p> <p> <b>Note</b></p> <p>The I/O devices found on the network that are not configured in the IRC5 controller or occupied by another master will be configured. If the I/O device requires additional configuration through DeviceNet Command, this must be added manually.</p>	<p>See step 3 of Internal master configuration on page 38.</p>
3	<p>Click I/O System to expand the folder. Select DeviceNet and right-click in the workspace and point to Start autoconfiguration to select the required option.</p> <p>Auto configuration options are:</p> <ul style="list-style-type: none"> <li>? Device without signals</li> <li>? Device with single bit signals</li> <li>? Device with group and single bit signals</li> <li>? Device with group signals</li> </ul>	 <p>xx1400002204</p>
4	<p>Information event messages are generated for each new I/O device found and configured.</p>	
5	<p>If needed, change the parameters for the included I/O devices and remap or change the signals added on the I/O device to reflect the meaning of the data bits.</p>	<p>See step 4 of Manual configuration of I/O devices in RobotStudio on page 39.</p>

## 5.2.4 Configuration of third party devices

### Description of DeviceNet generic device templates

The predefined device template DeviceNet Generic Device can be used to set up a communication with any I/O device in an easy way.

### Usage

When new DeviceNet I/O devices should be configured and the information available is not sufficient to create a new device, then the template DeviceNet Generic Device could be used to retrieve necessary information. This could be the case when third party devices should be configured and the EDS file is missing.



#### Note

When using the template DeviceNet Generic Device, you accept any type of device as long as the address matches - that is, make sure to use the correct address.

### Prerequisites

The network address of the I/O device must be known and the baud rate must match the master.

### Data presented on the FlexPendant

In the Event Log window of the RobotStudio or FlexPendant, you get information about the following system parameters:

- ? Vendor ID
- ? Product Code
- ? Device Type
- ? Connection Type
- ? Connection Input Size
- ? Connection Output Size

### How to use the DeviceNet Generic Device template

The following steps describe how to use the DeviceNet Generic Device template:

	Action	Note
1	Start RobotStudio and connect to the IRC5 controller. Request write access.	
2	Determine the address on the physical I/O device.	

Continues on next page

## 5 Configuring the internal master

### 5.2.4 Configuration of third party devices

Continued

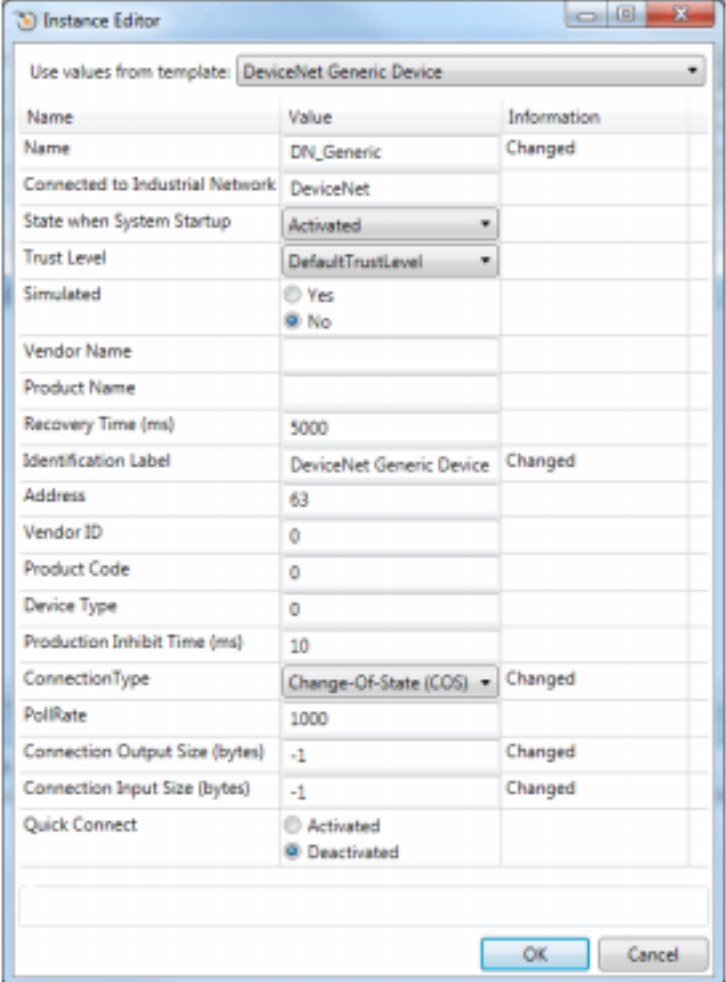
	Action	Note
3	Add new DeviceNet Device and select the DeviceNet Generic Device template from the Use values from template drop-down list.	<p>For information see Operating manual - RobotStudio .</p>  <p>xx1400002213</p>
4	Restart the system.	
5	View event log that shows device identification parameters and connection support information.	<p>For information see Operating manual - RobotStudio and/or Operating manual - IRC5 with FlexPendant .</p> <p>Two event messages appear in the Event Log window in RobotStudio.</p>
6	Create a new I/O device by using information from the event log.	See Manual configuration of I/O devices in RobotStudio on page 39.
7	Define the I/O signals.	See Manual configuration of I/O devices in RobotStudio on page 39.
8	Restart the system.	

5.3 Communication between two IRC5 controllers

Usage

When two IRC5 controllers are connected to each other via DeviceNet, one of them must be configured as a master and the other one must be configured as a slave.



Note

It is also possible to communicate between two IRC5 controllers using a DeviceNet master in one controller, and a DeviceNet anybus slave device in the other controller.

For more information see Application manual - DeviceNet Anybus Slave.

Limitations

The DeviceNet address cannot be the same on the two controllers since they shall be interconnected.



Note

At startup, both controllers will have the same default value for the DeviceNet address. One address needs to be changed.

Illustration

The figure illustrates DeviceNet communication between two IRC5 controllers.

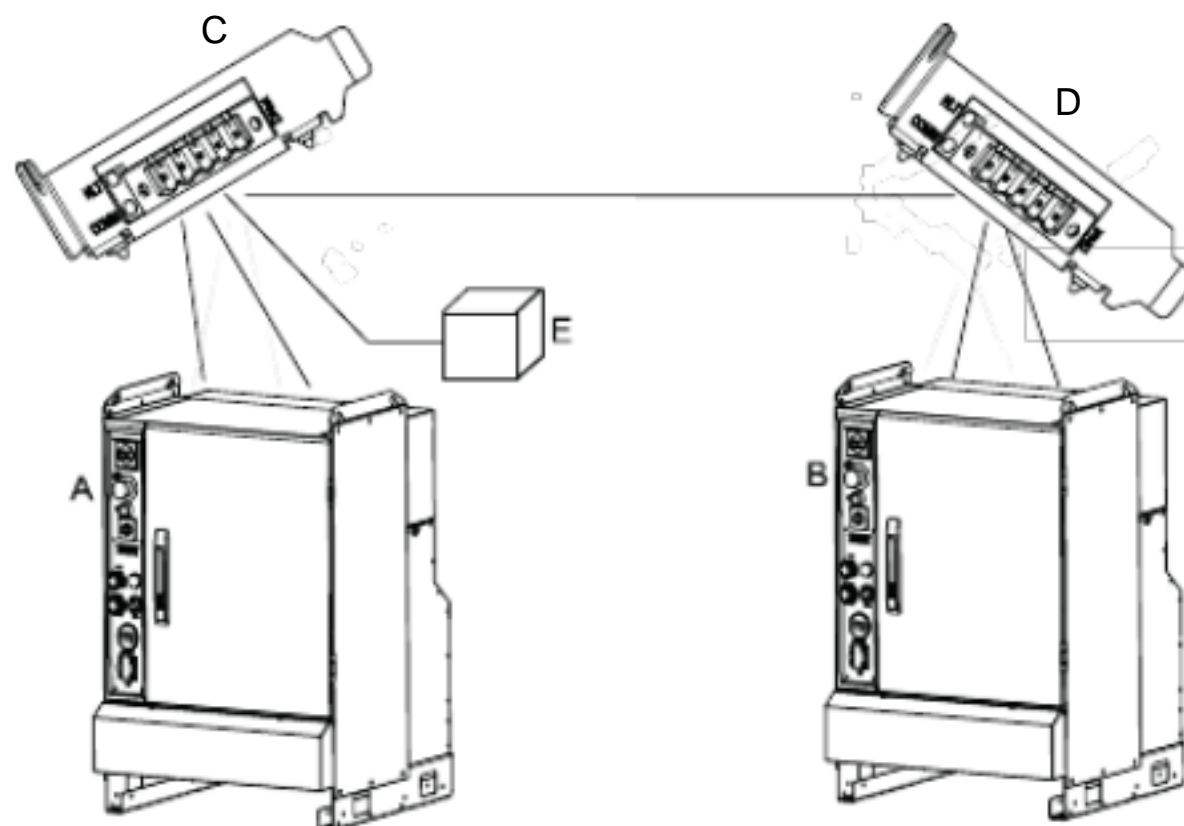

xx1300000700

A	IRC5 DeviceNet master
B	IRC5 DeviceNet slave
C	DeviceNet PCI Express board, DSQC1006, configured as a master using the default address.
D	DeviceNet PCI Express board, DSQC1006, configured as a slave using a different address.

Continues on next page

## 5 Configuring the internal master

### 5.3 Communication between two IRC5 controllers

Continued

E	Power supply unit, 24 VDC
---	---------------------------

#### Configuring the master/slave controllers

The following procedures describe the configuration of a hardware setup like the one illustrated in the picture in section Illustration on page 45.

	Action	Note
1	Configure the IRC5 DeviceNet internal slave device in controller B according to the configuration procedure for the internal slave device. ? Change the DeviceNet address on the IRC5 DeviceNet slave device. ? Use the predefined internal slave device with the name DN_Internal_Device .	Configuring the internal slave device on page 34
2	Configure the IRC5 DeviceNet master in controller A to connect to the IRC5 DeviceNet internal slave device in controller B, according to the configuration procedure for the internal master. ? Use the default value for the DeviceNet address. ? Use the DeviceNet device template DN_Device when adding the slave in the master controller.	Configuring the IRC5 controller on page 38
3	Configure signals on the created devices in both controllers.	 Note Input signals to the DN_Internal_Device in the slave controller, are configured as outputs from the device on the master controller, and vice versa.
4	Physically interconnect the two IRC5 controllers.	Cables and connections on page 21
5	Restart the slave controller.	
6	Restart the master controller.	The master will now connect to the slave controller.
7	Now it is possible to set output signals on one controller. The output signals appear as inputs on the other controller, and vice versa.	

## 6 Boards and devices

### 6.1 General

#### 6.1.1 DeviceNet network and I/O board status LED description

##### General

Each of the devices connected to the DeviceNet network includes LED indicators which indicate the condition of the device and the function of the network communication.

##### LEDs

The LEDs found on the devices connected may be divided into two categories.

##### Common LEDs

The following LEDs can be found on all devices:

- ? MS - Module status
- ? NS - Network status

##### Specific LEDs

Certain devices also include the following LEDs:

- ? DeviceNet Tx - DeviceNet network transmit
- ? DeviceNet Rx - DeviceNet network receive

##### MS - Module status

The bicolor (green/red) LED indicates the status of the device. It indicates whether or not the device has power and is operating properly. The LED is controlled by software. The following table shows the different states of the MS LED.

LED color	Description	Remedy/cause
OFF	No power applied to the device.	Check power supply.
GREEN steady	Device is operating in a normal condition.	If no light, check other LED modes.
GREEN flashing	Device needs commissioning due to missing, incomplete or incorrect configuration. The device may be in the stand-by state.	Check system parameters. Check messages.
RED flashing	Recoverable minor fault.	Check messages.
RED steady	The device has an unrecoverable fault.	Device may need replacing.
RED/GREEN flashing	The device is running self test.	If flashing for more than a few seconds, check hardware.

Continues on next page



## 6 Boards and devices

### 6.1.1 DeviceNet network and I/O board status LED description

Continued

#### NS - Network status

The bicolor (green/red) LED indicates the status of the communication link. The LED is controlled by software. The following table shows the different states of the NS LED.

LED color	Description	Remedy/cause
OFF	Device has no power or is not online. The device has not completed the Dup_MAC_ID test yet.	Check status of MS LED. Check power to affected module.
GREEN steady	The device is online and has connection in the established state. For a group 2 device only: the device is allocated to a master. For a UCMM capable device: the device has one or more established connections.	If no light, check other LED modes.
GREEN flashing	Device is online, but has no connections in the established state. The device has passed the Dup_MAC_ID test, is online, but has no established connections to other nodes. For a group 2 device only: the device is not allocated to a master. For a UCMM capable device: the device has no established connections.	Check that other nodes in the network are operative. Check parameter to see whether module has correct ID.
RED flashing	One or more I/O connections are in the time-out state.	Check system messages.
RED steady	Failed communication device. The device has detected an error rendering it incapable of communicating on the network. (Duplicate MAC_ID, or Bus-off).	Check system messages and parameters.

#### DeviceNet Tx - DeviceNet network transmit

The following table shows the different states of the DeviceNet Tx LED.

LED color	Description	Remedy/cause
GREEN steady	Physically connected to the DeviceNet Tx line.	If no light when transmission is expected, check error messages. Check system boards in rack.
GREEN flashing	Flashes when the device is transmitting data on the DeviceNet network.	

#### DeviceNet Rx - DeviceNet network receive

The following table shows the different states of the DeviceNet Rx LED.

LED color	Description	Remedy/cause
GREEN steady	Physically connected to the DeviceNet Rx line.	If no light, check network and connections.
GREEN flashing	Flashes when the device is receiving data on the DeviceNet network.	



---

## 6.1.2 DeviceNet network status LEDs at power-up

---

### Process

The system performs a test of the MS and NS LEDs during startup. The purpose of this test is to check that all LEDs are working properly. The test runs as follows:

Order	LED action
1	NS LED is switched Off.
2	MS LED is switched On green for approx. 0.25 seconds.
3	MS LED is switched On red for approx. 0.25 seconds.
4	MS LED is switched On green.
5	NS LED is switched On green for approx. 0.25 seconds.
6	NS LED is switched On red for approx. 0.25 seconds.
7	NS LED is switched On green.

---

### Additional LEDs

If a device has other LEDs, each LED is tested in sequence.

## 6 Boards and devices

---

### 6.1.3 External devices

### 6.1.3 External devices

---

#### General

Up to 20 I/O devices can be connected to the same controller.

---

#### Requirements

Description	Data/value	More information
The maximum cable length between controller and external I/O device.	100 m	Selecting cables on page 25.
Controller placement on cable chain.	At one end or anywhere between the ends.	
Power supply to devices.	24 VDC	
Function of devices.		Section Device descriptions on page 54.
Termination of DeviceNet network.	121 ohm resistor	Termination resistors on page 23.

## 6.1.4 Coil neutralization

### External devices

External relay coils, solenoids, and other devices that are connected to the controller must be neutralized. The following sections describe how this can be done.



#### Note

The turn-off time for DC relays increases after neutralization, especially if a diode is connected across the coil. Varistors give shorter turn-off times. Neutralizing the coils lengthens the life of the switches that control them.

### Clamping with a diode

The diode should be dimensioned for the same current as the relay coil, and a voltage of twice the supply voltage.

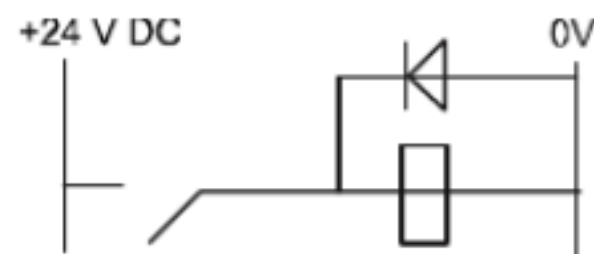

xx0100000163

### Clamping with a varistor

The varistor should be dimensioned for the same current as the relay coil, and a voltage of twice the supply voltage.

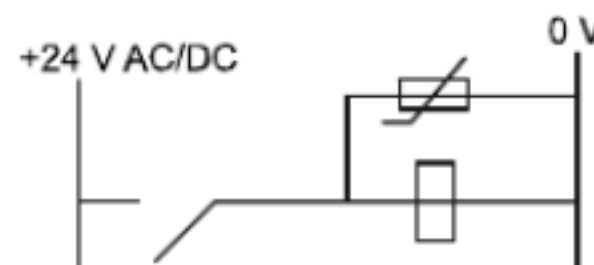

xx0100000164

### Clamping with an RC circuit

R 100 ohm, 1W C 0.1 - 1 mF.

>500 V max. voltage, 125 V nominal voltage.

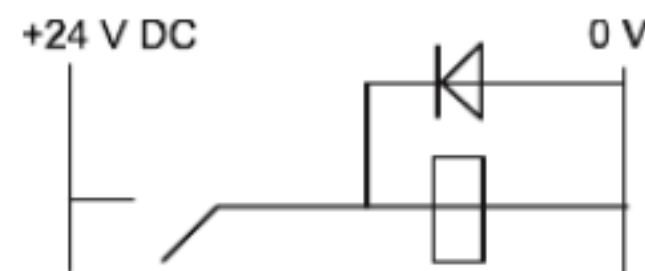

xx0100000165

## 6 Boards and devices

### 6.1.5 Setting DeviceNet network ID

### 6.1.5 Setting DeviceNet network ID

#### Description

Each device is given a unique address (ID).

#### How to set the ID

The connector contains address pins and can be keyed as shown in the following figure. When all terminals are unconnected the highest address 63 is obtained. When all terminals are connected to 0 V, the address would be 0.

To obtain the address 10:	Cut address pins 2 and 8
To obtain the address 25:	Cut address pins 1, 8 and 16

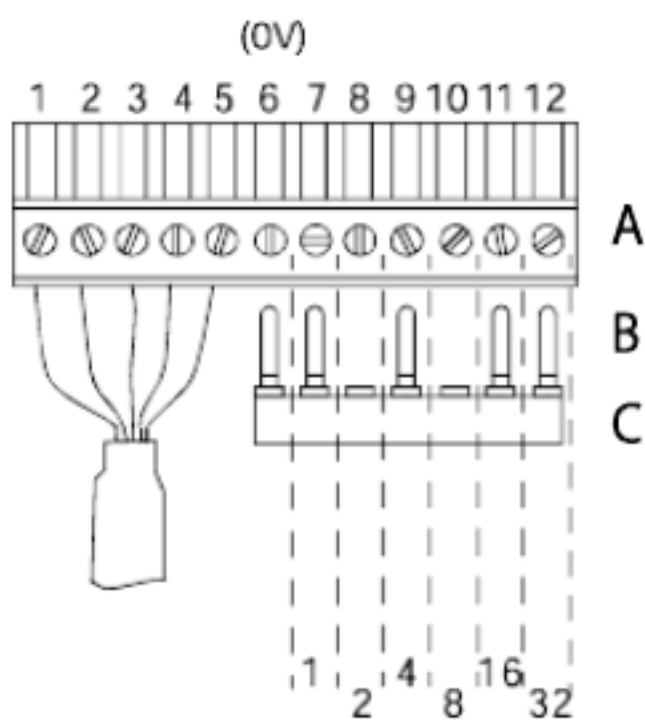

xx0100000245

A	Connector X5
B	Address pins
C	Address key



#### Note

Do not change the address with power on.

#### Connector X5

Connector X5 is a DeviceNet connector. The following table shows the connections to connector X5.

Signal name	X5 pin
1	Supply voltage GND - Black
2	CAN signal low - Blue
3	Shield
4	CAN signal high - White
5	Supply voltage 24 VDC - Red
6	Logic GND
7	Board ID bit 0 (LSB)

Continues on next page

Signal name	X5 pin
8	Board ID bit 1
9	Board ID bit 2
10	Board ID bit 3
11	Board ID bit 4
12	Board ID bit 5 (MSB)

## 6 Boards and devices

---

### 6.2.1 Introduction

## 6.2 Device descriptions

### 6.2.1 Introduction

#### Overview

This section includes descriptions of the different I/O devices that support DeviceNet communication. The following devices are described:

Board designation	Name of device	Type of device	Article number
DSQC 351B	DeviceNet/INTERBUS	Gateway I/O device	3HNE00006-1
DSQC 377B	Queue tracking	Encoder interface I/O device	3HNE01586-1
DSQC 378B	DeviceNet/CCLink	Gateway I/O device	3HNE00421-1
DSQC 651	AD combi I/O	Distributed I/O device	3HAC025784-001
DSQC 652	Digital I/O	Distributed I/O device	3HAC025917-001
DSQC 653	Digital I/O with relay outputs	Distributed I/O device	3HAC025918-001

There are template I/O configuration files available for the above devices. For more information, see Template I/O configuration files on page 32.

## 6.2.2 DSQC 351B, DeviceNet/INTERBUS gateway

## Description

The DSQC 351 is a circuit board normally mounted in the control module. As an option, it may also be mounted in an external I/O device.

The device handle input and output signals between the DeviceNet system and the INTERBUS system.

## Communication concept

The INTERBUS system is able to communicate with a number of external devices, depending on the number of process words occupied by each device. The robot controller may be equipped with several DSQC 351 boards. The INTERBUS inputs and outputs are accessible in the robot controller as general inputs and outputs.

The following figure is an outline diagram of the communication concept:

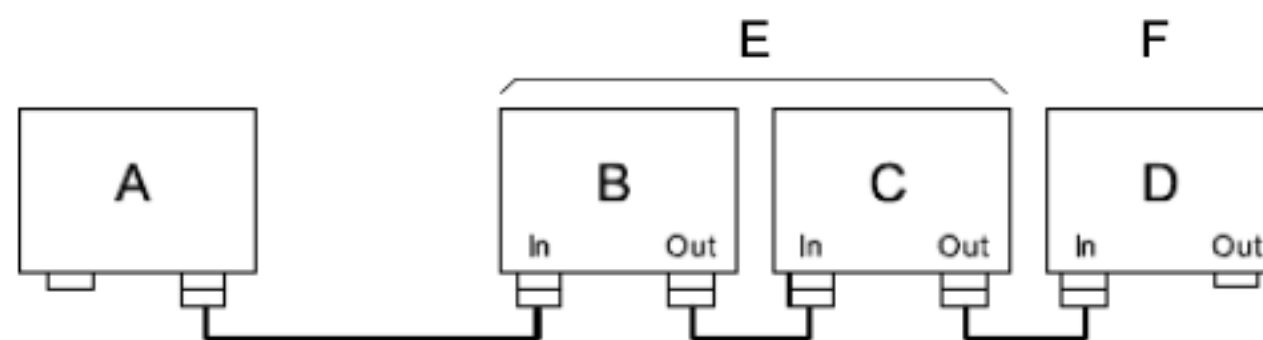

xx0100000224

A	Master PLC (customer equipment)
B	Robot 1 controller, word 1-4
C	Robot 2 controller, word 5-8
D	Robot 3 controller, word 9-12
E	128 inputs/128 outputs
F	64 inputs/64 outputs



## Note

A link is connected between pin 5 and 9 in the plug on the interconnection cable connected to the OUT connector (connector X21) of each device. The link informs the INTERBUS device that more devices are connected further out in the chain. (The last device does not have a cable connected and therefore no link.)

Continues on next page

## 6 Boards and devices

### 6.2.2 DSQC 351B, DeviceNet/INTERBUS gateway

Continued

#### Illustration of DSQC 351

The following illustration shows the DSQC 351 board:

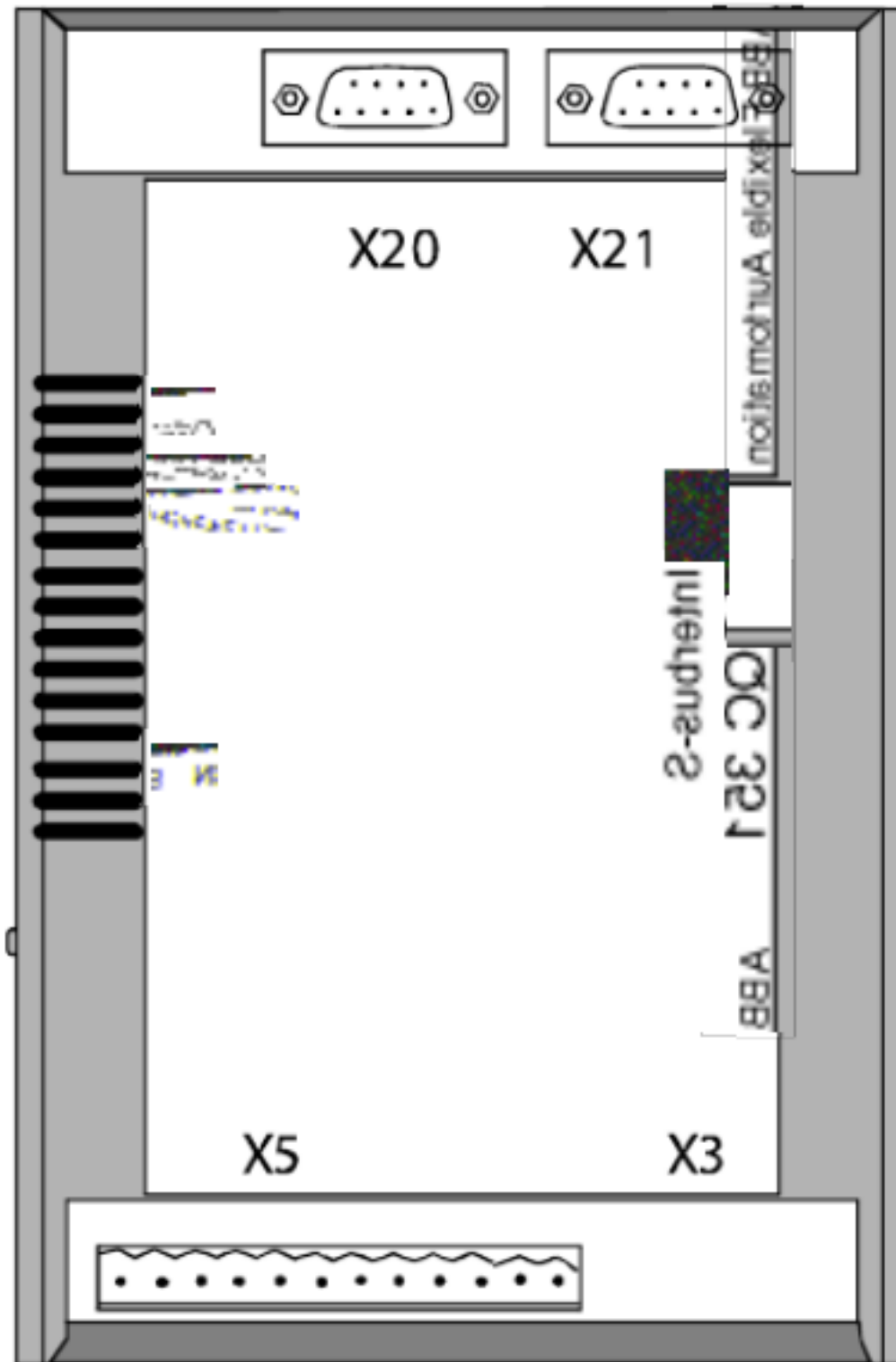

xx0100000225

#### Parts

The table below refers to Illustration of DSQC 351 on page 56.

Item	Description
X3	Back-up feed supply
X5	DeviceNet connector
X20	INTERBUS, input
X21	INTERBUS, output

#### Facts, DSQC 351

This section specifies a number of facts applicable to the DSQC 351. Unless stated otherwise, the data applies to the standard version.

Continues on next page



Also see the INTERBUS specification, International Standard DIN 19258 .

#### Technical data

SW connections	Support for the following connections: ? Polled ? Change-Of-State ? Change-Of-State with acknowledge suppression For descriptions of the different types of I/O connections, see I/O messages - connection types on page 15.
Baud rate	500 Kbps

#### Supply

The INTERBUS gateway must be fed externally to avoid shutting down the INTERBUS net if a robot cell is switched off. The 24V power supply must be fed from an external power source and be connected to connector X3.

#### INTERBUS master setup

The device must be given an ID address, and setup parameters must be entered into the INTERBUS master system.

The device ID to be entered in the INTERBUS master is 3. The length code depends on the selected data. The width is between 1 and 4 configured by the DeviceNet Command, DataWidth .

#### Connector X3

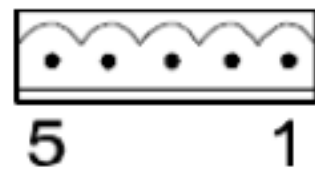

xx0100000221

The following table shows the connections to connector X3:

Signal name	X3 pin	Function
0 VDC	1	Supply voltage GND
NC	2	Not connected
GND	3	Ground connection
NC	4	Not connected
+ 24 VDC	5	Supply voltage + 24 VDC

#### Connector X5

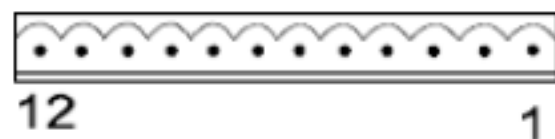

xx0100000244

Connector X5 is a DeviceNet connector specified in section Setting DeviceNet network ID on page 52.

Continues on next page

## 6 Boards and devices

### 6.2.2 DSQC 351B, DeviceNet/INTERBUS gateway

Continued

#### Connector X20

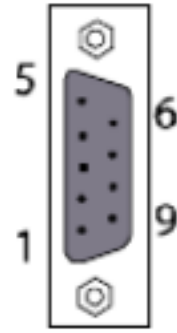

xx0100000220

The table below shows the connections to connector X20:

Signal name	X20 pin	Function
TPDO1	1	Communication line TPDO1
TPDI1	2	Communication line TPDI1
GND	3	Ground connection
NC	4	Not connected
NC	5	Not connected
TPDO1-N	6	Communication line TPDO1-N
TPDI1-N	7	Communication line TPDI1-N
NC	8	Not connected
NC	9	Not connected

#### Connector X21

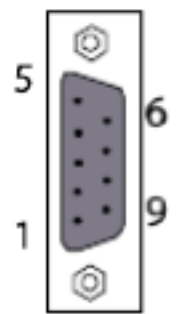

xx0100000220

The following table shows the connections to connector X21:

Signal name	X21 pin	Function
TPDO2	1	Communication line TPDO2
TPDI2	2	Communication line TPDI2
GND	3	Ground connection
NC	4	Not connected
+ 5 V	5	+ 5 VDC
TPDO2-N	6	Communication line TPDO2-N
TPDI2-N	7	Communication line TPDI2-N
NC	8	Not connected
RBST	9	Synchronization

Continues on next page

**Note**

Pin 5 and pin 9 in X21 must be linked together.

## Board specific LEDs

Designation	Color	Description
POWER-24 VDC (upper indicator)	GREEN	Indicates that a supply voltage is present, and has a level above 12 VDC. If there is no light, check that voltage is present on power module. Check also that power is present in power connector. If it is not, check cables and connectors. If power is applied to device but device does not work, replace device.
POWER- 5 VDC (lower indicator)	GREEN	Lit when both 5 VDC supplies are within limits, and no reset is active. If there is no light, check that voltage is present on power module. Check also that power is present in power connector. If it is not, check cables and connectors. If power is applied to device but device does not work, replace device.
RBDA	RED	Lit when this INTERBUS station is last in the INTERBUS network. If it is not, verify the INTERBUS configuration.
BA	GREEN	Lit when INTERBUS is active. If there is no light, check network, nodes and connections.
RC	GREEN	Lit when INTERBUS communication runs without errors. If there is no light, check system messages in robot and in INTERBUS net.

## General LEDs

The significance of the LEDs are specified in section DeviceNet network and I/O board status LED description on page 47.

## Input map

The figure below shows the digital input mapping.

Input byte	Bit								Bit range
	7	6	5	4	3	2	1	0	
0	DI 8	DI 7	DI 6	DI 5	DI 4	DI 3	DI 2	DI 1	0-7
1	DI 16	DI 15	DI 14	DI 13	DI 12	DI 11	DI 10	DI 9	8-15
⋮	⋮	⋮	⋮	⋮	⋮	⋮	⋮	⋮	Depends on DataWidth
(m*2)-1	DI (m*16)	DI (m*16)-1	DI (m*16)-2	DI (m*16)-3	DI (m*16)-4	DI (m*16)-5	DI (m*16)-6	DI (m*16)-7	Depends on DataWidth
(m*2)	Interbus Status	N.U.	N.U.	N.U.	N.U.	N.U.	N.U.	N.U.	Depends on DataWidth

en040000799

m	The number of words (16 bit) that the device has been configured to, using the DeviceNet Command DataWidth .
---	--

Continues on next page

## 6 Boards and devices

### 6.2.2 DSQC 351B, DeviceNet/INTERBUS gateway

Continued

INTER-BUS Status	The status of the INTERBUS communication can be monitored using the signal INTERBUS Status. When INTERBUS Status is set it indicates that the device is in data communication with the PLC/master controlling it, i.e. network is active (the BA LED is lit).
N.U.	Not used. The signal position is reserved for future use and shall not be used.

The INTERBUS Status signal is located in the last bit of the last byte of the input area. For example, if the DataWidth is set to 4 (words) there are 8 bytes of input data (bit 0-63), and the INTERBUS Status is located in the last bit of the 9th byte i.e. bit 71.

#### Output map

The figure below shows the digital output mapping.

Output byte	Bit								Bit range
	7	6	5	4	3	2	1	0	
0	DO 8	DO 7	DO 6	DO 5	DO 4	DO 3	DO 2	DO 1	0-7
1	DO 16	DO 15	DO 14	DO 13	DO 12	DO 11	DO 10	DO 9	8-15
⋮	⋮	⋮	⋮	⋮	⋮	⋮	⋮	⋮	Depends on DataWidth
(m*2)-1	DO (m*16)	DO (m*16)-1	DO (m*16)-2	DO (m*16)-3	DO (m*16)-4	DO (m*16)-5	DO (m*16)-6	DO (m*16)-7	Depends on DataWidth

en040000800

m	The number of words (16 bit) that the device has been configured to, using the DeviceNet Command DataWidth.
---	---

#### DeviceNet Command

Following table gives necessary data on the DeviceNet Command for DeviceNet communication.

DeviceNet Command	Path (DeviceNet parameter)	Allowed values	Usage
DataWidth	6, 20 65 24 01 30 01, C6, 1	0-3 according to: 0 = 1 word (16 DO, 16+1 DI) 1 = 2 words (32 DO, 32+1 DI) 2 = 3 words (48 DO, 48+1 DI) 3 = 4 words (64 DO, 64+1 DI)	Determines the size of the input and output data areas of the INTERBUS gateway.
Reset	4, 20 01 24 01, C1, 1	0	Stores the parameter value in the flash memory and restarts the gateway module with the new parameter values.

Continues on next page

## Additional information

The data areas of the gateway are "byte-consistent", which means that signals within the same byte (groups of 8 bits) are handled as one piece and are guaranteed to belong to the same network-cycle. Normally this does not cause any problems, but if a group signal has been defined across the byte boundaries as e.g. a 16 bit group signal this needs to be considered. It is important to make sure that undesired behaviors are avoided in the case when the group signal is updated at exactly the same time as the gateway is being polled/scanned by one of the masters.

The values for the DeviceNet Command are stored in flash memory of the gateway module. Any change of these values requires a reset (or power cycle) of the gateway module before it actually assumes these new values.



## Note

The DeviceNet Command's DataWidth and Reset, described above, must be defined for the I/O device representing the specific gateway module. See Type DeviceNet Command on page 113 and Template I/O configuration files on page 32.

## 6 Boards and devices

### 6.2.3 DSQC 377B, Queue tracking device

### 6.2.3 DSQC 377B, Queue tracking device

#### Description

The encoder device DSQC 377 provides connection for one encoder and one digital input (synchronization switch), and includes queue tracking functions.

#### Usage

The encoder device is normally used for installation on a conveyor to enable the robot programs to synchronize to the motion (position) of the conveyor (conveyor tracking).

The digital input is used for synchronization switch (also called sync signal), which means conveyor synchronization point.

#### Illustration of DSQC 377

The figure below shows the DSQC 377 board:



xx040000751

Continues on next page

## Parts

Item	Description
X3	Back-up feed supply
X5	DeviceNet connector
X20	Conveyor connection

## Facts, DSQC 377

This section specifies a number of facts applicable to the DSQC 377. Unless stated otherwise, the data applies to the standard version.

## Technical data

No. of encoder inputs	1
No. of digital inputs	1 (24 VDC)
Supply voltage	24 VDC
Supply source	24 V I/O or external supply
SW connections	Support for the polled connection. For descriptions of the different types of I/O connections, see I/O messages - connection types on page 15.
Baud rate	500 Kbps

Also see Product specification - Controller IRC5 .

Continues on next page

## 6 Boards and devices

### 6.2.3 DSQC 377B, Queue tracking device

Continued

#### Encoder connections

The wiring diagram in the figure below shows how to connect the encoder and sync signal switch to the encoder device. As can be seen from the illustration, the encoder is supplied with 24 VDC and 0 V. The encoder has two channels. The main device uses quadrature decoding to compute position and direction information.

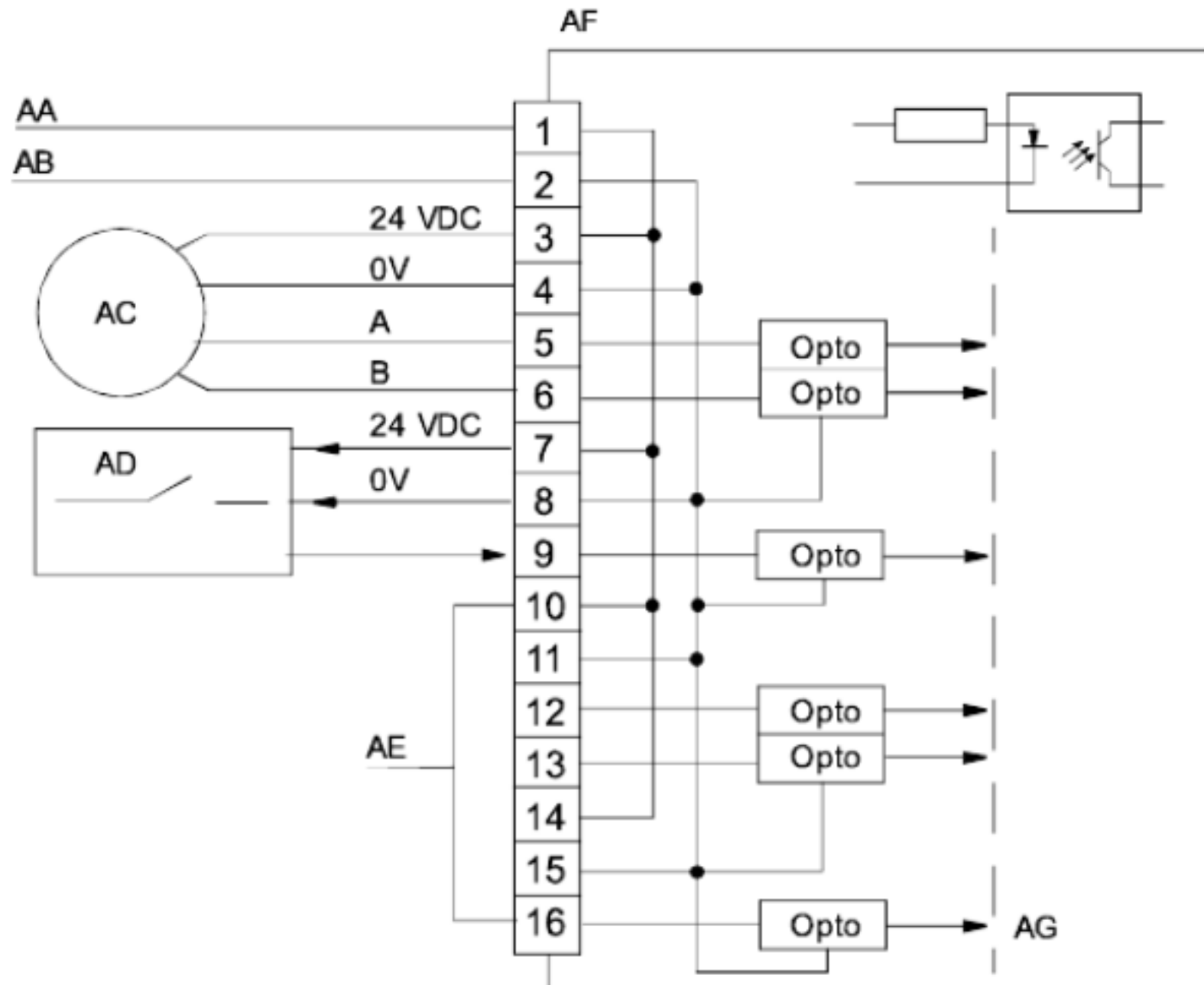

xx0100000234

AA	24 V I/O or external supply
AB	0 V I/O or external supply
AC	Encoder
AD	Sync switch
AE	10-16 not used
AF	Encoder interface device
AG	Galvanic isolation

#### Connector X3

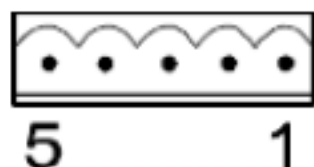

xx0100000221

The table below shows the connections to connector X3:

Signal name	X3 pin	Function
0 VDC	1	Supply voltage GND

Continues on next page



Signal name	X3 pin	Function
NC	2	Not connected
GND	3	Ground connection
NC	4	Not connected
+ 24 VDC	5	Supply voltage + 24 VDC

## Connector X5



xx0100000244

Connector X5 is a DeviceNet connector specified in section Setting DeviceNet network ID on page 52.

## Connector X20

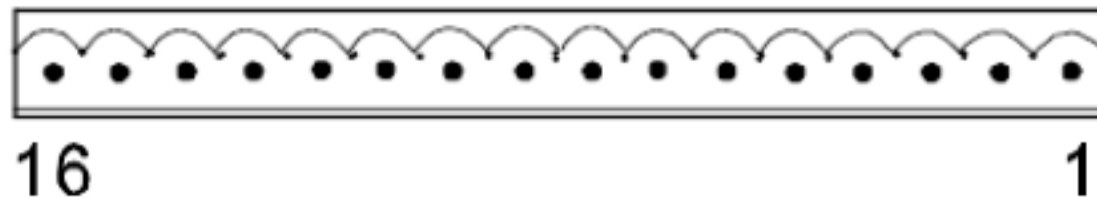

xx0100000235

X20 is the encoder and digital input connector.

The following table shows the connections to connector X20:

Signal name	X20 pin
24 VDC supply	1
0 V	2
Encoder 1 - 24VDC	3
Encoder 1 - 0V	4
Encoder 1 - Phase A	5
Encoder 1 - Phase B	6
Digital input 1 - 24 VDC	7
Digital input 1 - 0 V	8
Digital input 1 - Signal	9
Not used	10
Not used	11
Not used	12
Not used	13
Not used	14
Not used	15
Not used	16

Continues on next page

## 6 Boards and devices

### 6.2.3 DSQC 377B, Queue tracking device

Continued

#### Board specific LEDs

The following table shows the significance of the LEDs on the board.

Designation	Color	Description
POWER, 24 VDC	Green	Indicates that a supply voltage is present, and has a level above 12 VDC. If there is no light, check that voltage is present on power device and in connector X20. If not, check cables and connectors. If power is applied to the device but it does not work, replace the device.
NS/MS	Green/red	Network and module status LEDs. See section DeviceNet network and I/O board status LED description on page 47.
CAN Tx/CAN Rx	Green/red	See section DeviceNet network and I/O board status LED description on page 47.
ENC 1A/1B	Green	Indicates phase 1 and 2 from encoder. Flashes at each Encoder pulse. At frequencies higher than a few Hz, flashing can no longer be observed (light will appear weaker). If there is no light, there is an error due to one or more of the following reasons: <ul style="list-style-type: none"> <li>? Faulty power supply for input circuit (internal or external).</li> <li>? Defective input circuit on board.</li> <li>? Short circuit or broken wire in external wiring or connectors.</li> <li>? Internal error in device.</li> </ul> Constant light indicates constant high level on input and vice versa. No light on one LED indicates fault in one encoder phase.
DIGIN1	Green	Lit when digital input is active. The input is used for external start signal/conveyor synchronization point. If there is no light, there is an error due to one or more of the following reasons: <ul style="list-style-type: none"> <li>? Faulty power supply for input circuit (internal or external).</li> <li>? Faulty limit switch, photocell etc.</li> <li>? Short circuit or broken wire in external wiring or connectors.</li> <li>? Defective input circuit on board.</li> </ul>
ENC 2A/2B		Not used.
DIGIN2		Not used.

#### Input map

The following figure shows the input mapping.



#### Note

Pay attention to the order of the bits for the analog signals.

Continues on next page

Input byte	Bit								Bit range
	7	6	5	4	3	2	1	0	
0	Position								0-31
1									
2									
3									
4	Speed								32-63
5									
6									
7									
8	ObjectsInQ								64-71
9	CntFromEnc1								72-87
10									
11	CntFromEnc2								88-103
12									
13	N.U.	EncA Fault	Encoder Selected	NewObj Strobe	Pass Stw	Ready	Null Speed	Connected	104-111
14	N.U.	N.U.	N.U.	N.U.	PowerUp Status	ScaleEnc Pulse	DirOf Travel	Simulating	112-119
15	TimeStamp								120-151
16									
17									
18									

en040000816

**Note**

The signals CntFromEnc1, CntFromEnc2, and ScaleEncPulse are dependent on the signal PosInJobQ (bit 42 in the output map). DSQC 377-mode is obtained by setting the output signal to 1, and DSQC 354-mode is obtained by setting the output signal to 0.

Generally PosInJobQ concerns only the queue tracking mode. All signals on the DSQC 377 are available even in DSQC 354-mode (c1PosInJobQ=0). The only thing c1PosInJobQ disables, is that the object position is not sent to the main controller. The following table specifies the input signals.

Signal name	Type	Bit	Description
Position	AI	0-31	Position in meters of the first object in the queue. Accuracy: 0.1 mm

Continues on next page

## 6 Boards and devices

### 6.2.3 DSQC 377B, Queue tracking device

Continued

Signal name	Type	Bit	Description
Speed	AI	32-63	Speed of the conveyor in m/s. Resolution: 10 $\mu$ m/s
ObjectsInQ	GI	64-71	Number of objects in queue (0-255). Objects that have entered the queue (passed the sync switch) but have not left the queue (have become connected or gone outside the start window).
CntFromEnc1	GI	72-87	Counter value from encoder to controller (Low Word). The bit group is valid for DSQC 377-mode, i.e. when PosInJobQ is set to 1.
CntFromEnc2	GI	88-103	Counter value from encoder to controller (High Word). The bit group is valid for DSQC 377-mode, i.e. when PosInJobQ is set to 1.
Connected	DI	104	Set when an object is being tracked.
NullSpeed	DI	105	Set when the conveyor is stopped.
Ready	DI	106	Internal handshake signal (toggled).
PassStw	DI	107	Set when an object has gone outside the start window or has fallen off the conveyor.
NewObjStrobe	DI	108	New position from the encoder node to enter the job queue. The bit is valid for DSQC 377-mode, i.e. when PosInJobQ is set to 1.
EncSelected	DI	109	Indicates which encoder is active. 0 = EncA (must be 0) The bit is valid for DSQC 377-mode, i.e. when PosInJobQ is set to 1.
EncAFault	DI	110	Encoder A is faulty. The bit is valid for DSQC 377-mode, i.e. when PosInJobQ is set to 1.
N.U.		111	Not used.
Simulating	DI	112	Module is in simulated mode, i.e. Speed and Position are simulated rather than taken from the actual encoder. The bit is valid for DSQC 377-mode, i.e. when PosInJobQ is set to 1.
DirOfTravel	DI	113	Indicates the direction of the conveyor. 0 = Backward 1 = Forward
ScaleEncPulse	DI	114	The encoder pulse scaled down by the factor given by the command ScalingFactor .
PowerUpStatus	DI	115	Indicates how the last shutdown was made. 0 = Abnormal 1 = Normal
N.U.		116-119	Not used.

Continues on next page

Signal name	Type	Bit	Description
TimeStamp	GI	120-151	Holds the time when following signals were last sampled: ? Position ? Speed ? Connected ? NullSpeed

## Output map

The figure below shows the output signals mapping.

Output byte	Bit								Bit range
	7	6	5	4	3	2	1	0	
0	Sim Mode	N.U.	Soft SyncSig	Enc Select	RemAll PObj	Rem1 PObj	DropW Obj	WaitW Obj	0-7
1	MSB CntToEnc1 LSB								8-23
2									
3	MSB CntToEnc2 LSB								24-39
4									
5	N.U.	N.U.	N.U.	N.U.	N.U.	PosIn JobQ	Force Job	CntTo EncStr	43-47

en040000817



## Note

The signals CntToEnc1 , CntToEnc2, and CntToEncStr are dependent on the signal PosInJobQ (bit 42 in the output map). DSQC 377-mode is obtained by setting the signal to 1, and DSQC 354-mode is obtained by setting the signal to 0.

Generally PosInJobQ concerns only the queue tracking mode. All signals on the DSQC 377 are available even in DSQC 354 mode (c1PosInJobQ=0). The only thing c1PosInJobQ disables, is that the object position is not sent to the main controller.

The following table specifies the output signals.

Signal name	Type	Bit	Description
WaitWObj	DO	0	Set when the robot is waiting for an object to enter the start window.
DropWObj	DO	1	Drop and disconnect the currently tracked object. The object is removed from the queue.
Rem1PObj	DO	2	Remove first pending object from the queue. (If an object is connected it is not removed.)
RemAllPObj	DO	3	Remove all pending objects in the queue. (If an object is connected it is not removed.)

Continues on next page

## 6 Boards and devices

### 6.2.3 DSQC 377B, Queue tracking device

Continued

Signal name	Type	Bit	Description
EncSelect	DO	4	Select encoder: 0=EncA (must be 0) 1=EncB, not used
SoftSyncSig	DO	5	Soft sync-signal This signal can be used instead of a physical signal connected to Digital input 1 of the module.
N.U.		6	Not used.
SimMode	DO	7	If set this signal set the module in simulation mode (simulate Position and Speed instead of using the encoder values). The bit is valid for DSQC 377-mode, i.e. when PosInJobQ is set to 1.
CntToEnc1	GO	8-23	Counter value from controller to encoder (Low Word). The bit group is valid for DSQC 377-mode, i.e. when PosInJobQ is set to 1.
CntToEnc2	GO	24-39	Counter value from controller to encoder (High Word). The bit group is valid for DSQC 377-mode, i.e. when PosInJobQ is set to 1.
CntToEncStr	DO	40	Indication to module that the "CntToEncX" signals contain valid values. The bit is valid for DSQC 377-mode, i.e. when PosInJobQ is set to 1.
ForceJob	DO	41	Run this job even if checkpoint fails (always set/reset together with the CntToEncStr signal). The bit is valid for DSQC 377-mode, i.e. when PosInJobQ is set to 1.
PosInJobQ	DO	42	Set if the module shall send encoder values to the controller instead of handling the queue itself. 0=Queue tracking disabled (DSQC 354-mode) 1=Queue tracking enabled
N.U.		43-47	Not used.

#### Additional information

For detailed information on using the DSQC 377 in an application refer to Application manual - Controller software IRC5 .



#### Note

Different application specific parameters for the DSQC 377B device can be set by using DeviceNet Command.

For detailed information refer to Application manual - Conveyor tracking .

## 6.2.4 DSQC 378B, DeviceNet/CCLink gateway

## Description

The DSQC 378 device offer an interface between the CCLink network and the DeviceNet network as used on the robot system. The devices are regarded as intelligent devices by the CCLink PLC.

## Communication concept

The CCLink can communicate with a number of external devices, depending on the number of stations occupied by each device. There is a maximum of 64 stations, each capable of up to 32 I/O points and 8 points word data. The devices are setup to have between 1 and 4 occupied stations each. The CCLink device is connected to the CCLink PLC by a twisted pair cable with shield.

The CCLink inputs and outputs are accessible in the robot controller as general inputs and outputs.

Following figure is an outline diagram of the communication concept:

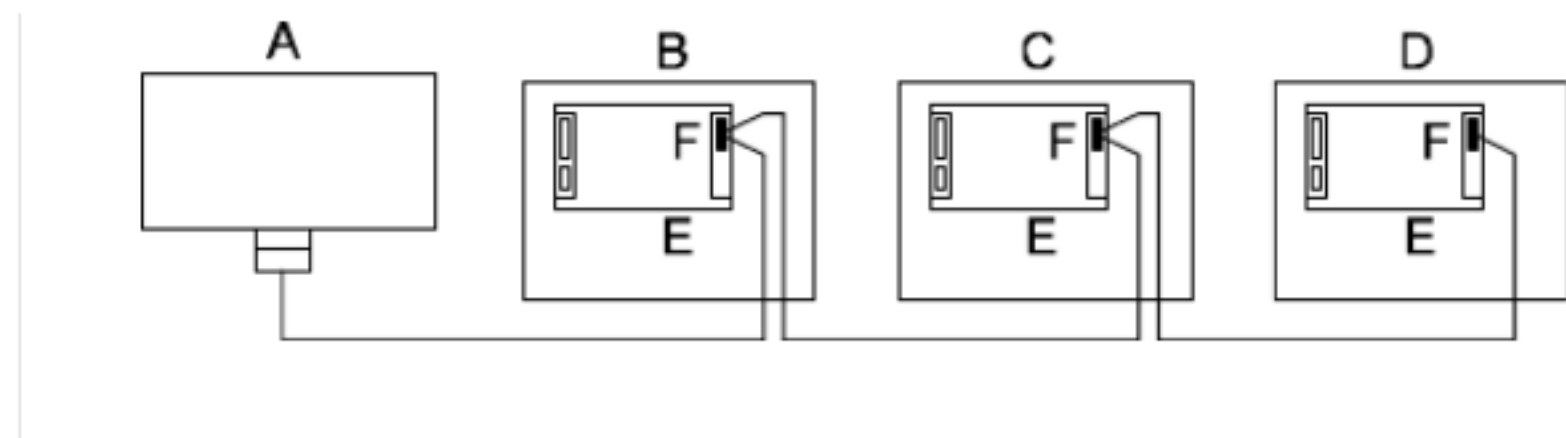

xx0400000826

A	Master PLC (customer equipment)
B	Robot 1 controller
C	Robot 2 controller
D	Robot 3 controller
E	DSQC 378 controller
F	Connector X8 controller



## Note

The CCLink cable must be terminated with termination resistors (110 ohm) in both ends.

Continues on next page



## 6 Boards and devices

### 6.2.4 DSQC 378B, DeviceNet/CCLink gateway

Continued

Illustration of DSQC 378

The following figure shows the DSQC 378 board:

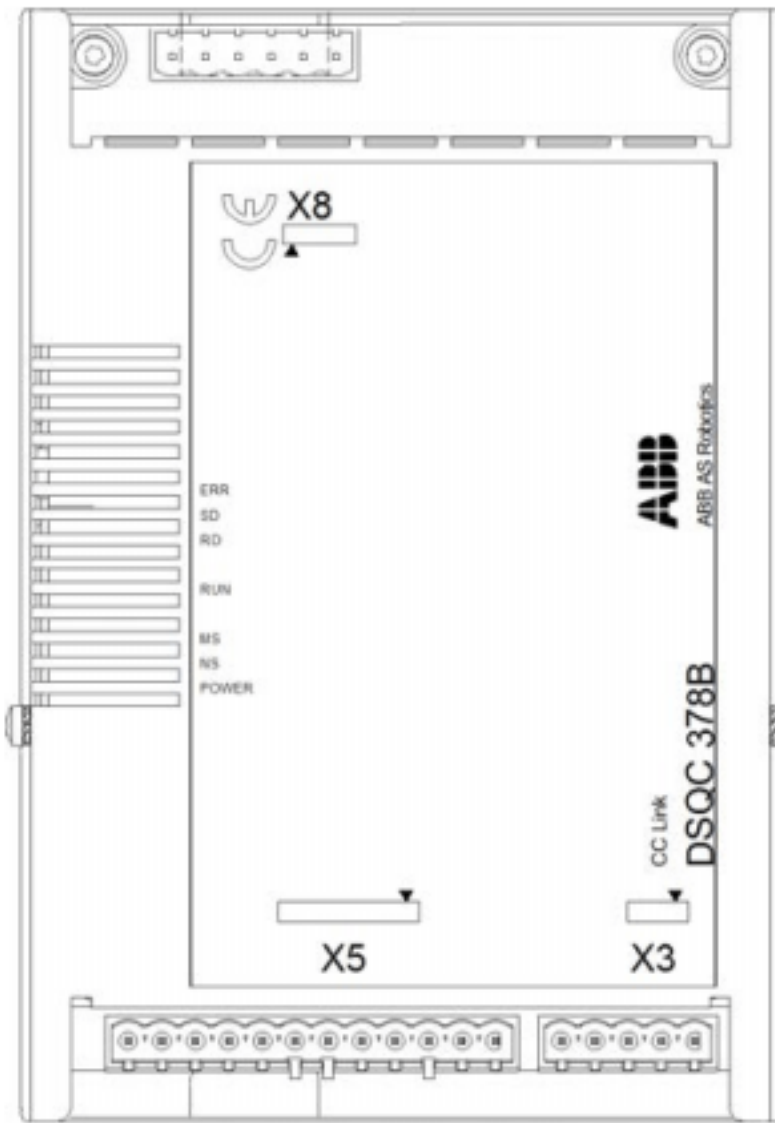

xx1000001343

#### Parts

Item	Description
X3	Back-up feed supply
X5	DeviceNet connector
X8	CCLink network connector

#### Facts, DSQC 378

This section specifies a number of facts applicable to the DSQC 378. Unless stated otherwise, the data applies to the standard version.

#### Technical data

SW connections	Support for the following connections: ? Polled ? Change-Of-State ? Change-Of-State with acknowledge suppression  For descriptions of the different types of I/O connections, see I/O messages - connection types on page 15.
Baud rate	500 Kbps

#### Device setup

The device must be given an ID address, and setup parameters must be entered into the system.

Continues on next page



## Connector X3

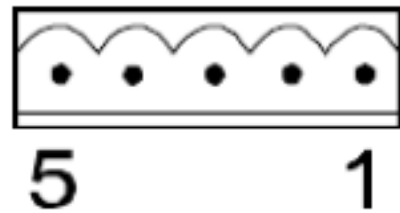

xx0100000221

The table below shows the connections to connector X3:

Signal name	X3 pin	Function
0 VDC	1	Supply voltage GND
NC	2	Not connected
GND	3	Ground connection
NC	4	Not connected
+ 24 VDC	5	Supply voltage +24 VDC

## Connector X5

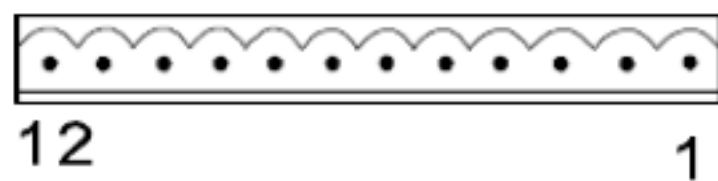

xx0100000244

Connector X5 is a DeviceNet connector specified in section Setting DeviceNet network ID on page 52.

## Connector X8

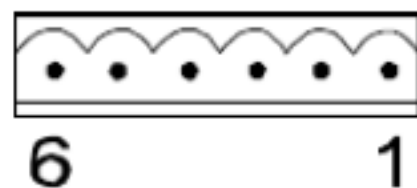

xx0200000265

The table below shows the connections to connector X8:

Signal name	X8 pin	Function
SLD	1	Shield, connected to power GND/Housing
DA	2	Signal line, A
DG	3	Digital GND, connected to signal GND
DB	4	Signal line, B
NC	5	Not connected
FG	6	Power GND, same as SLD

Continues on next page

## 6 Boards and devices

### 6.2.4 DSQC 378B, DeviceNet/CCLink gateway

Continued

#### Board specific LEDs

Designation	Color	Description
POWER-24 VDC	Green	Indicates that a supply voltage is present, and has a level above 12 VDC. If there is no light, check that voltage is present on power module. Check also that power is present in power connector. If it is not, check cables and connectors. If power is applied to device but device does not work, replace device.
RUN (ON: H output)		ON: Receive both refresh and polling signals or just the refresh signal normally, after joining the network. See figure below this table. OFF: <ol style="list-style-type: none"> <li>1 Before joining the network.</li> <li>2 Unable to detect carriers neither for channel 1 or 2.</li> <li>3 Time out.</li> <li>4 Resetting hardware.</li> </ol>
RD		ON: Detecting the carrier for channel 1 or 2. Check cables and terminator. OFF: <ol style="list-style-type: none"> <li>1 Unable to detect carriers neither for channel 1 or 2.</li> <li>2 Resetting hardware.</li> </ol>
SD		ON: During transmission to During transmission + $(0.41 \text{ ms} * 2^{(n-1)})$ n = 1-8 Check setup in both robot controller and PLC. OFF: <ol style="list-style-type: none"> <li>1 Other than listed under ON.</li> <li>2 Resetting hardware.</li> </ol>
ERR		ON: <ol style="list-style-type: none"> <li>1 CRC error. Check setup in both robot controller and PLC.</li> <li>2 Switch setting error during cancellation of reset (0, 65, or greater is set including the number of occupied stations).</li> <li>3 Baud rate switch setting error during cancellation of reset (5 or greater).</li> </ol> OFF: <ol style="list-style-type: none"> <li>1 Normal communication.</li> <li>2 Resetting hardware.</li> </ol> BLINKING: The switch setting has been changed from the setting at the reset cancellation (blinks for 0.4 sec.).

The following figure describes the LED sequences.



#### Note

Read the figure line by line. The Operation column describes the operation status depending on the status of the four LEDs.

Continues on next page



ERRL/ ERR	SDLED/ SD	RDLED/ RD	RUN	Operation
				Communicating normally, but CRC errors have often been detected due to noise.
0.4 sec				The baud rate or station number setting has been changed from the settings at reset cancellation.
				(Impossible operation status.)
				Unable to respond because the received data caused a CRC error.
				(Impossible operation status.)
				Normal communication.
				(Impossible operation status.)
				No data for the host.
				(Impossible operation status.)
				Responds to polling signal, but the refresh reception caused a CRC error.
				(Impossible operation status.)
				Data for the host caused a CRC error.
				(Impossible operation status.)
				(Impossible operation status.)
				(Impossible operation status.)
				Either no data for the host or unable to receive the data for host due to noise.
				Unable to receive due to wire breakage etc. Power off hardware being set.
				Baud rate and/or station number setting error.

en040000827

General LEDs

The significance of the LEDs are specified in section DeviceNet network and I/O board status LED description on page 47.

Continues on next page

## 6 Boards and devices

### 6.2.4 DSQC 378B, DeviceNet/CCLink gateway

Continued

#### Input map

The following figure shows the digital input mapping.

Input byte	Bit								Bit range
	7	6	5	4	3	2	1	0	
0	DI 8	DI 7	DI 6	DI 5	DI 4	DI 3	DI 2	DI 1	0-7
1	DI 16	DI 15	DI 14	DI 13	DI 12	DI 11	DI 10	DI 9	8-15
⋮	⋮	⋮	⋮	⋮	⋮	⋮	⋮	⋮	Depends on OccStat and BasicIO
m-1	DI (m*8)	DI (m*8)-1	DI (m*8)-2	DI (m*8)-3	DI (m*8)-4	DI (m*8)-5	DI (m*8)-6	DI (m*8)-7	Depends on OccStat and BasicIO
m	CCLink Status	N.U.	N.U.	N.U.	N.U.	N.U.	N.U.	N.U.	Depends on OccStat and BasicIO

en040000823

m	The size in bytes (8 bit) that the device has been configured to, using the DeviceNet Commands OccStat and BasicIO . .
CCLink Status	The status of the CCLink communication can be monitored using the signal CCLink Status . When CCLink Status is set it indicates that the CCLink communication is OK.
N.U.	Not used. The signal position is reserved for future use and shall not be used.

The CCLink Status signal is located at the last bit of the last byte of the input area. For example, if OccStat is set to 2 and BasicIO is set to 0 there are 6 bytes of input data (bit 0-47), and the CCLink Status is located in the last bit of the 7th byte i.e. bit 55.

#### Output map

The figure below shows the digital output mapping.

Output byte	Bit								Bit range
	7	6	5	4	3	2	1	0	
0	DO 8	DO 7	DO 6	DO 5	DO 4	DO 3	DO 2	DO 1	0-7
1	DO 16	DO 15	DO 14	DO 13	DO 12	DO 11	DO 10	DO 9	8-15
⋮	⋮	⋮	⋮	⋮	⋮	⋮	⋮	⋮	Depends on OccStat and BasicIO
m-1	DO (m*8)	DO (m*8)-1	DO (m*8)-2	DO (m*8)-3	DO (m*8)-4	DO (m*8)-5	DO (m*8)-6	DO (m*8)-7	Depends on OccStat and BasicIO

en040000824

m	The size in bytes (8 bit) that the device has been configured to, using the DeviceNet Commands OccStat and BasicIO . .
---	--

Continues on next page

## DeviceNet Command

Following table gives necessary data on the DeviceNet Command for DeviceNet communication.

DeviceNet Command	Path (DeviceNet parameter)	Allowed values	Usage
StationNo	6, 20 68 24 01 30 01, C6, 1	1-64	Determines the address of the DSQC 378 on the CCLink connection.
BaudRate	6, 20 68 24 01 30 02, C6, 1	0-4 according to: 0 = 156 kbps 1 = 625 kbps 2 = 2.5 Mbps 3 = 5 Mbps 4 = 10 Mbps	Determines the communication speed on the CCLink bus.
OccStat	6, 20 68 24 01 30 03, C6, 1	1-4 according to: 1 = 1 occupied station 2 = 2 occupied stations 3 = 3 occupied stations 4 = 4 occupied stations	Occupied stations. Determines the size of the input and output data areas of the CCLink module. The size, expressed in bits and bytes, also depends on the value of BasicIO. See table in section Size of input/output data areas on page 77.
BasicIO	6, 20 68 24 01 30 04, C6, 1	0-1 according to: 0 = Bit I/O only 1 = Bit I/O and word I/O	Determines the type of I/O data to be exchanged with the CCLink master. This also affects the size of the input and output data areas of the CCLink module. The size, expressed in bits and bytes, also depends on the value of OccStat. See table in section Size of input/output data areas on page 77.
Reset	4, 20 01 24 01, C1, 1	0	Stores the parameter value in the flash memory and restarts the gateway module with the new parameter values.

## Size of input/output data areas

The size of the input/output data areas expressed in bits and bytes are determined by the values of the DeviceNet Command OccStat and BasicIO according to following table:

Value of OccStat	No. of bits when BasicIO = 0	No. of bytes when BasicIO = 0	No. of bits when BasicIO = 1	No. of bytes when BasicIO = 1
1	16	2	80	10
2	48	6	176	22
3	80	10	272	34
4	112	14	368	46

Continues on next page

Continued

#### Additional information

The data areas of the gateway are "byte-consistent", which means that signals within the same byte (group of 8 bits) are handled as one piece and are guaranteed to belong to the same network-cycle. Normally this does not cause any problems, but if a signal group has been defined across the byte boundaries as e.g. a 16 bit group signal this needs to be considered. It is important to make sure that undesired behaviors are avoided in the case when the group signal is updated at exactly the same time as the gateway is being polled/scanned by one of the masters.

The values for the DeviceNet Command are stored in flash memory of the gateway module. Any change of these values requires a reset (or power cycle) of the gateway module before it actually assumes these new values.



#### Note

The DeviceNet Command's StationNo, BaudRate, OccStat, BasicIO and Reset, described above, must be defined for the I/O device representing the specific gateway module. See Type DeviceNet Command on page 113 and Template I/O configuration files on page 32.

6.2.5 DSQC 651, AD combi I/O

Description

The DSQC 651 is a circuit board normally mounted inside the robot controller. As an option, it may also be mounted in an external I/O module.

The combi I/O device handles digital and analog communication between the robot system and any external systems.

Illustration of DSQC 651

The following figure shows the DSQC 651 device:

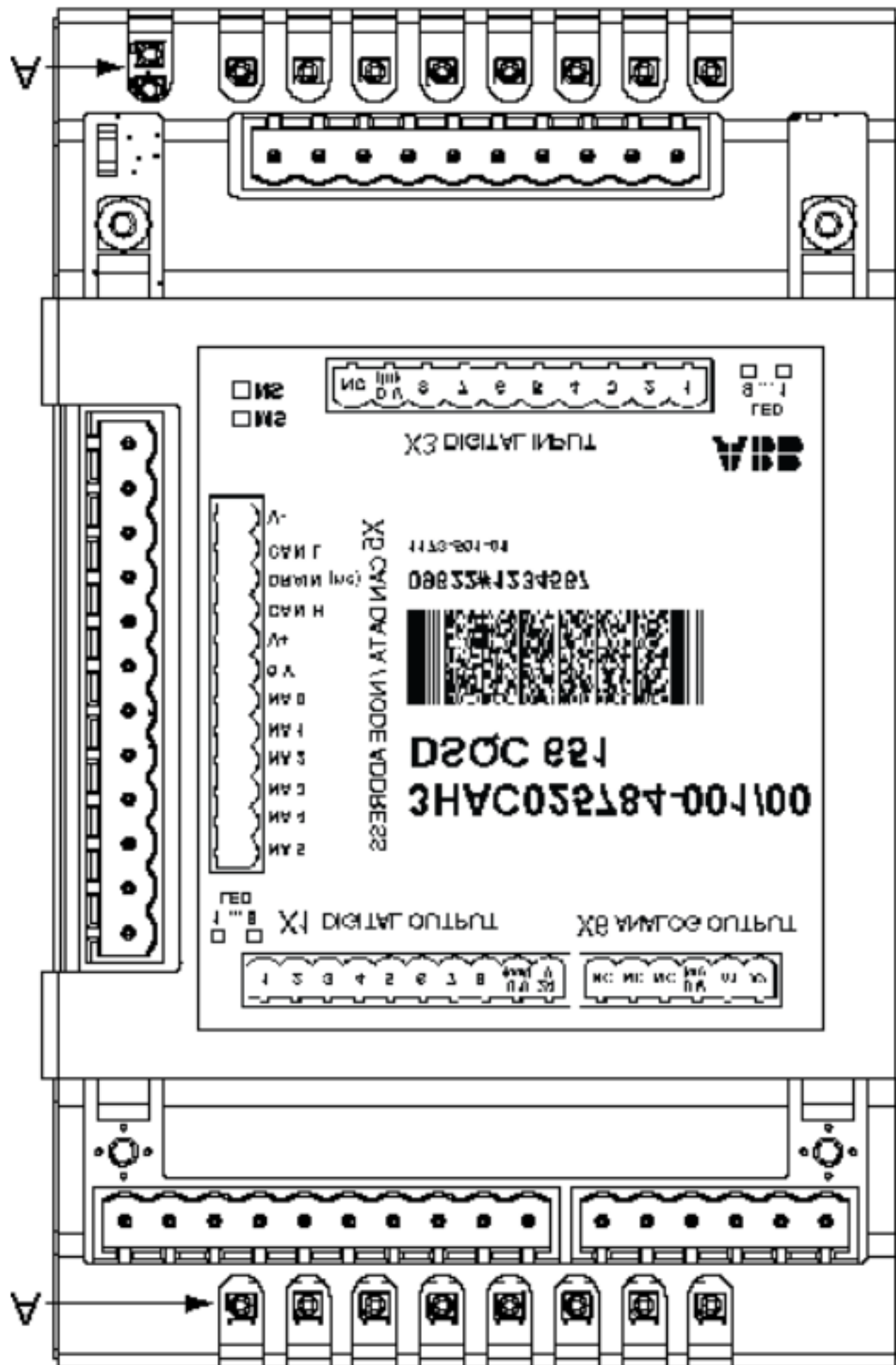

xx0600002853

Continues on next page

## 6 Boards and devices

### 6.2.5 DSQC 651, AD combi I/O

Continued

#### Parts

Item	Description
A	Status LEDs
X1	Digital outputs
X3	Digital inputs
X5	DeviceNet connector
X6	Analog outputs

#### Facts, DSQC 651

This section specifies a number of facts applicable to the DSQC 651. Unless stated otherwise, the data applies to the standard version.

#### Technical data

Digital inputs	<p>Number of digital inputs: 8</p> <p>Rated voltage: ? 24 VDC</p> <p>Input voltage range: ? "1" ---&gt; 15 to 35 V ? "0" ---&gt; -35 to 5 V</p> <p>Input current at rated voltage: ? Typical ---&gt; 5 mA (approx)</p> <p>Switch-over level: ? Typical ---&gt;12V (approx)</p> <p>Delay (with default filtering): ? Typical ---&gt;5 ms ? minimum ---&gt;4 ms ? maximum ---&gt;6ms</p> <p>Power dissipation or channel at rated voltage: ? Typical ---&gt;150 mW (approx)</p>
Digital outputs	<p>Number of digital outputs: 8</p> <p>Short-circuit protected outputs with current limitation and thermal overload protection. Miswiring protection +35V to -35V connected to output.</p> <p>Rated voltage: ? 24 VDC</p> <p>Voltage drop over output: ? maximum ---&gt; 0.5V with 500mA</p> <p>Rated output current: ? 500 mA/channel</p> <p>Current limit: ? Typical ---&gt; 1.4A</p> <p>Leakage current: ? maximum ---&gt; 0.1 mA</p> <p>Delay output: ? maximum ---&gt; 0.5 ms</p>

Continues on next page



Analog outputs	<p>Number of analog outputs: 2 (galvanically isolated from the controller electronics)</p> <p>Short-circuit protected outputs</p> <p>Output voltage: ? 0-10 VDC</p> <p>Load Impedance: ? min 2 kohm</p> <p>Resolution: ? 12 bits</p> <p>Inaccuracy (Over temperature range + 5 C to +70 C): ? maximum 25 cmV (0.5 % of full scale)</p>
Supply voltage	24 VDC
Power supply, digital, and analog I/O	<p>Integrated power supply in controller.</p> <p>Separate 24 VDC power, supplied by customer in non-ABB external I/O device.</p>
External supply for digital outputs	<p>Reverse polarity protection.</p> <p>Voltage: ? 19 - 35 V</p>
Analog supply	<p>Analog supply +16/-8V internally on the board.</p> <p>From the DeviceNet cable 24 Volt. DC/DC converter "flyback "</p> <p>Isolation voltage: ? 500 VDC</p> <p>Voltage: ? 16 V / -8V</p> <p>Current consumption: ? 40mA (approx)</p>
SW connections	<p>Support for the following connections:</p> <ul style="list-style-type: none"> <li>? POLLED</li> <li>? Change-Of-State</li> <li>? Change-Of-State with acknowledge suppression</li> <li>? Cyclic</li> <li>? Cyclic with acknowledge suppression</li> </ul> <p>For descriptions of the different types of I/O connections, see I/O messages - connection types on page 15.</p>
Baud rate	<p>Autodetect; the device will detect the baud rate automatically.</p> <p> Note</p> <p>When the master baud rate is changed disconnect the power to the device(s) before the system is restarted, reconnect the power when the master is up and running.</p> <p>This is required for the device(s) to be able to establish a new connection with the master.</p>

### Device setup

The device must be given an address, and setup parameters must be entered into the system.

Continues on next page

## 6 Boards and devices

### 6.2.5 DSQC 651, AD combi I/O

Continued

#### Connector X1

If supervision of the supply voltage is required, a bridge connection can be made to an optional digital input. This also requires the particular device to have a separate power supply, in order to be able to monitor the regular power supply voltage.

The supervision instruction must be written in the RAPID program.

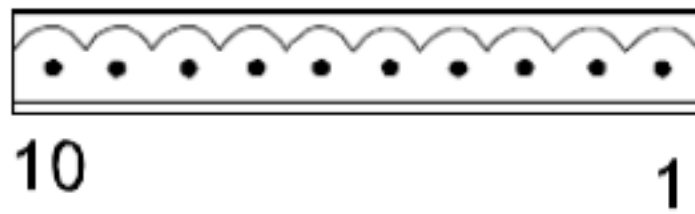

xx0200000264

The following table shows the connections to connector X1:

Device function	Signal name	X1 pin
Optically isolated output	Out ch 1	1
Optically isolated output	Out ch 2	2
Optically isolated output	Out ch 3	3
Optically isolated output	Out ch 4	4
Optically isolated output	Out ch 5	5
Optically isolated output	Out ch 6	6
Optically isolated output	Out ch 7	7
Optically isolated output	Out ch 8	8
Optically isolated output	0 V for outputs	9
Optically isolated output	24 V for outputs	10

#### Connector X3

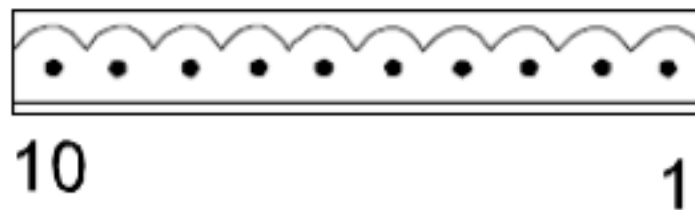

xx0200000264

The following table shows the connections to connector X3:

Device function	Signal name	X3 pin
Optically isolated input	In ch 1	1
Optically isolated input	In ch 2	2
Optically isolated input	In ch 3	3
Optically isolated input	In ch 4	4
Optically isolated input	In ch 5	5
Optically isolated input	In ch 6	6
Optically isolated input	In ch 7	7
Optically isolated input	In ch 8	8
Optically isolated input	0 V for inputs	9

Continues on next page

Device function	Signal name	X3 pin
Optically isolated input	Not used	10

The input current is 5.5 mA (at 24 V) on the digital inputs. A capacitor connected to ground, to prevent disturbances, causes a short rush of current when setting the input.

When connecting outputs, sensitive to pre-oscillation current, a series resistor (100 Ohms) may be used.

#### Connector X5



xx0100000244

Connector X5 is a DeviceNet connector specified in section Setting DeviceNet network ID on page 52.

#### Connector X6

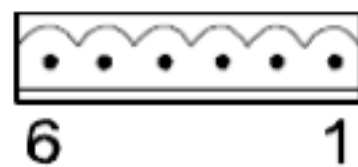

xx0200000265

The following table shows the connections to connector X6:

Signal name	X6 pin	Explanation
-	1	No connection
-	2	No connection
-	3	No connection
0 VA	4	0 V for Out channels 1-2
AN_OCH1	5	Out channels 1
AN_OCH2	6	Out channels 2

#### LEDs

The significance of the LEDs are specified in section DeviceNet network and I/O board status LED description on page 47.

#### Input map

The following figure shows the digital input mapping.

Input byte	Bit								Bit range
	7	6	5	4	3	2	1	0	
0	DI 8	DI 7	DI 6	DI 5	DI 4	DI 3	DI 2	DI 1	0-7

Continues on next page

## 6 Boards and devices

### 6.2.5 DSQC 651, AD combi I/O

Continued

#### Output map

The following figure shows the analog and digital output mapping.

 **Note**  
 Pay attention to the order of the bits for the analog signals.

Output byte	Bit								Bit range
	7	6	5	4	3	2	1	0	
0	LSB								0-15
1	AO 1								
	MSB								
2	LSB								16-31
3	AO 2								
	MSB								
4	DO 8	DO 7	DO 6	DO 5	DO 4	DO 3	DO 2	DO 1	32-39

en0600002851

LSB	The least significant bit of the binary number representing the analog signal.
MSB	The most significant bit of the binary number representing the analog signal.

#### Numerical format

The numerical representation of the values are described in the following table:

Signal	Analog physical value	Hexadecimal number	Bit value
AO 1-AO 2	+10 V	0xFFFF	MaxBitVal = 65535
AO 1-AO 2	+5 V	0x7FFF	
AO 1-AO 2	0 V	0x0	MinBitVal = 0

#### Electronic Data Sheet

The Electronic Data Sheet for the DeviceNet Master/Slave devices, matching the configuration of DSQC 651, dsqc651.eds, can be obtained from the PC or the IRC5 controller. For more information see EDS file on page 29.

#### Additional information

The following table shows the physical type of the signals, resolution, and so on.

Signal	Type	Range	Resolution	Encoding type
AO 1	Voltage	0 V .. +10 V	12 bit	Unsigned
AO 2	Voltage	0 V .. +10 V	12 bit	Unsigned

6.2.6 DSQC 652, Digital I/O

Description

The DSQC 652 is a circuit board normally mounted inside the robot controller. As an option, it may also be mounted in an external I/O module.

The device handles digital input and output signals between the robot system and any external systems.

Illustration of DSQC 652

The following figure shows the DSQC 652 board:

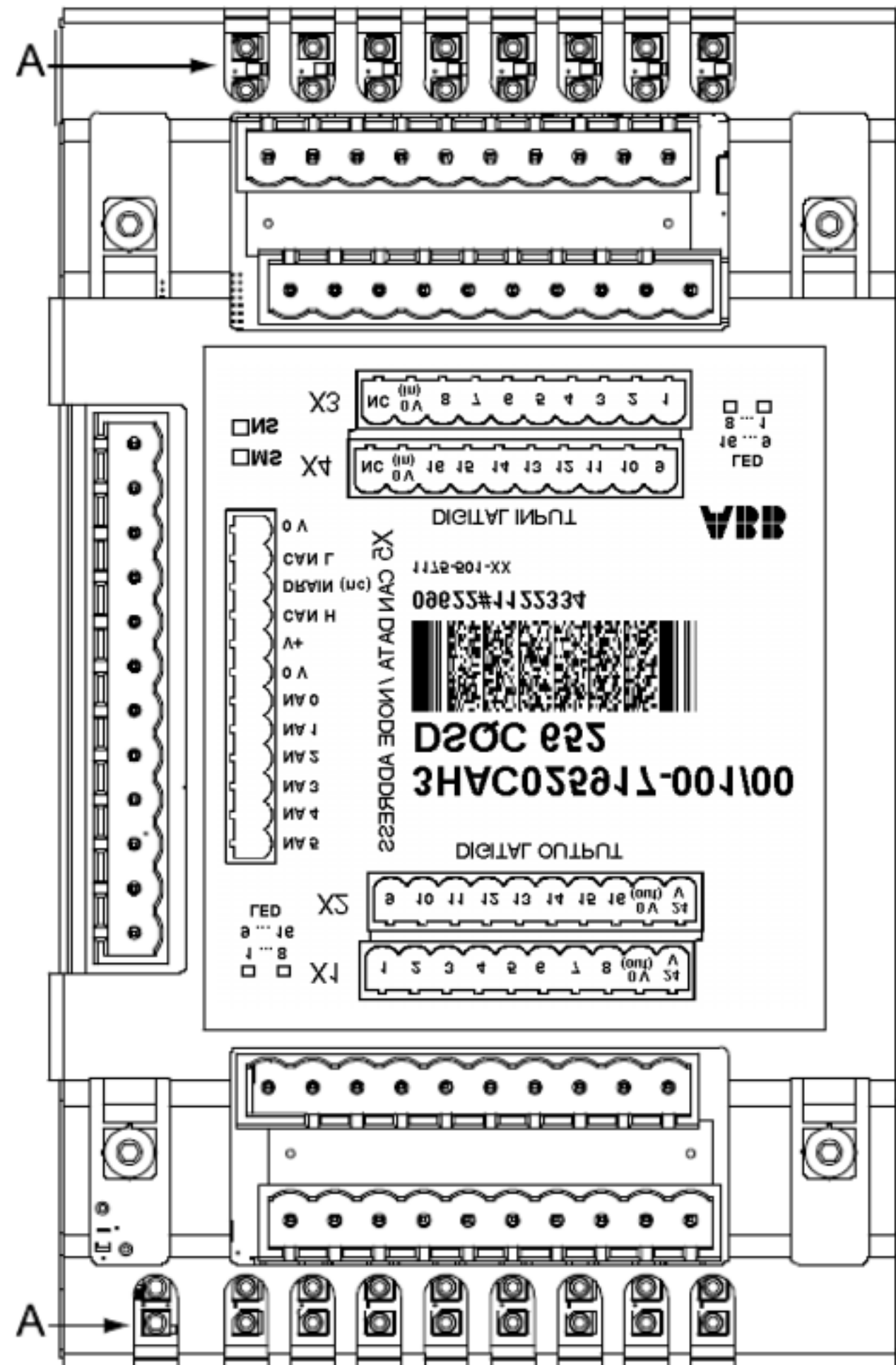

xx0600002855

Continues on next page

## 6 Boards and devices

### 6.2.6 DSQC 652, Digital I/O

Continued

#### Parts

Item	Description
A	Status LEDs
X1	Digital outputs
X2	Digital outputs
X3	Digital inputs
X4	Digital inputs
X5	DeviceNet connector

#### Facts, DSQC 652

This section specifies a number of facts applicable to the DSQC 652. Unless stated otherwise, the data applies to the standard version.

#### Technical data

Digital inputs	Number of digital inputs: 16 Rated voltage: ? 24 VDC Input voltage range: ? "1" ---> 15 to 35 V ? "0" ---> -35 to 5 V Input current at rated voltage: ? Typical ---> 5 mA (approx) Switch-over level: ? Typical --->12V (approx) Delay (with default filtering): ? Typical --->5 ms ? minimum --->4 ms ? maximum --->6ms Power dissipation or channel at rated voltage: ? Typical --->150 mW (approx)
Digital outputs	Number of digital inputs: 16 Short-circuit protected outputs with current limitation and thermal overload protection. Miswiring protection +35V to -35V connected to output. Rated voltage: ? 24 VDC Voltage drop over output: ? maximum ---> 0.5V with 500mA Rated output current: ? 500 mA/channel Current limit: ? Typical ---> 1.4A Leakage current: ? maximum ---> 0.1 mA Delay output: ? maximum ---> 0.5 ms
Supply voltage	24 VDC
Supply source	24 V I/O or separate external supply

Continues on next page

External supply for digital outputs Reverse polarity protection.	Voltage: ? 19 - 35 V
SW connections	Support for the following connections: ? Polled ? Change-Of-State ? Change-Of-State with acknowledge suppression ? Cyclic ? Cyclic with acknowledge suppression  For descriptions of the different types of I/O connections, see I/O messages - connection types on page 15.
Baudrate	Autodetect; the device will detect the baud rate automatically.   Note  When the master baud rate is changed disconnect the power to the device(s) before the system is restarted, reconnect the power when the master is up and running.  This is required for the device(s) to be able to establish a new connection with the master.

## Device setup

The device must be given an address, and setup parameters must be entered into the system.

## Connector X1

If supply voltage supervision is required, a bridge connection can be made to an optional digital input. The supervision instruction must be written in the RAPID program.



xx0200000264

The following table shows the connections to connector X1:

Device function	Signal name	X1 pin
Optically isolated output	Out ch 1	1
Optically isolated output	Out ch 2	2
Optically isolated output	Out ch 3	3
Optically isolated output	Out ch 4	4
Optically isolated output	Out ch 5	5
Optically isolated output	Out ch 6	6
Optically isolated output	Out ch 7	7
Optically isolated output	Out ch 8	8
Optically isolated output	0 V for outputs	9
Optically isolated output	24 V for outputs	10

Continues on next page

## 6 Boards and devices

### 6.2.6 DSQC 652, Digital I/O

Continued

#### Connector X2

If supply voltage supervision is required, a bridge connection can be made to an optional digital input. The supervision instruction must be written in the RAPID program.



xx0200000264

The following table shows the connections to connector X2:

Device function	Signal name	X2 pin
Optically isolated output	Out ch 9	1
Optically isolated output	Out ch 10	2
Optically isolated output	Out ch 11	3
Optically isolated output	Out ch 12	4
Optically isolated output	Out ch 13	5
Optically isolated output	Out ch 14	6
Optically isolated output	Out ch 15	7
Optically isolated output	Out ch 16	8
Optically isolated output	0 V for outputs	9
Optically isolated output	24 V for outputs	10

#### Connector X3

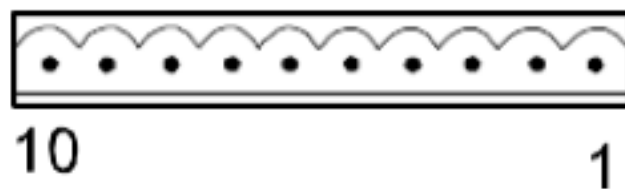

xx0200000264

The following table shows the connections to connector X3:

Device function	Signal name	X3 pin
Optically isolated input	In ch 1	1
Optically isolated input	In ch 2	2
Optically isolated input	In ch 3	3
Optically isolated input	In ch 4	4
Optically isolated input	In ch 5	5
Optically isolated input	In ch 6	6
Optically isolated input	In ch 7	7
Optically isolated input	In ch 8	8
Optically isolated input	0 V for inputs	9
Optically isolated input	Not used	10

Continues on next page



The input current is 5.5 mA (at 24 V) on the digital inputs. A capacitor connected to ground, to prevent disturbances, causes a short rush of current when setting the input.

When connecting outputs, sensitive to pre-oscillation current, a series resistor (100 Ohms) may be used.

#### Connector X4

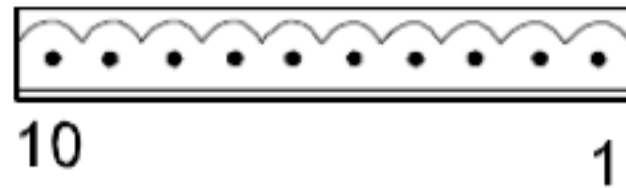

xx020000264

The following table shows the connections to connector X4:

Device function	Signal name	X4 pin
Optically isolated input	In ch 9	1
Optically isolated input	In ch 10	2
Optically isolated input	In ch 11	3
Optically isolated input	In ch 12	4
Optically isolated input	In ch 13	5
Optically isolated input	In ch 14	6
Optically isolated input	In ch 15	7
Optically isolated input	In ch 16	8
Optically isolated input	0 V for inputs	9
Optically isolated input	Not used	10

The input current is 5.5 mA (at 24 V) on the digital inputs. A capacitor connected to ground, to prevent disturbances, causes a short rush of current when setting the input.

When connecting outputs, sensitive to pre-oscillation current, a series resistor (100 ohms) may be used.

#### Connector X5

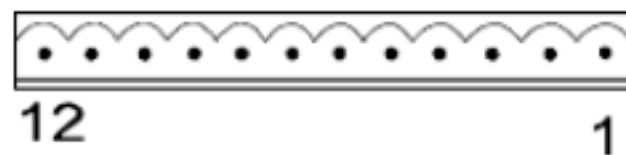

xx010000244

Connector X5 is a DeviceNet connector specified in section Setting DeviceNet network ID on page 52.

#### LEDs

The significance of the LEDs are specified in section DeviceNet network and I/O board status LED description on page 47.

Continues on next page

## 6 Boards and devices

---

### 6.2.6 DSQC 652, Digital I/O

Continued

#### Input map

The following figure shows the digital input mapping.

Input byte	Bit								Bit range
	7	6	5	4	3	2	1	0	
0	DI 8	DI 7	DI 6	DI 5	DI 4	DI 3	DI 2	DI 1	0-7
1	DI 16	DI 15	DI 14	DI 13	DI 12	DI 11	DI 10	DI 9	8-15

xx0300000613

#### Output map

The following figure shows the digital output mapping.

Output byte	Bit								Bit range
	7	6	5	4	3	2	1	0	
0	DO 8	DO 7	DO 6	DO 5	DO 4	DO 3	DO 2	DO 1	0-7
1	DO 16	DO 15	DO 14	DO 13	DO 12	DO 11	DO 10	DO 9	8-15

en0400000716

#### Electronic Data Sheet

The Electronic Data Sheet for the DeviceNet Master/Slave devices, matching the configuration of DSQC 652, dsqc652.eds, can be obtained from the PC or the IRC5 controller. For more information see EDS file on page 29.

6.2.7 DSQC 653, Digital I/O with relay outputs

Description

The DSQC 653 is a circuit board normally mounted inside the robot controller. As an option, it may also be mounted in an external I/O module.

The device handles input and output signals between the robot system and any external systems through relay outputs and digital inputs.

Illustration DSQC 653

The following figure shows the DSQC 653 board:

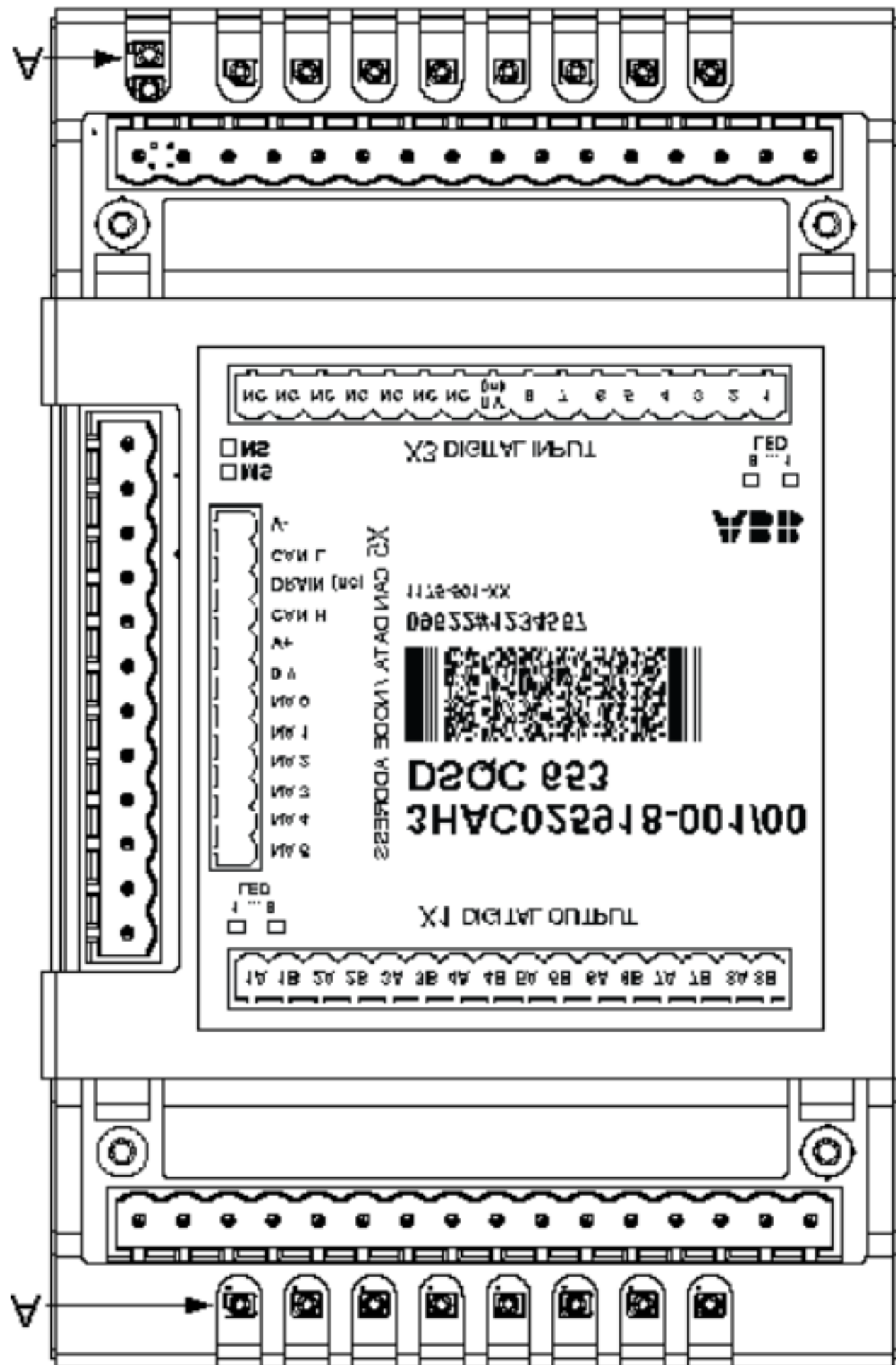

xx0600002857

Continues on next page

## 6 Boards and devices

### 6.2.7 DSQC 653, Digital I/O with relay outputs

Continued

#### Parts

Item	Description
A	Status LEDs
X1	Relay outputs
X3	Digital inputs
X5	DeviceNet connector

#### Facts, DSQC 653

This section specifies a number of facts applicable to the DSQC 653. Unless stated otherwise, the data applies to the standard version.

#### Technical data

Digital inputs	Number of digital inputs: 8 Rated voltage: ? 24 VDC Input voltage range: ? "1" ---> 15 to 35 V ? "0" ---> -35 to 5 V Input current at rated voltage: ? Typical ---> 5 mA (approx) Switch-over level: ? Typical --->12V (approx) Delay (with default filtering): ? Typical --->5 ms ? minimum --->4 ms ? maximum --->6ms Power dissipation or channel at rated voltage: ? Typical --->150 mW (approx)
Relay outputs	Number of relay outputs: 8 Single pole with one make contact (normally open) Rated voltage ? 24 VDC/120 VAC rms Rated output current ? 2 A/channel Output load ? minimum 2.5 VA/channel Delay time on board ? Typical - 6 ms (make contact), 7 ms (break contact)
Supply voltage	24 VDC
Supply source	24 V I/O or separate external supply
External supply for relay outputs	Voltage ? 19 - 35 VDC, 24 - 140 VAC rms
SW connections	Support for the following connections: ? Polled ? Change-Of-State ? Change-Of-State with acknowledge suppression ? Cyclic ? Cyclic with acknowledge suppression For descriptions of the different types of I/O connections, see I/O messages - connection types on page 15.

Continues on next page

Baud rate	<p>Autodetect; the device will detect the baud rate automatically.</p> <p> <b>Note</b></p> <p>When the master baud rate is changed disconnect the power to the device(s) before the system is restarted, reconnect the power when the master is up and running.</p> <p>This is required for the device(s) to be able to establish a new connection with the master.</p>
-----------	--

### Device setup

The device must be given an address, and setup parameters must be entered into the system.

### Connecting digital outputs and digital inputs

The following illustration shows how to connect the relay outputs for the connector X1. When a bit is set to 1, the relay output will be activated.

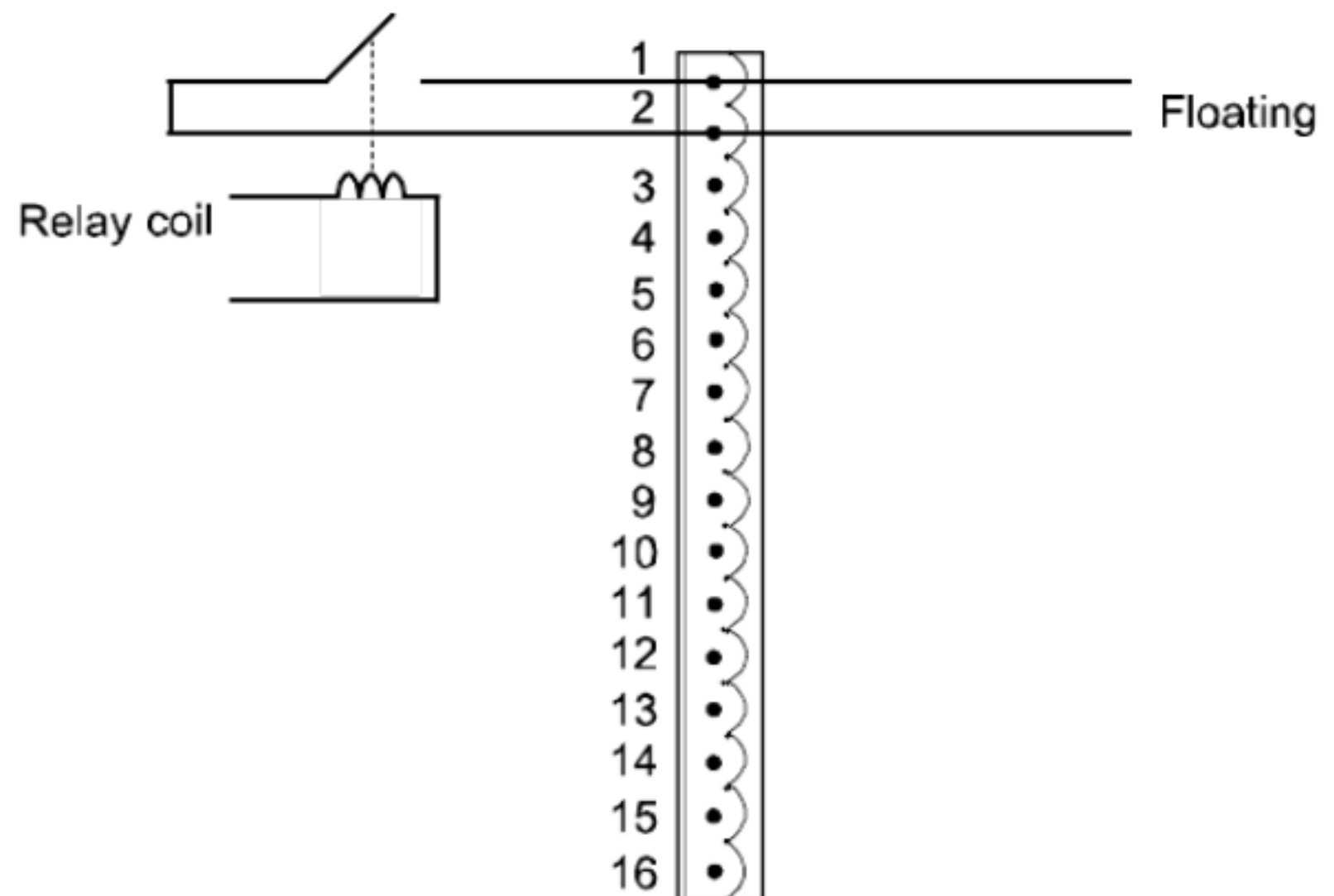

en0500001565

Continues on next page

## 6 Boards and devices

### 6.2.7 DSQC 653, Digital I/O with relay outputs

Continued

The following illustration shows how to connect the digital inputs for the connector X3.

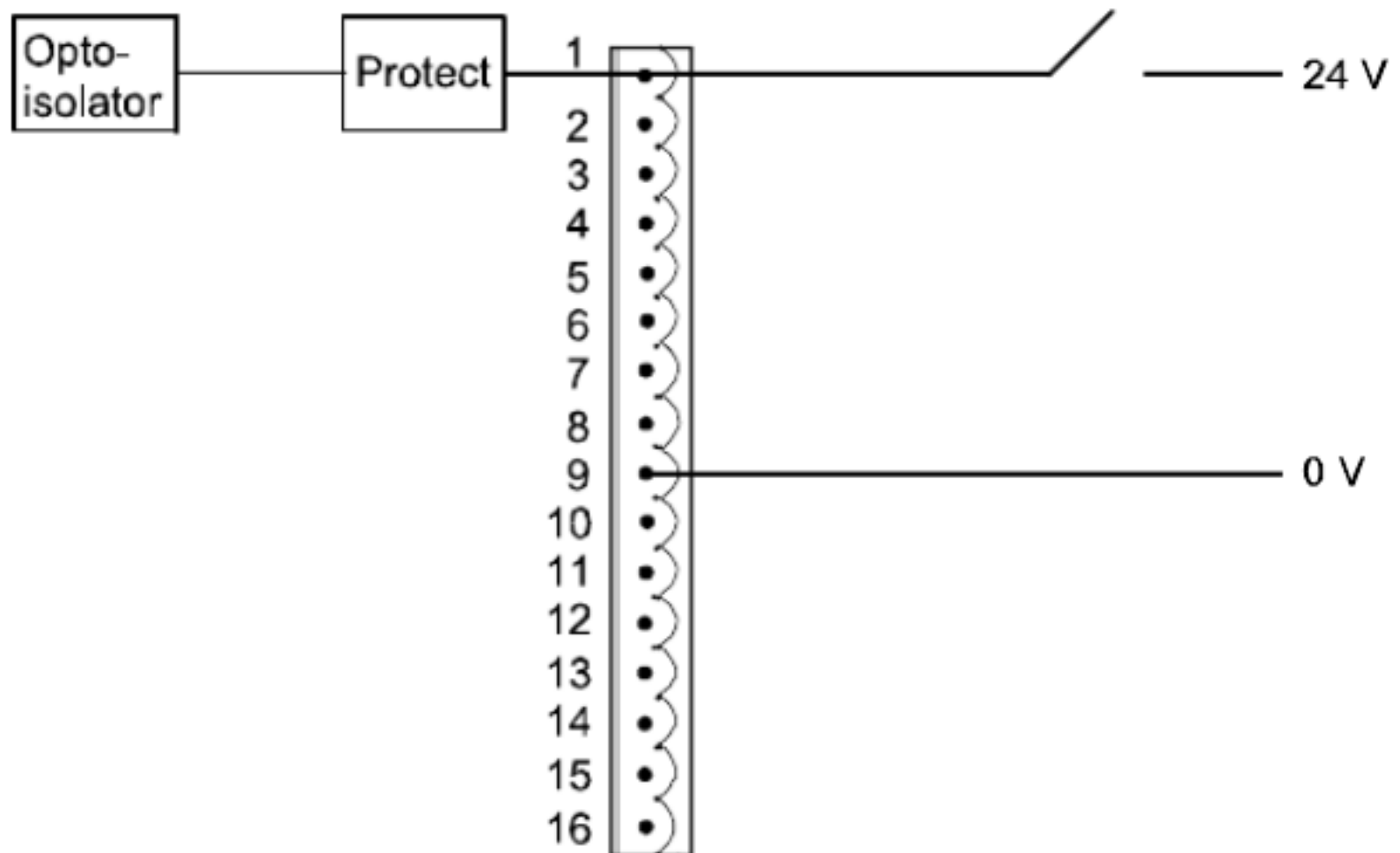

en0500001566

#### Connector X1



xx0100000235

The following table shows the connections to connector X1:

Signal name	X1 pin	Function
Out ch 1a	1	Contact, relay 1
Out ch 1b	2	Contact, relay 1
Out ch 2a	3	Contact, relay 2
Out ch 2b	4	Contact, relay 2
Out ch 3a	5	Contact, relay 3
Out ch 3b	6	Contact, relay 3
Out ch 4a	7	Contact, relay 4
Out ch 4b	8	Contact, relay 4
Out ch 5a	9	Contact, relay 5
Out ch 5b	10	Contact, relay 5
Out ch 6a	11	Contact, relay 6
Out ch 6b	12	Contact, relay 6
Out ch 7a	13	Contact, relay 7
Out ch 7b	14	Contact, relay 7
Out ch 8a	15	Contact, relay 8

Continues on next page

Signal name	X1 pin	Function
Out ch 8b	16	Contact, relay 8

## Connector X3



xx010000235

The following table shows the connections to connector X3:

Signal name	X3 pin
In ch 1	1
In ch 2	2
In ch 3	3
In ch 4	4
In ch 5	5
In ch 6	6
In ch 7	7
In ch 8	8
0 v for inputs	9
Not used	10
Not used	11
Not used	12
Not used	13
Not used	14
Not used	15
Not used	16

The input current is 5.5 mA (at 24 V) on the digital inputs. A capacitor connected to ground, to prevent disturbances, causes a short rush of current when setting the input.

When connecting outputs, sensitive to pre-oscillation current, a series resistor (100 Ohms) may be used.

## Connector X5



xx010000244

Connector X5 is a DeviceNet connector specified in section Setting DeviceNet network ID on page 52.

Continues on next page

## 6 Boards and devices

---

### 6.2.7 DSQC 653, Digital I/O with relay outputs

Continued

#### LEDs

The significance of the LEDs are specified in section DeviceNet network and I/O board status LED description on page 47.

#### Input map

The following figure shows the digital input mapping.

Input byte	Bit								Bit range
	7	6	5	4	3	2	1	0	
0	DI 8	DI 7	DI 6	DI 5	DI 4	DI 3	DI 2	DI 1	0-7

en0600002850

#### Output map

The following figure shows the digital output mapping.

Output byte	Bit								Bit range
	7	6	5	4	3	2	1	0	
0	DO 8	DO 7	DO 6	DO 5	DO 4	DO 3	DO 2	DO 1	0-7

en0600002849

#### Electronic Data Sheet

The Electronic Data Sheet for the DeviceNet Master/Slave devices, matching the configuration of DSQC 653, dsqc653.eds, can be obtained from the PC or the IRC5 controller. For more information see EDS file on page 29.



## 7 System parameters

### 7.1 Introduction

#### About the system parameters

There are both DeviceNet specific parameters and general I/O parameters. This chapter describes all DeviceNet specific system parameters. The parameters are divided into the type they belong to.

For information about other system parameters, see Technical reference manual - System parameters .

#### DeviceNet system parameters

##### Industrial Network

These parameters belong to the type Industrial Network in the topic I/O System .

Parameter	For more information, see ...
Name	Technical reference manual - System parameters
Identification Label	Technical reference manual - System parameters
Address	Address on page 99
DeviceNet Communication Speed	DeviceNet Communication Speed on page 100

##### DeviceNet Device

These parameters belong to the type DeviceNet Device in the topic I/O System .

Parameter	For more information, see ...
Name	Technical reference manual - System parameters
Connected to Industrial Network	Technical reference manual - System parameters
State when System Startup	Technical reference manual - System parameters
Trust Level	Technical reference manual - System parameters
Simulated	Technical reference manual - System parameters
Vendor Name	Technical reference manual - System parameters
Product Name	Technical reference manual - System parameters
Recovery Time	Technical reference manual - System parameters
Identification Label	Technical reference manual - System parameters
Address	Address on page 101
Vendor ID	Vendor ID on page 102
Product Code	Product Code on page 103
Device Type	Device Type on page 104
Production Inhibit Time	Production Inhibit Time on page 105
Connection Type	Connection Type on page 106
Poll Rate	Poll Rate on page 107

Continues on next page

## 7 System parameters

---

### 7.1 Introduction

Continued

Parameter	For more information, see ...
Connection Output Size	Connection Output Size on page 108
Connection Input Size	Connection Input Size on page 109
Quick Connect	Quick Connect on page 110

#### DeviceNet Internal Device

These parameters belong to the type DeviceNet Internal Device in the topic I/O System .

Parameter	For more information, see ...
Name	Technical reference manual - System parameters
Connected to Industrial Network	Technical reference manual - System parameters
Vendor Name	Technical reference manual - System parameters
Product Name	Technical reference manual - System parameters
Identification Label	Technical reference manual - System parameters
Connection Output Size	Connection Output Size on page 112
Connection Input Size	Connection Input Size on page 111

#### DeviceNet Command

These parameters belong to the type DeviceNet Command in the topic I/O System .

Parameter	For more information, see ...
Name	Technical reference manual - System parameters
Device	Technical reference manual - System parameters
Download Order	Technical reference manual - System parameters
Path	Path on page 113
Service	Service on page 115
Value	Technical reference manual - System parameters

## 7.2 Type Industrial Network

### 7.2.1 Address

#### Parent

Address belongs to the type Industrial Network , in the topic I/O System .

#### Cfg name

Address

---

#### Description

Address is mandatory for a DeviceNet industrial network and decides what address the DeviceNet master and the internal slave device should use to communicate with other devices on the DeviceNet network.

#### Usage

This address is the address that the DeviceNet master and the internal slave device uses to communicate.

---

#### Prerequisites

The option DeviceNet Master/Slave must be installed.

---

#### Limitations

The Address should not use the same address as another I/O device on the network.

---

#### Default value

The default value is 2.

---

#### Allowed values

Allowed values are the integers 0-63.

## 7 System parameters

---

### 7.2.2 DeviceNet Communication Speed

### 7.2.2 DeviceNet Communication Speed

---

#### Parent

DeviceNet Communication Speed belongs to the type Industrial Network , in the topic I/O System .

---

#### Cfg name

BaudRate

---

#### Description

DeviceNet Communication Speed is mandatory for a DeviceNet industrial network and decides what communication speed (baud rate) the DeviceNet master and the internal slave device should use to communicate with other devices on the DeviceNet network.

---

#### Usage

The baud rate is the signalling speed of the communication, and determines the maximum speed of the data transfer in serial channels. The higher the baud rate is, the faster the communication can be.

---

#### Prerequisites

The option DeviceNet Master/Slave must be installed.

---

#### Limitations

When using DeviceNet Communication Speed , all devices on the same physical network must use the same baud rate.

---

#### Default value

The default value is 500.

---

#### Allowed values

Allowed values are 125, 250, and 500, specifying the baud rate in Kbps (kilobits per second).

---

## 7.3 Type DeviceNet Device

### 7.3.1 Address

#### Parent

Address belongs to the type Device , in the topic I/O System .

#### Cfg name

Address

---

#### Description

Address specifies the address that the I/O device is assumed to be using on the network, and which the master should try to setup a connection against.

---

#### Usage

Address is a DeviceNet specific parameter that is only available for DeviceNet devices.

---

#### Prerequisites

The option DeviceNet Master/Slave must be installed.

---

#### Limitations

All addresses on a DeviceNet network must be unique, the only exception is that the master and the internal slave device share the same address.

---

#### Default value

The default value is 63.

---

#### Allowed values

Allowed values are the integers 0-63.

## 7 System parameters

---

### 7.3.2 Vendor ID

### 7.3.2 Vendor ID

---

#### Parent

Vendor ID belongs to the type Device , in the topic I/O System .

---

#### Cfg name

VendorId

---

#### Description

Vendor ID is used as an identification of the I/O device to secure communication to the correct type of device.

---

#### Usage

This parameter is used as an identification of the I/O device to secure communication to the correct device.

The value of Vendor ID can be found in the Electronic Data Sheet (EDS) for the device (called VendCode in EDS file), or by using a predefined device template.

---

#### Prerequisites

The option DeviceNet Master/Slave must be installed.

#### Default value

The default value is 0.

---

#### Allowed values

Allowed values are the integers 0-65535.

---

#### Additional information

The I/O device vendor number is assigned by Open DeviceNet Vendor Associations (ODVA) to the vendor of the specific I/O device.

---

### 7.3.3 Product Code

---

#### Parent

Product Code belongs to the type Device , in the topic I/O System .

---

#### Cfg name

ProductCode

---

#### Description

Product Code is used as an identification of the I/O device to secure communication to the correct I/O device.

---

#### Usage

This parameter is used as an identification of the I/O device to secure communication to the correct device.

The value of Product Code can be found in Electronic Data Sheet (EDS) for the device (called ProdCode in EDS file), or by using a predefined device template.

---

#### Prerequisites

The option DeviceNet Master/Slave must be installed.

---

#### Default value

Default value is 0.

---

#### Allowed values

Allowed values are the integers 0-65535.

---

#### Additional information

The device product code is defined by the vendor of the device and shall be unique for the actual product type.

## 7 System parameters

---

### 7.3.4 Device Type

### 7.3.4 Device Type

---

#### Parent

Device Type belongs to the type Device , in the topic I/O System .

---

#### Cfg name

DeviceType

---

#### Description

The parameter Device Type specifies the device type of this I/O device as defined by the Open DeviceNet Vendor Association.

---

#### Usage

This parameter is used as an identification of the I/O device to secure communication to the correct device.

The value of this parameter can be found in the Electronic Data Sheet (EDS) for the device (called ProdType in EDS file), or by using a predefined device template.

---

#### Prerequisites

The option DeviceNet Master/Slave must be installed.

#### Default value

The default value is 0.

---

#### Allowed values

Allowed values are the integers 0-65535.

---



---

### 7.3.5 Production Inhibit Time

---

#### Parent

Production Inhibit Time belongs to the type Device , in the topic I/O System .

---

#### Cfg name

ProductionInhibitTime

---

#### Description

Production Inhibit Time specifies the minimum time, expressed in milliseconds, between network messages sent by the device.

---

#### Usage

Production Inhibit Time is used to control the minimum time between transmissions from the I/O device in order to prevent overloading of the DeviceNet network. This parameter is only applicable when connection type is set to Change-Of-State (COS) connection or Change-Of-State with acknowledge suppression.

---

#### Prerequisites

The option DeviceNet Master/Slave must be installed.

#### Limitations

Maximum and minimum values might be constrained by the device. This parameter is not applicable when connection type is set to polled or strobe connection.

#### Default value

The default value is 10.

---

#### Allowed values

Allowed values are the integers 0-65535.

## 7 System parameters

---

### 7.3.6 Connection Type

### 7.3.6 Connection Type

---

#### Parent

Connection Type belongs to the type Device , in the topic I/O System .

---

#### Cfg name

ConnectionType

---

#### Description

Connection Type specifies the type of the first connection that should be established to the device.

---

#### Usage

Connection Type is used to define the communication scheme used towards the I/O device. The different connection types are described in the ODVA DeviceNet specification (Open DeviceNet Vendor Associations).

The type of connection supported by the I/O device can either be found in the [IO\_Info] section of the Electronic Data Sheet (EDS) for the device, or by using a predefined device template.

---

#### Prerequisites

The option DeviceNet Master/Slave must be installed.

---

#### Limitations

All connection types may not be supported by device.

---

#### Default value

The default value is Polled connection.

---

#### Allowed values

Allowed values are:

- ? Polled connection
  - ? Strobe connection
  - ? Change-Of-State (COS) connection
  - ? Cyclic connection
  - ? Change-Of-State with Acknowledge Suppression
  - ? Cyclic with Acknowledge Suppression
-

---

### 7.3.7 Poll Rate

---

#### Parent

Poll Rate belongs to the type Device , in the topic I/O System .

---

#### Cfg name

PollRate

---

#### Description

Poll Rate defines the cyclicity of the communication over the first connection.

---

#### Usage

Poll Rate is used to optimize network bandwidth and I/O update rates.



#### Note

When using a polled connection on DeviceNet Master/Slave a DO signal will be updated directly on a device.

---

#### Prerequisites

The option DeviceNet Master/Slave must be installed.

---

#### Limitations

Maximum and minimum values might be constrained by the device.

---

#### Default value

The default value is 1000.

---

#### Allowed values

Allowed values are the integers 0-65535, specifying the time in milliseconds.

## 7 System parameters

---

### 7.3.8 Connection Output Size

### 7.3.8 Connection Output Size

---

#### Parent

Connection Output Size belongs to the type Device , in the topic I/O System .

---

#### Cfg name

OutputSize

---

#### Description

Connection Output Size defines the data size that is transmitted to the device over the first connection.

---

#### Usage

The value of Connection Output Size can either be found in the [IO\_Info] section of the Electronic Data Sheet (EDS) for the device, or by using a predefined device template.

---

#### Prerequisites

The option DeviceNet Master/Slave must be installed.

---

#### Limitations

Maximum and minimum values might be constrained by the device.

#### Default value

Default value is 0.

---

#### Allowed values

Allowed values are the integers 0-64 (0-512 signal bits), specifying the data size in bytes.

For devices that can give the device size itself by an explicit message, the value -1 is also allowed.

---

### 7.3.9 Connection Input Size

---

#### Parent

Connection Input Size belongs to the type Device , in the topic I/O System .

---

#### Cfg name

InputSize

---

#### Description

Connection Input Size defines the data size received from the device over the first connection.

---

#### Usage

The value of Connection Input Size can either be found in the [IO\_Info] section of the Electronic Data Sheet (EDS) for the device, or by using a predefined device template.

---

#### Prerequisites

The option DeviceNet Master/Slave must be installed.

---

#### Limitations

Maximum and minimum values might be constrained by the device.

---

#### Default value

The default value is 0.

---

#### Allowed values

Allowed values are the integers 0-64 (0-512 signal bits), specifying the data size in bytes.

For devices that can give the device size itself by an explicit message, the value -1 is also allowed.

## 7 System parameters

---

### 7.3.10 Quick Connect

#### 7.3.10 Quick Connect

---

##### Parent

Quick Connect belongs to the type Device , in the topic I/O System .

---

##### Cfg name

QuickConnect

---

##### Description

The Quick Connect parameter enables the quick connect option on the master side of a connection to a device.

---

##### Usage

Quick Connect is used to shorten the time when an I/O device is activated from a deactivated state.

---

##### Prerequisites

The option DeviceNet Master/Slave must be installed.

---

##### Default value

Default value is Deactivated.

---

##### Allowed values

Activated or Deactivated.

---

##### Additional information

To be able to use this option completely, the I/O device must support Quick Connect according to the ODVA DeviceNet Specification.

---

## 7.4 Type DeviceNet Internal Device

### 7.4.1 Connection Input Size

#### Parent

Connection Input Size belongs to the type DeviceNet Internal Device , in the topic I/O System .

#### Cfg name

InputSize

#### Description

Connection Input Size defines the data size in bytes for the input area received from the connected DeviceNet master.

#### Usage

Connection Input Size is a DeviceNet specific parameter.

---

#### Prerequisites

The option DeviceNet Master/Slave must be installed.

---

#### Default value

The default value is 8.

---

#### Allowed values

Allowed values are the integers 0-64, specifying the data size in bytes.

## 7 System parameters

---

### 7.4.2 Connection Output Size

### 7.4.2 Connection Output Size

---

#### Parent

Connection Output Size belongs to the type DeviceNet Internal Device , in the topic I/O System .

---

#### Cfg name

OutputSize

---

#### Description

Connection Output Size defines the data size in bytes for the output area sent to the DeviceNet master.

---

#### Usage

Connection Output Size is a DeviceNet specific parameter.

---

#### Prerequisites

The option DeviceNet Master/Slave must be installed.

---

#### Default value

Default value is 8.

---

#### Allowed values

Allowed values are the integers 0-64, specifying the data size in bytes.

---



---

## 7.5 Type DeviceNet Command

### 7.5.1 Path

#### Parent

Path belongs to the type DeviceNet Command , in the topic I/O System .

#### Cfg name

Path

---

#### Description

Path defines the path to DeviceNet object instance or attribute. Information about how to define this can usually be found in the [param] section of the EDS file.

---

#### Usage

Path is used to describe the path to the instance or attribute, the data type identifier and the data size that are to be affected by the explicit message.

---

#### Prerequisites

The option DeviceNet Master/Slave must be installed.

---

#### Default value

The default value is an empty string.

---

#### Allowed values

A string with maximum 30 characters.

Continues on next page

## 7 System parameters

---

### 7.5.1 Path

Continued

#### Related information

ODVA DeviceNet Specification 2.0.

---

#### Example

6,20 01 24 08 30 01,C6,1

Description of example:

- ? 6 is the length of the path - that is, the number of hexadecimal figures until the next comma.
- ? Path (20 01 24 08 30 01) is a software description of DeviceNet class, instance and attribute. A further description can be found in the ODVA DeviceNet Specification 2.0.
- ? C6 is the hexadecimal value for the data type identifier.
- ? 1 is the data size - that is, the number of bytes as a hexadecimal value.

---

## 7.5.2 Service

---

### Parent

Service belongs to the type DeviceNet Command , in the topic I/O System .

---

### Cfg name

Service

---

### Description

Service defines the explicit service that should be performed on DeviceNet object instance or attribute pointed out in Path .

---

### Usage

Service is used to define the type of action to be used.

---

### Prerequisites

The option DeviceNet Master/Slave must be installed.

---

### Default value

The default value is Set\_Attribute\_Single .

---

### Allowed values

Following values are allowed:

- ? Reset
- ? Create
- ? Apply\_Attributes
- ? Set\_Attribute\_Single

---

### Related information

Path on page 113.

This page is intentionally left blank

## 8 Trouble shooting

### 8.1 Bus off

#### Description

The master/slave channel goes bus off when an excessive number of communication errors are detected and the CAN chip automatically goes off-line. An event message will inform the users that bus off has occurred. The master/slave channel will automatically try to recover from bus off and if succeeded an event message will inform the user that the master/slave channel has recovered from bus off.

The network can be restarted from FlexPendant or RobotStudio. When the DeviceNet network is in error state, tap the Start button under Industrial Network in FlexPendant.

#### Consequences

Bus off indicates a serious communication fault such as incorrect baud rate or physical layer error (short, open etc.).

#### Possible causes

The symptom is caused by:

- ? Different baud rates on the master and some I/O devices (the I/O devices do not support auto baud rate).
- ? No power or faulty power on the network.
- ? Short circuit between CAN high and CAN low.
- ? Cable length on trunk cables and drop cables.
- ? Faulty terminations.

#### Recommended actions

In order to remedy the symptom, the following actions are recommended:

Cause	Action/Info
Different baud rates on the master and some devices. (The I/O devices do not support auto baud rate.)	Cycle the power of the devices or manually change the baud rate of the devices.
No power or faulty power on the network.	Refer to Shield grounding and power on page 21
Cable length on trunk cables and drop cables.	Refer to Selecting cables on page 25 or Repeaters on page 26.
Faulty terminations.	Refer to Termination resistors on page 23.



#### Note

If the master/slave channel goes bus off, the devices on the network also can go bus off. The only way to recover these devices is to cycle the power on the device (the behavior may be different depending on the manufacturer of the device).

### 8.2 Bus Scan

---

#### Overview

When a bus scan or automatic configuration operation is activated, the DeviceNet master will send requests to all valid network addresses. If the device is already configured against another DeviceNet master, or operating at wrong baud rate, or is not online, the device can not be contacted for the data gathering of the required configuration parameters. If the device is not found with automatic configuration, it might still be possible that the device will work if it is manually added.

# Index

## B

- bus off, 117
  - causes, 117
  - consequences, 117
  - remedy, 117

## C

- cable length, 25
- CCLink gateway, 71
- coil neutralization, 51
- connector X5, 52

## D

- DeviceNet, 15
  - connector, 52
  - I/O devices, 54
  - master, 38
  - network, 23
  - network ID, 52
  - predefined network, 31
  - specification overview, 17
- DeviceNet/CCLink gateway, 71
- DeviceNet/INTERBUS gateway, 55
- DeviceNet cable, 25
  - incoming, 24
  - outgoing, 24
- DeviceNet generic device template, 31, 43
- DeviceNet master
  - configuration, 38, 46
- Device Template, 31
- distributed I/O device, 54
- drop line, 24
  - extending the length, 27
- DSQC 351B, 55
- DSQC 377B, 62
- DSQC 378B, 71
- DSQC 651, 79
- DSQC 652, 85
- DSQC 653, 91

## E

- encoder interface units, 54
- explicit messages, 15

## G

- gateway
  - DeviceNet/CCLink gateway, 71
  - DeviceNet/INTERBUS gateway, 55

## I

- I/O devices, 28, 54
  - distributed I/O device, 54
  - DSQC 351B, 55
  - DSQC 377B, 62
  - DSQC 378B, 71
  - DSQC 651, 79
  - DSQC 652, 85
  - DSQC 653, 91
  - encoder interface devices, 54
- I/O messages, 15
  - change-of-state connection, 16
  - change-of-state with acknowledge suppression, 16
  - cyclic connection, 16
  - cyclic with acknowledge suppression, 16

- polled connection, 15
  - strobe connection, 15
- INTERBUS gateway, 55
- internal DeviceNet slave
  - configuration, 46
  - I/O connection, 30
  - limitations, 30
- internal slave device
  - predefined internal slave device, 29
- Internal slave device, 13

## L

- LED, 47
  - common LEDs, 47
  - DeviceNet Rx, 48
  - DeviceNet Tx, 48
  - module status, 47
  - network status, 48
  - specific LEDs, 47
  - test run, 49

## Limitation

- I/O devices, 32

## N

- network security, 12

## P

- predefined device template, 43
- predefined network, 29, 31

## Q

- queue tracking unit, 62

## R

- repeaters, 26

## S

- safety, 11
- shield grounding, 21
- system parameters
  - Connection Input Size, 109
  - Connection Output Size, 108
  - Connection Type, 97, 106
  - DeviceNet Address, 99, 101
  - DeviceNet Communication Speed, 100
  - Device Type, 104
  - Path, 113
  - Poll Rate, 107
  - Product Code, 103
  - Production Inhibit Time, 105
  - Quick Connect, 110
  - Service, 115
  - Vendor ID, 102

## T

- T-connector, 24
- template I/O configuration file, 32
- termination resistor, 23, 26
- topic I/O System, 29
  - Device, 97
  - DeviceNet Command, 98
  - device template, 31
  - Industrial Network, 29, 97
- trouble shooting, bus off, 117
- trunk line, 24
  - extending the length, 26







# Contact us

ABB AB  
Discrete Automation and Motion  
Robotics  
S-721 68 VÄSTERÅS, Sweden  
Telephone +46 (0) 21 344 400

ABB AS, Robotics  
Discrete Automation and Motion  
Nordlysvegen 7, N-4340 BRYNE, Norway  
Box 265, N-4349 BRYNE, Norway  
Telephone: +47 51489000

ABB Engineering (Shanghai) Ltd.  
5 Lane 369, ChuangYe Road  
KangQiao Town, PuDong District  
SHANGHAI 201319, China  
Telephone: +86 21 6105 6666

[www.abb.com/robotics](http://www.abb.com/robotics)