

SPAJ 141 C

Overcurrent and earth-fault relay

User's manual and Technical description

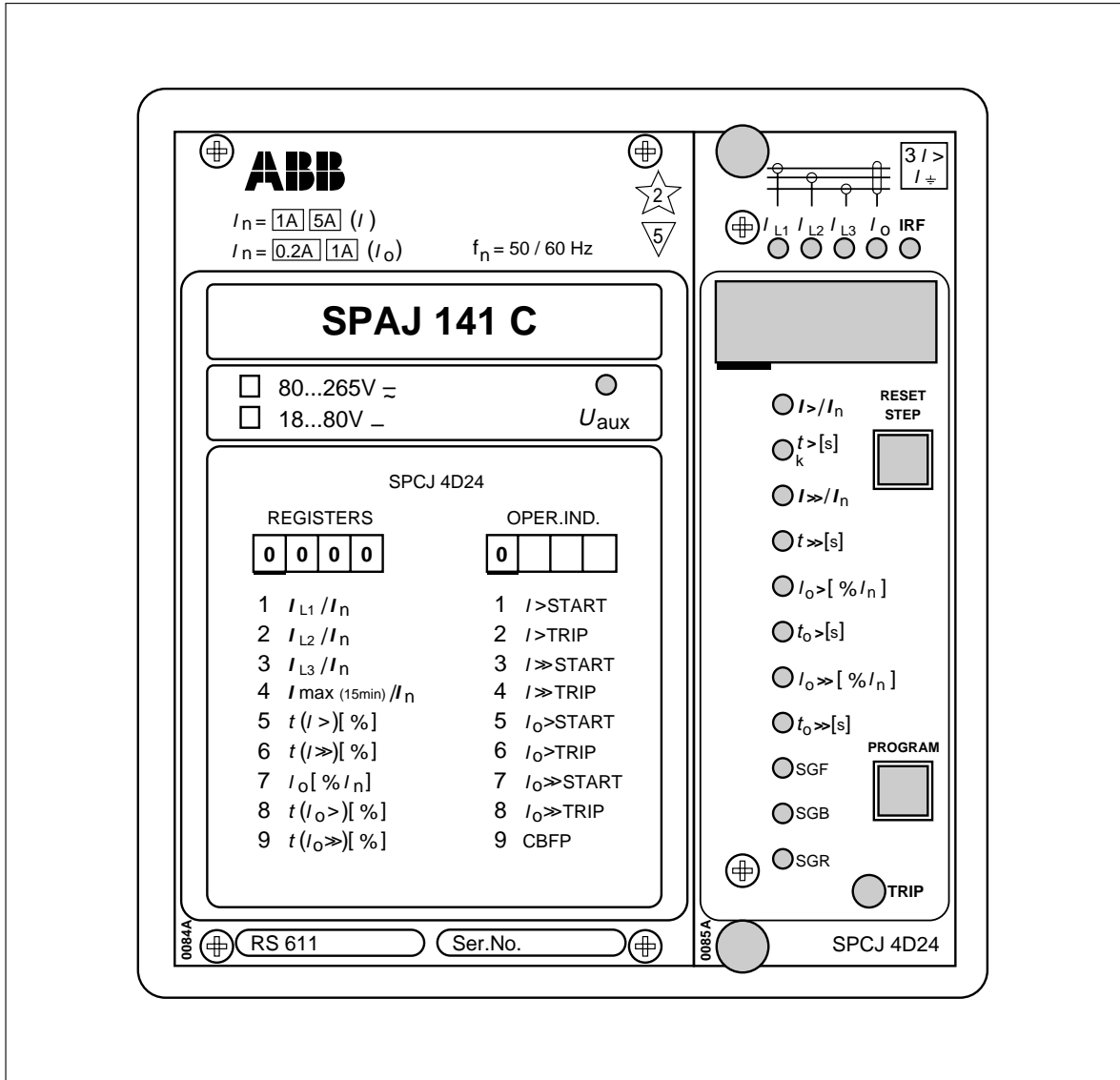

SPAJ 141 C

Combined overcurrent and earth-fault relay

Data subject to change without notice

Contents	Characteristics	2
	Application	2
	Description of operation	3
	Connection diagram	4
	Connections	6
	Control signals between the modules	7
	Signal abbreviations used	7
	Operation indicators	8
	Power supply and output relay module	9
	Technical data (<i>modified 2002-04</i>)	10
	Maintenance and repairs	13
	Spare parts	13
	Dimensions and instructions for mounting	14
	Ordering information	15

The complete manual for the relay SPAJ 141 C contains the following partial manuals:

General relay description	1MRS 750872-MUM EN
General characteristics of D-type relay modules	1MRS 750066-MUM EN
Combined overcurrent and earth-fault module SPCJ 4D24	1MRS 750121-MUM EN

Characteristics	<p>Three-phase low-set overcurrent unit with definite time or inverse definite minimum time (IDMT) characteristic.</p> <p>Three-phase high-set overcurrent unit with instantaneous or definite time function.</p> <p>Low-set sensitive, non-directional earth-fault protection with definite time characteristic.</p> <p>High-set non-directional earth-fault protection with instantaneous or definite time function.</p> <p>Built-in breaker failure protection scheme.</p>	<p>Fully field-selectable output relay configuration.</p> <p>Extensive data communication capabilities over built-in serial port.</p> <p>Outstanding design flexibility for easy selection of appropriate operation schemes for various applications.</p> <p>Numerical display of setting values, current measured values, memorized fault values etc.</p> <p>Continuous self-supervision with auto-diagnosis of internal faults.</p>
------------------------	---	---

Application	<p>The combined overcurrent and earth-fault relay SPAJ 141 C is intended to be used for the selective short-circuit and earth-fault protection of radial feeders in resistance earthed or impedance earthed power systems. The integrated protective relay comprises both an overcurrent unit and an earth-fault unit with highly flexible tripping</p>	<p>and signalling facilities. The feeder protection can be used in applications requiring a single-, two- or three-phase overcurrent protection and a non-directional earth-fault protection. The overcurrent and earth-fault relay also comprises a circuit breaker failure protection.</p>
--------------------	---	--

Description of operation

The combined overcurrent and earth-fault relay is a secondary relay device to be connected to the current transformers of the feeder to be protected. The three-phase overcurrent unit and the non-directional earth-fault unit continuously measure the phase currents and the neutral current of the protected feeder. In fault situations these units initiate external auto-reclose functions or trip the circuit-breaker, depending on the selected protective scheme.

When a phase current exceeds the starting value of the low-set overcurrent unit, the unit starts, simultaneously starting the corresponding timing circuit. When the set operating time has elapsed, a circuit-breaker tripping command is delivered. Correspondingly, the high-set stage of the overcurrent unit starts when its starting value is exceeded, starting its timing circuit and performing a tripping when the set time has elapsed.

The low-set stage of the non-directional earth-fault unit operates in the same way. Depending on the protective scheme it either signals, performs a tripping or initiates a function of an external auto-reclose relay. The input circuit comprises a low-pass filter, which reduces the amount of harmonics in the neutral current before the signal is measured.

The low-set stage of the overcurrent unit may be given definite time or inverse definite minimum time (IDMT) characteristics. When the IDMT characteristic is to be chosen six curve types are available in the relay. Four of the curves types comply with BS 142 and IEC 60255 and are named normal inverse, very inverse, extremely inverse and long-time inverse. The two additional curves are named the RI curve and the RXIDG curve. The low-set stage of the earth-fault unit is operating on a definite time basis.

By appropriate programming of the tripping relay matrix, the starting signals of the overcurrent and non-directional earth-fault modules are received as contact functions. This contact information is used e.g. for the blocking of co-operating protective relays located upstreams.

The relay comprises one external logic control input, which is actuated by a control signal of the auxiliary voltage level. The influence on the relay by the control input is determined by programming switches in the measuring module. The control input can be used either for blocking one or more of the protective stages, for resetting a latched output relay in the manual reset mode or for selecting a new group of relay settings by remote control.

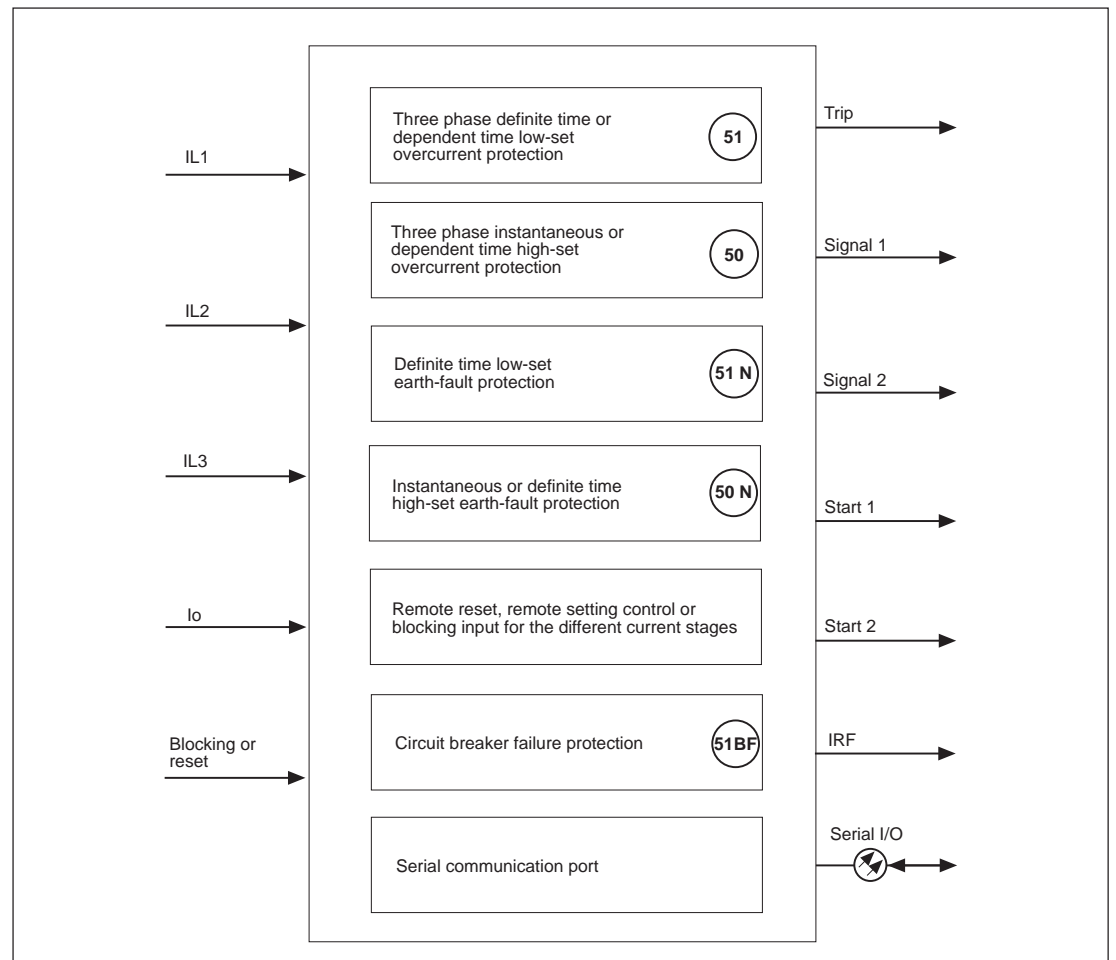

Fig. 1. Protective functions of the overcurrent and earth-fault relay SPAJ 141 C.

Connection diagram

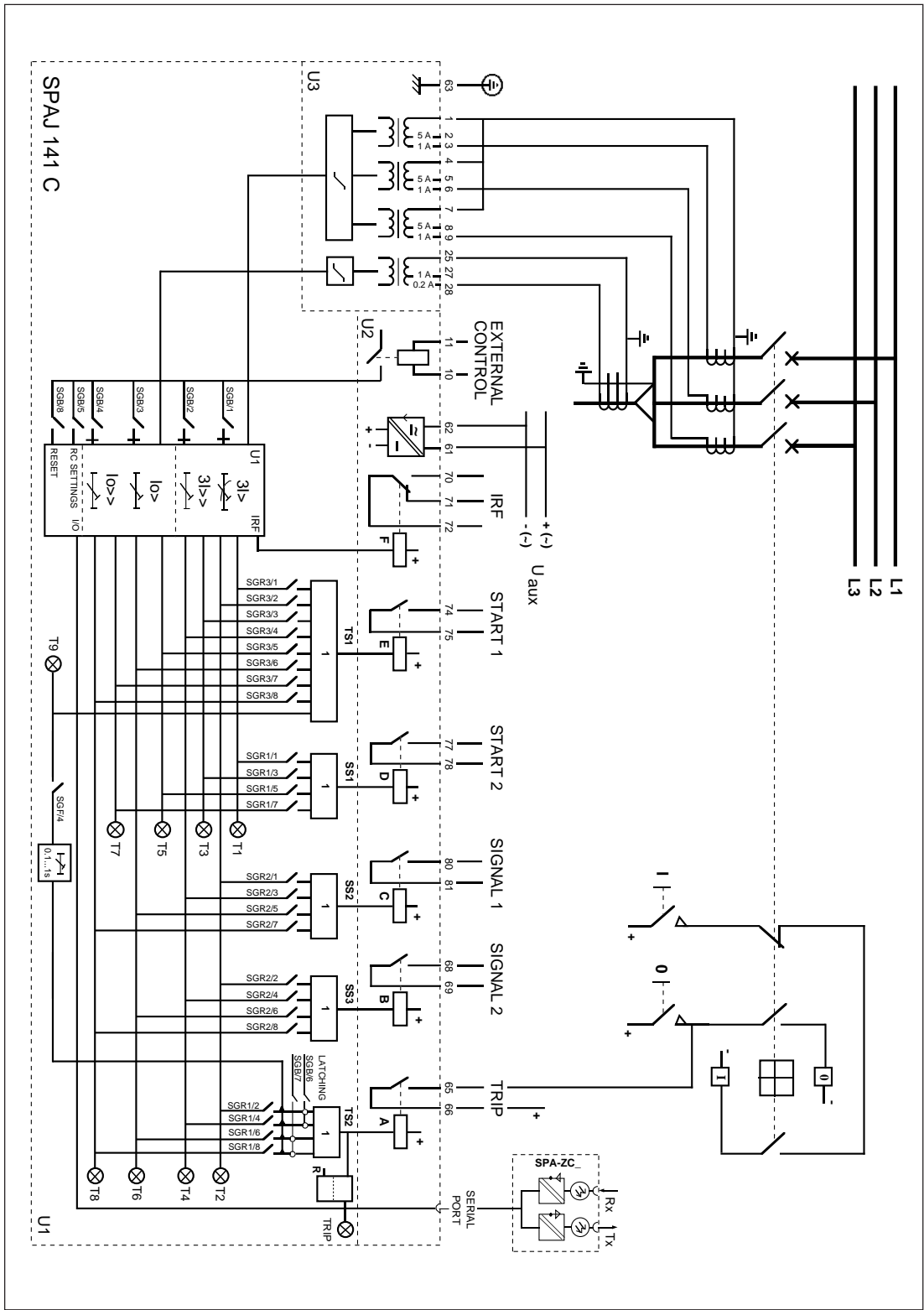

Fig. 2. Connection diagram for the combined overcurrent and earth-fault relay SPAJ 141 C with all the relay matrix switchgroups shown.

U_{aux}	Auxiliary voltage
A, B, C, D, E, F	Output relays
IRF	Self-supervision
SGR	Switchgroups for the configuration of trippings and signalings
SGB	Switchgroup for the configuration of the blocking or control signal
TRIP	Trip output relay
SIGNAL 1	Signal on overcurrent trip
SIGNAL 2	Signal on earth-fault trip
START 1	Starting or auxiliary trip signal as selected with switchgroup SGR3
START 2	Starting of overcurrent low-set stage I>
U1	Three-phase overcurrent and non-directional earth-fault module SPCJ 4D24
U3	Input module SPTE 4E2
U2	Power supply and output relay module SPTU 240 R1 or SPTU 48 R1
T1...T8	Starting and tripping indications
SERIAL PORT	Serial communication interface
SPA-ZC_	Bus connection module
Rx/Tx	Receiver bus terminal (Rx) and transmitter bus terminal (Tx) of the bus connection module

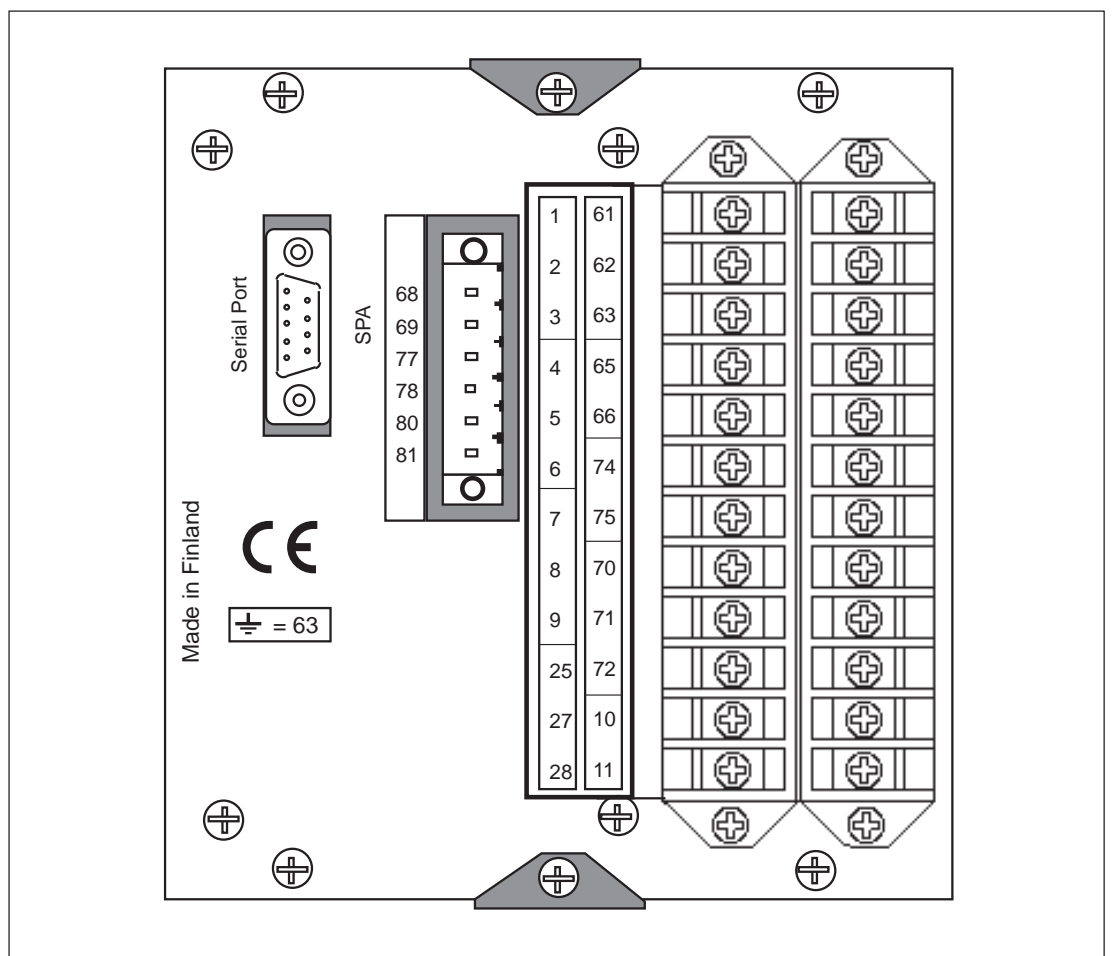

Fig. 3. Rear view of relay SPAJ 141 C.

Connections

The three phase-currents of the overcurrent protection are connected to terminals 1-2, 4-5 and 7-8, when the rated current of the secondary circuits is $I_n = 5 \text{ A}$. When using current transformers with a rated current of 1 A, terminals 1-3, 4-6 and 7-9 are used. The overcurrent protection may also be used in single-phase or two-phase applications, in which case inputs not to be used are left unconnected. In single-phase applications, however, wiring the phase current through two current inputs in series may increase the operating speed of the relay, particularly for instantaneous operations.

The neutral current of the earth-fault protection is connected to terminals 25-27 when the rated current is 1 A and to terminals 25-28 when the rated current is 0.2 A.

The control input 10-11 can be used in three different ways, as the control input of an external blocking signal for the measuring modules, as the control input for unlatching the trip relay, or as the control input for the remote control of settings. The function is selected by means of switches 1...8 of switchgroup SGB in the main menu of the measuring relay module.

The auxiliary supply voltage of the relay is connected to the terminals 61-62. At d.c. auxiliary supply voltage the positive lead is connected to terminal 61. The level of the voltage to be applied to the terminals is determined by the type of power supply and output relay module inserted in the protection. For further details see the description of the power supply module. The auxiliary voltage range of the relay has been marked on the front panel.

Output relay A provides the CB tripping commands so that the CB operates once the operating time of the low-set or high-set stage of the overcurrent or non-directional earth-fault module has elapsed. The stages to perform a tripping are selected with switches 2,4,6 and 8 of switchgroup SGR1. On delivery from factory all stages are selected to perform tripping. A latching function of the output relay A can be selected by means of switches SGB 6 and 7 for overcurrent and earth-fault trippings.

The trip alarm signals from the measuring modules are obtained through output relays B and C. The signals to be forwarded to the output relays B and C are selected with switches 1...8 of switchgroup SGR2 of the measuring module. The switch matrixes for configuration of

the control signals of the output relays B and C are identical. Normally the output relays B and C are given such a configuration that low-set and high-set overcurrent trip alarm signal is obtained over relay C and the corresponding alarm signal for the earth-fault trips via output relay B. This is also the default setting on delivery.

The starting signals from the protective stages of the relay are received through output relay D. The signals to be forwarded to the output relay D are selected by means of switches 1, 3, 5 and 7 of switchgroup SGR1 which is found in the main menu of the measuring module. The starting signals of the low-set and high-set stage of the overcurrent unit are selected with switches 1 and 3, whereas switches 5 and 7 convey the corresponding signals of the non-directional earth-fault unit.

Output relay E, terminals 74-75, is a heavy duty output relay capable of controlling a circuit breaker, like the main trip relay A. Relay E is used mainly for bringing out any starting or time delayed signal for starting of auto-reclosures, for signalling or counting purposes or for auxiliary trip. Output relay E is also used as a tripping output for the circuit breaker failure protection, CBFP when the CBFP function is used. In this case the trip signal can be used either to control a circuit breaker upstreams or to control a second trip coil on the main circuit breaker to give a higher redundancy to the breaker operation.

Output relay F, terminals 70-71-72, operates as the output relay of the self-supervision system of the relay. The relay operates on the closed-circuit principle so that in normal service conditions the contact gap 70-72 is closed. If a fault is detected by the self-supervision system, or if there is a failure in the auxiliary supply, the output relay drops off providing an alarm signal by closing the NO contact 71-72.

The relay is interfaced with a data transmission bus through a 9-pole, D-type subminiature connector located at the rear panel of the relay. By means of bus connection modules SPA-ZC 17 or SPA-ZC 21, the overcurrent and earth-fault relay can be linked to the fibre-optic bus. The terminals of the fibre-optic cables are connected to the counter terminals Rx and Tx of the bus connection module. The fibre-optic cables are linked from one protection to another and to the substation level communication unit, for instance type SRIO 1000M.

Control signals between the modules

The figure below schematically illustrates how the starting, tripping, control and blocking sig-

nals can be programmed to obtain the required function of the protection.

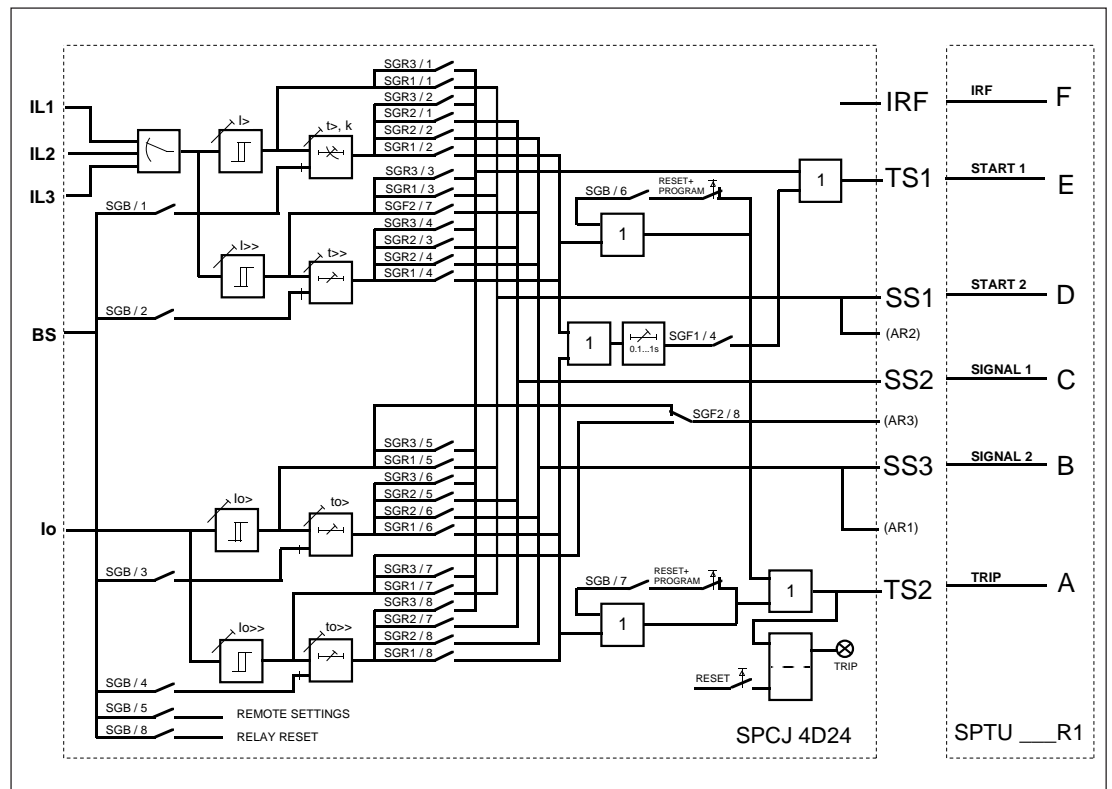

Fig. 4. Control signals between the modules of the overcurrent and earth-fault relay SPAJ 141 C.

The functions of the blocking and starting signals are selected with the switches of switch-groups SGF, SGB and SGR. The checksums of the switchgroups, are found in the setting menu

of the measuring relay module. The functions of the different switches are explained in the user's manual of the measuring module SPCJ 4D24.

Signal abbreviations used

I_{L1}, I_{L2}, I_{L3}	Phase currents to be measured
I_0	Neutral current
BS	Blocking or control Signal
SS1	Starting Signal 1
SS2	Starting Signal 2
SS3	Starting Signal 3
TS1	Tripping Signal 1
TS2	Tripping Signal 2
BS	Blocking Signal
AR1...3	Auto-Reclose starting signals (not in use in SPAJ 141 C)
IRF	Internal Relay Fault signal
SGF	Switch Group for Functions
SGB	Switch Group for Blockings
SGR	Switch Group for Relay configuration
IRF	Internal Relay Fault
Rx/Tx	Receiver/Transmitter channel

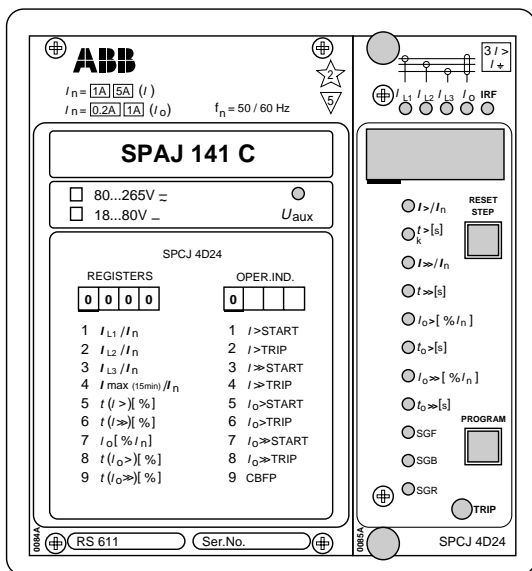

A) The indicator TRIP is lit when one of the protective stages operate. When the protective stage resets, the red indicator remains lit.

B) If the display is dark when one of the protective stages I>, I>>, I0> or I0>> call for a tripping, the faulty phase or the neutral path is indicated with a yellow LED. If, for instance, the TRIP indicator glows red, and the indicators IL1 and IL2 at the same time are illuminated, overcurrent has occurred on phase L1 and L2.

C) Besides being a code number at data presentation, the leftmost red digit or the display serves as a visual operation indicator. An operation indicator is recognized by the fact that the red digit alone is switched on. The following table named OPERATION IND. on the relay front panel is a key to the function code numbers used.

Indication	Explanation
1	I> START = The low-set stage I> of the overcurrent unit has started
2	I> TRIP = The low-set stage I> of the overcurrent unit has tripped
3	I>> START = The high-set stage I>> of the overcurrent unit has started
4	I>> TRIP = The high-set stage I>> of the overcurrent unit has tripped
5	I0> START = The low-set stage I0> of the earth-fault unit has started
6	I0> TRIP = The low-set stage I0> of the earth-fault unit has tripped
7	I0>> START = The high-set stage I0>> of the earth-fault unit has started
8	I0>> TRIP = The high-set stage I0>> of the earth-fault unit has tripped
9	CBFP = Circuit Breaker Failure Protection has operated

D) The TRIP indications persist when the protective stage returns to normal. The indicator is reset by pushing the RESET/STEP push-button.

Further, the indicators may be reset via the external control input 10-11 by applying a control voltage to the input, provided that the switch SGB/8 is in position 1.

The basic protective relay functions are not depending on the state of the operation indicators, reset or non-reset. The relay is permanently operative.

If a protective stage starts, but no tripping occurs because the energizing quantity goes below the starting level before the delay circuit times out, the starting indicators are normally automatically switched off. However, by means of the switches SGF2/1...4 the starting indications may be made persistent which means that they are to be reset by pushing the RESET/STEP push-button.

The persistent indications are obtained through the following programming.

Switch SGF2/1 = 1

Starting indication on I> persistent

Switch SGF2/2 = 1

Starting indication on I>> persistent

Switch SGF2/3 = 1

Starting indication on I0> persistent

Switch SGF2/4 = 1

Starting indication on I0>> persistent

On delivery from the factory the switches SGF2/1...4 have the preset configuration 0.

E) Shortly after the internal self-supervision system has detected a permanent relay fault the red IRF indicator is switched on and the output relay of the self-supervision system operates. Further, in most fault situations a autodiagnostic fault code is shown in the display. The fault code is composed of a red figure 1 and a green code number which indicates what may be the fault type. The fault code persists until the STEP/RESET button is pressed. When a fault code appears on the display, the code number should be recorded and stated when service is ordered.

Power supply and output relay module

To be able to operate the relay needs a secured auxiliary voltage supply. The power supply module forms the voltages required by the measuring relay module and the auxiliary relays. The withdrawable power supply and output relay module is located behind the system front panel, which is fixed by means of form cross-slotted screws. The power supply and output relay module contains the power supply unit, all output relays, the control circuits of the output relays and the electronic circuitry of the external control inputs.

The power supply and output relay module can be withdrawn after removing the system front

panel. The primary side of the power supply module is protected with a fuse, F1, located on the PCB of the module. The fuse size is 1 A (slow).

The power supply unit is a transformer connected, i.e. galvanically isolated primary and secondary side, flyback-type dc/dc converter. It forms the dc secondary voltages required by the measuring relay module; that is +24 V, ± 12 V and +8 V. The output voltages ± 12 V and +24 V are stabilized in the power supply module, while the +5 V logic voltage required by the measuring relay module is formed by the stabilizer of the relay module.

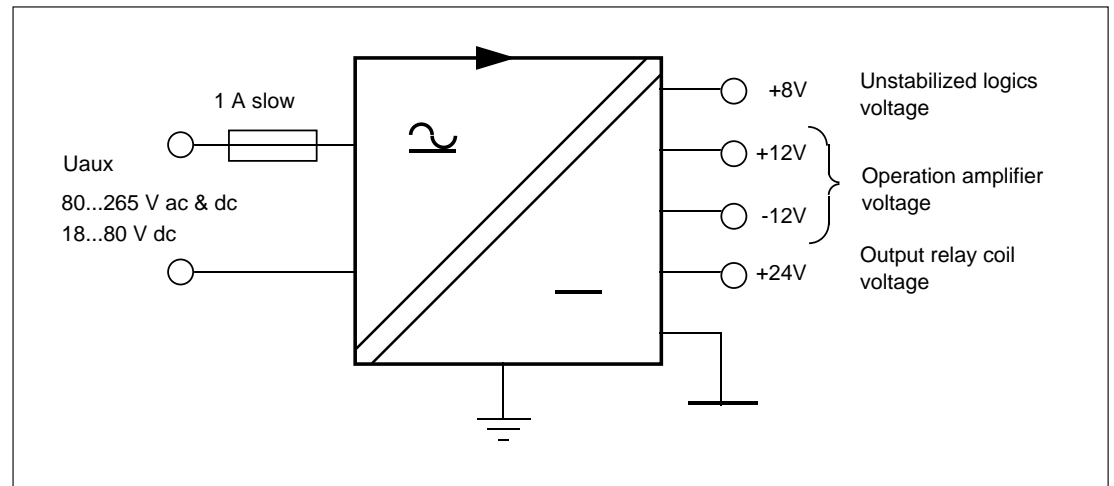

Fig. 5. Voltage levels of the power supply module.

A green LED indicator U_{aux} on the system front panel is illuminated when the power supply module is in operation. The supervision of the voltages supplying the electronics is placed in the measuring module. If a secondary voltage deviates from its rated value by more than 25 %, a selfsupervision alarm will be established. An alarm is also received when the power supply module is withdrawn from the relay case, or when the auxiliary power supply to the relay is interrupted.

There are two versions of power supply and output relay modules available. For both types, the secondary sides and the relay configurations are identical, but the input voltage ranges differ.

Insulation test voltage between the primary and secondary side and the protective earth
2 kV, 50 Hz, 1 min

Rated power P_n 5 W

Voltage ranges of the power supply modules:
- SPTU 240 R1 $U_{aux} = 80...265$ V dc/ac
- SPTU 48 R1 $U_{aux} = 18...80$ V dc
(on request)

The SPTU 240 R1 module can be used with both ac and dc voltages. SPTU 48 R1 is designed for dc supply only. The system front panel of the relay indicates the auxiliary voltage range of the power supply module of the relay assembly.

Technical data
(modified 2002-04)

Energizing inputs

Rated current I_n			
Overcurrent unit		1 A	5 A
Earth-fault unit	0.2 A	1 A	
Thermal withstand capability			
- continuously	2 A	4 A	20 A
- for 1 s	50 A	100 A	500 A
Dynamic current withstand, half-wave value	100 A	250 A	1250 A
Input impedance	<750 m Ω	<100 m Ω	<20 m Ω
Rated frequency f_n	50 Hz		
Rated frequency on request	60 Hz		

Output contact ratings

Tripping contacts	
Terminals	65-66, 74-75
- Rated voltage	250 V dc/ac
- Carry continuously	5 A
- Make and carry for 0.5 s	30 A
- Make and carry for 3.0 s	15 A
- Breaking capacity for dc, when the control circuit time-constant L/R < 40 ms, at 48 / 110 / 220 V dc	5 A / 3 A / 1 A

Signalling contacts

Terminals	70-71-72, 68-69, 77-78, 80-81
- Rated voltage	250 V dc/ac
- Rated current	5 A
- Make and carry for 0.5 s	10 A
- Make and carry for 3.0 s	8 A
- Breaking capacity for dc, when the control circuit time-constant L/R < 40 ms, at 48 / 110 / 220 V dc control circuit voltage	1 A / 0.25 A / 0.15 A

External control inputs

Blocking, remote reset or remote setting input	10-11
External control voltage level	18...265 V dc or 80...265 V ac
Typical control current of input circuit	2...20 mA

Power supply and output relay module

Supply and relay module, type SPTU 240 R1	80...265 V dc/ac
Supply and relay module, type SPTU 48 R1	18...80 V dc (on request)
Power consumption under quiescent/ operating conditions	4 W/ 6 W

Overcurrent unit of SPCJ 4D24

Low-set overcurrent stage I>	
Setting range	0.5...5.0 x I _n
Selectable modes of operation	
- definite time operation	
- operating time t>	0.05...300 s
- inverse definite minimum time (IDMT) mode of operation as per IEC 60255-3 and BS 142	Extremely inverse Very inverse Normal inverse Long-time inverse
- special type inverse characteristics	RI-type inverse RXIDG-type inverse
- time multiplier k	0.05...1.0
High-set overcurrent stage I>>	
Setting range	0.5...40 x I _n and ∞
Operating time t>>	0.04...300 s

Note!

If the setting is higher than 2.5 x I_n, the maximum continuous carry (4 x I_n) and the levelling out of the IDMT-curves at high current levels must be noted.

Note!

The high-current end of any inverse time characteristic is determined by the high-set stage which, when started, inhibits the low-set stage operation. The trip time is thus equal to the set t>> for any current higher than I>>. In order to get a trip signal, the stage I>> must also of course be linked to a trip output relay.

Earth-fault unit of SPCJ 4D24

Low-set neutral overcurrent stage I ₀ >	
Setting range	1.0...25.0 % I _n
Selectable modes of operation	
- definite time operation	
- operating time t ₀ >	0.05...300 s
High-set neutral overcurrent stage I ₀ >>	
Setting range	2...200 % I _n and ∞
Operating time t ₀ >>	0.05... 300 s

Data transmission

Transmission mode	Fibre optic serial bus
Data code	ASCII
Selectable data transfer rates	4800 or 9600 Bd

Fibre optic bus connection modules with integral power unit

- for plastic core cables SPA-ZC 17 BB
- for glass fibre cables SPA-ZC 17 MM

Fibre optic bus connection modules which are powered from the host relay

- for plastic core cables SPA-ZC 21 BB
- for glass fibre cables SPA-ZC 21 MM

Insulation Tests *)

Dielectric test IEC 60255-5	2 kV, 50 Hz, 1 min
Impulse voltage test IEC 60255-5	5 kV, 1.2/50 μ s, 0.5 J
Insulation resistance measurement IEC 60255-5	>100 M Ω , 500 Vdc

Electromagnetic Compatibility Tests *)

High-frequency (1 MHz) burst disturbance test IEC 60255-22-1	
- common mode	2.5 kV
- differential mode	1.0 kV
Electrostatic discharge test IEC 60255-22-2 and IEC 61000-4-2	
- contact discharge	6 kV
- air discharge	8 kV
Fast transient disturbance test IEC 60255-22-4 and IEC 61000-4-4	
- power supply	4 kV
- I/O ports	2 kV

Environmental conditions

Specified ambient service temperature range	-10...+55°C
Long term damp heat withstand according to IEC 60068-2-3	< 95 % at 40°C for 56 d
Transport and storage temperature range	-40...+70°C
Degree of protection by enclosure of the relay case as per IEC 60529 when panel mounted	IP 54
Mass of the relay, when flush mounted	3.5 kg

*) The tests do not apply to the serial port, which is used exclusively for the bus connection module.

Maintenance and repair

When the protective relay is operating under the conditions specified in the section "Technical data", the relay is practically maintenance-free. The relay modules include no parts or components subject to an abnormal physical or electrical wear under normal operating conditions.

If the environmental conditions at the relay operating site differ from those specified, as to temperature, humidity, or if the atmosphere around the relay contains chemically active gases or dust, the relay ought to be visually inspected in association with the relay secondary test or whenever the relay modules are withdrawn from the case. At the visual inspection the following things should be noted:

- Signs of mechanical damage on relay modules, contacts and relay case
- Accumulation of dust inside the relay cover or case; remove by blowing air carefully
- Rust spots or signs of erugo on terminals, case or inside the relay

On request, the relay can be given a special treatment for the protection of the printed circuit boards against stress on materials, caused by abnormal environmental conditions.

If the relay fails in operation or if the operating values remarkably differ from those of the relay specifications, the relay should be given a proper overhaul. Minor measures can be taken by personnel from the instrument work-shop of the customer's company, e.g. replacement of auxiliary relay modules. All major measures involving overhaul of the electronics are to be taken by the manufacturer. Please contact the manufacturer or his nearest representative for further information about checking, overhaul and recalibration of the relay.

Note!

Static protective relays are measuring instruments and should be handled with care and protected against moisture and mechanical stress, especially during transport.

Spare parts

Three-phase overcurrent and earth-fault module

SPCJ 4D24

Power supply and output relay module

$U_{aux} = 80...265 \text{ V ac/dc}$

$U_{aux} = 18...80 \text{ V dc}$

SPTU 240 R1

SPTU 48 R1

Input module

SPTE 4E2

Bus connection module

SPA-ZC 17__ or SPA-ZC 21__

Dimensions for mounting

The relay is housed in a normally flush-mounted case. The relay can also be arranged for semi-flush mounting with the use of a 40 mm, 80 mm or 120 mm raising frame, which reduces the depth behind the panel by the same dimension. The type designations of the raising frames are SPA-ZX 111 for the 40 mm frame, SPA-ZX 112 for the 80 mm frame and SPA-ZX 113 for the 120 mm frame. A surface mounting case SPA-ZX 110 is also available.

The relay case is made of profile aluminium and finished in beige.

A cast aluminium alloy mounting frame with a rubber gasket provides a degree of protection by enclosure to IP 54 between the relay case and the panel surface when the relay is panel mounted.

The relay case is complete with a hinged gasketed, clear, UV-stabilized polycarbonate cover with a sealable fastening screw. The degree of protection by enclosure of the cover is also IP 54.

A terminal strip and two multipole connectors are mounted on the back of the relay case to facilitate all input and output connections. To each heavy duty terminal, i.e. measuring input, power supply or trip output, one 6 mm², one 4 mm² or one or two 2.5 mm² wires can be connected. No terminal lugs are needed. The signalling outputs are available on a six pole detachable connector and the serial bus connection is using a 9-pin D-type connector.

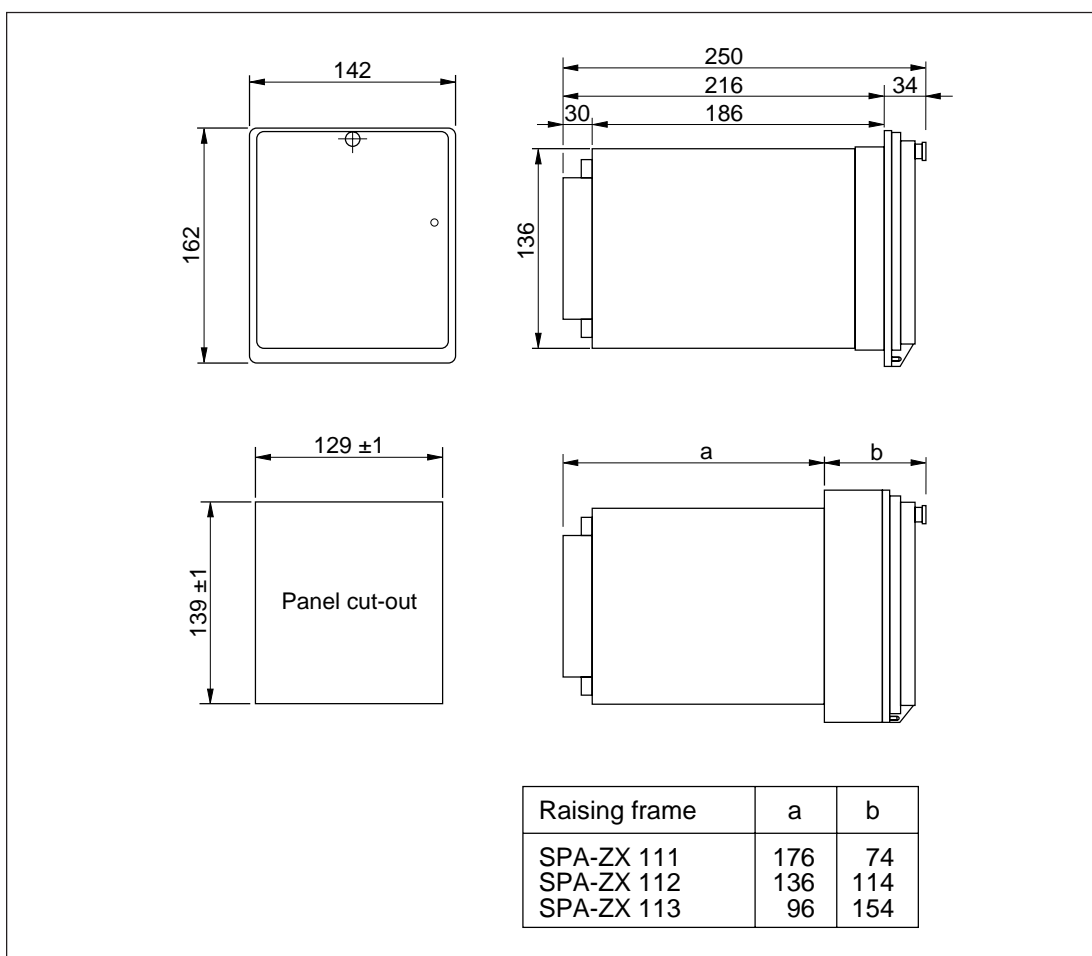

Ordering information

When ordering, please, state:

- | | |
|-------------------------|------------------------------|
| 1. Type designation | Example
SPAJ 141 C |
| 2. Rated frequency | $f_n = 50 \text{ Hz}$ |
| 3. Auxiliary supply | $U_{aux} = 110 \text{ V dc}$ |
| 4. Ordering number | RS 611 007 - AA |
| 5. Accessories | |
| - Bus connection module | SPA-ZC 21 BB |
| - Fibre-optic cable | SPA-ZF AA5, 2 pces |
| - Fibre-optic cable | SPA-ZF AA20, 5 pces |

Ordering numbers for SPAJ 141 C

Type designation	Name	Order number
SPAJ 141 C	Combined overcurrent and earth-fault relay	RS 611 007 - AA, -CA, -DA, -FA
SPAJ 141 C + RTXP 18	Combined overcurrent and earth-fault relay including a test socket RTXP 18 mounted on bars and prewired to the relay	RS 611 207 - AA, -CA, -DA, -FA

The two last letters of the ordering number designate the rated frequency f_n and the range of the auxiliary voltage U_{aux} of the relay as follows:

- AA equals $f_n = 50 \text{ Hz}$ and $U_{aux} = 80 \dots 265 \text{ V ac/dc}$
- CA equals $f_n = 50 \text{ Hz}$ and $U_{aux} = 18 \dots 80 \text{ V dc}$
- DA equals $f_n = 60 \text{ Hz}$ and $U_{aux} = 80 \dots 265 \text{ V ac/dc}$
- FA equals $f_n = 60 \text{ Hz}$ and $U_{aux} = 18 \dots 80 \text{ V dc}$

General characteristics of D-type relay modules

User's manual and Technical description

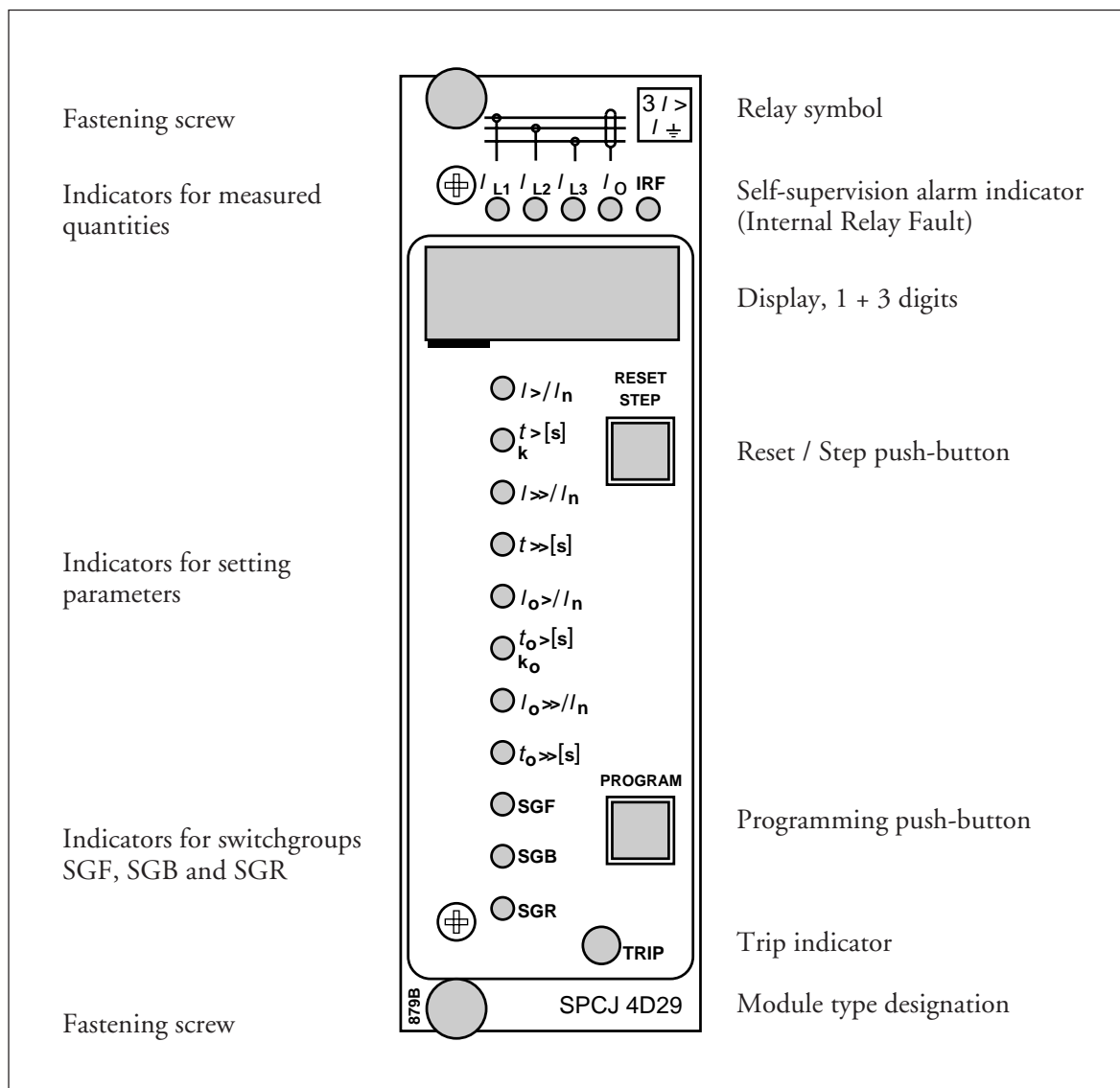

General characteristics of D type relay modules

Data subject to change without notice

Contents

Front panel lay-out	1
Control push buttons	3
Display	3
Display main menu	3
Display submenus	3
Selector switchgroups SGF, SGB, SGR	4
Settings	4
Setting mode	4
Example 1: Setting of relay operation values	7
Example 2: Setting of relay switchgroups	9
Recorded information	11
Trip test function	12
Example 3: Forced activation of outputs	13
Operation indicators	15
Fault codes	15

Control push-buttons	The front panel of the relay module contains two push buttons. The RESET / STEP push button is used for resetting operation indicators and for stepping forward or backward in the display main menu or submenus. The PROGRAM push button is used for moving from a	certain position in the main menu to the corresponding submenu, for entering the setting mode of a certain parameter and together with the STEP push button for storing the set values. The different operations are described in the subsequent paragraphs in this manual.
Display	The measured and set values and the recorded data are shown on the display of the protection relay module. The display consists of four digits. The three green digits to the right show the measured, set or recorded value and the leftmost red digit shows the code number of the register. The measured or set value displayed is indicated by the adjacent yellow LED indicator on the front panel. When a recorded fault value is being displayed the red digit shows the number of the corresponding register. When the display functions as an operation indicator the red digit alone is shown.	When the auxiliary voltage of a protection relay module is switched on the module initially tests the display by stepping through all the segments of the display for about 15 seconds. At first the corresponding segments of all digits are lit one by one clockwise, including the decimal points. Then the center segment of each digit is lit one by one. The complete sequence is carried out twice. When the test is finished the display turns dark. The testing can be interrupted by pressing the STEP push button. The protection functions of the relay module are alerted throughout the testing.
Display main menu	<p>Any data required during normal operation are accessible in the main menu i.e. present measured values, present setting values and recorded parameter values.</p> <p>The data to be shown in the main menu are sequentially called up for display by means of the STEP push button. When the STEP push button is pressed for about one second, the display moves forward in the display sequence. When the push button is pressed for about 0.5 seconds, the display moves backward in the display sequence.</p>	<p>From a dark display only forward movement is possible. When the STEP push button is pushed constantly, the display continuously moves forward stopping for a while in the dark position.</p> <p>Unless the display is switched off by stepping to the dark point, it remains lit for about 5 minutes from the moment the STEP push button was last pushed. After the 5 minutes' time-out the display is switched off.</p>
Display submenus	<p>Less important values and values not very often set are displayed in the submenus. The number of submenus varies with different relay module types. The submenus are presented in the description of the concerned protection relay module.</p> <p>A submenu is entered from the main menu by pressing the PROGRAM push button for about one second. When the push button is released, the red digit of the display starts flashing, indicating that a submenu has been entered. Going from one submenu to another or back to the main menu follows the same principle as when moving from the main menu display to another;</p>	<p>the display moves forward when the STEP push button is pushed for one second and backward when it is pushed for 0.5 seconds. The main menu has been re-entered when the red display turns dark.</p> <p>When a submenu is entered from a main menu of a measured or set value indicated by a LED indicator, the indicator remains lit and the address window of the display starts flashing. A submenu position is indicated by a flashing red address number alone on the display without any lit set value LED indicator on the front panel.</p>

Selector switch-groups SGF, SGB and SGR

Part of the settings and the selections of the operation characteristic of the relay modules in various applications are made with the selector switchgroups SG_. The switchgroups are software based and thus not physically to be found in the hardware of the relay module. The indicator of the switchgroup is lit when the checksum of the switchgroup is shown on the display. Starting from the displayed checksum and by entering the setting mode, the switches can be set one by one as if they were real physical switches. At the end of the setting procedure, a checksum for the whole switchgroup is shown. The checksum can be used for verifying that the switches have been properly set. Fig. 2 shows an example of a manual checksum calculation.

When the checksum calculated according to the example equals the checksum indicated on the display of the relay module, the switches in the concerned switchgroup are properly set.

Switch No	Pos.		Weight	Value
1	1	x	1	= 1
2	0	x	2	= 0
3	1	x	4	= 4
4	1	x	8	= 8
5	1	x	16	= 16
6	0	x	32	= 0
7	1	x	64	= 64
8	0	x	128	= 0
Checksum			Σ	= 93

Fig. 2. Example of calculating the checksum of a selector switchgroup SG_.

The functions of the selector switches of the different protection relay modules are described in detail in the manuals of the different relay modules.

Settings

Most of the start values and operate times are set by means of the display and the push buttons on the front panel of the relay modules. Each setting has its related indicator which is lit when the concerned setting value is shown on the display.

In addition to the main stack of setting values most D type relay modules allow a second stack of settings. Switching between the main settings

and the second settings can be done in three different ways:

- 1) By command V150 over the serial communication bus
- 2) By an external control signal BS1, BS2 or RRES (BS3)
- 3) Via the push-buttons of the relay module, see submenu 4 of register A.

Setting mode

Generally, when a large number of settings is to be altered, e.g. during commissioning of relay systems, it is recommended that the relay settings are entered with the keyboard of a personal computer provided with the necessary software. When no computer nor software is available or when only a few setting values need to be altered the procedure described below is used.

The registers of the main menu and the submenus contain all parameters that can be set. The settings are made in the so called setting mode, which is accessible from the main menu or a submenu by pressing the PROGRAM push button, until the whole display starts flashing. This position indicates the value of the parameter before it has been altered. By pressing the PROGRAM push button the programming sequence moves forward one step. First the rightmost digit starts flashing while the rest of the display is steady. The flashing digit is set by means of the STEP push button. The flashing

cursor is moved on from digit to digit by pressing the PROGRAM push button and in each stop the setting is performed with the STEP push button. After the parameter values have been set, the decimal point is put in place. At the end the position with the whole display flashing is reached again and the data is ready to be stored.

A set value is recorded in the memory by pressing the push buttons STEP and PROGRAM simultaneously. Until the new value has been recorded a return from the setting mode will have no effect on the setting and the former value will still be valid. Furthermore *any attempt to make a setting outside the permitted limits for a particular parameter will cause the new value to be disqualified and the former value will be maintained.* Return from the setting mode to the main menu or a submenu is possible by pressing the PROGRAM push button until the green digits on the display stop flashing.

NOTE! During any local man-machine communication over the push buttons and the display on the front panel a five minute time-out function is active. Thus, if no push button has been pressed during the last five minutes, the relay returns to its normal state automatically. This means that the display turns dark, the relay escapes from a display mode, a programming routine or any routine going on, when the relay is left untouched. This is a convenient way out of any situation when the user does not know what to do.

Before a relay module is inserted into the relay case, one must assure that the module has been given the correct settings. If there however is

any doubt about the settings of the module to be inserted, the setting values should be read using a spare relay unit or with the relay trip circuits disconnected. If this cannot be done the relay can be set into a non-tripping mode by pressing the PROGRAM push button and powering up the relay module simultaneously. The display will show three dashes "---" to indicate the non-tripping mode. The serial communication is operative and all main and submenus are accessible. In the non-tripping mode unnecessary trippings are avoided and the settings can be checked. *The normal protection relay mode is entered automatically after a timeout of five minutes or ten seconds after the dark display position of the main menu has been entered.*

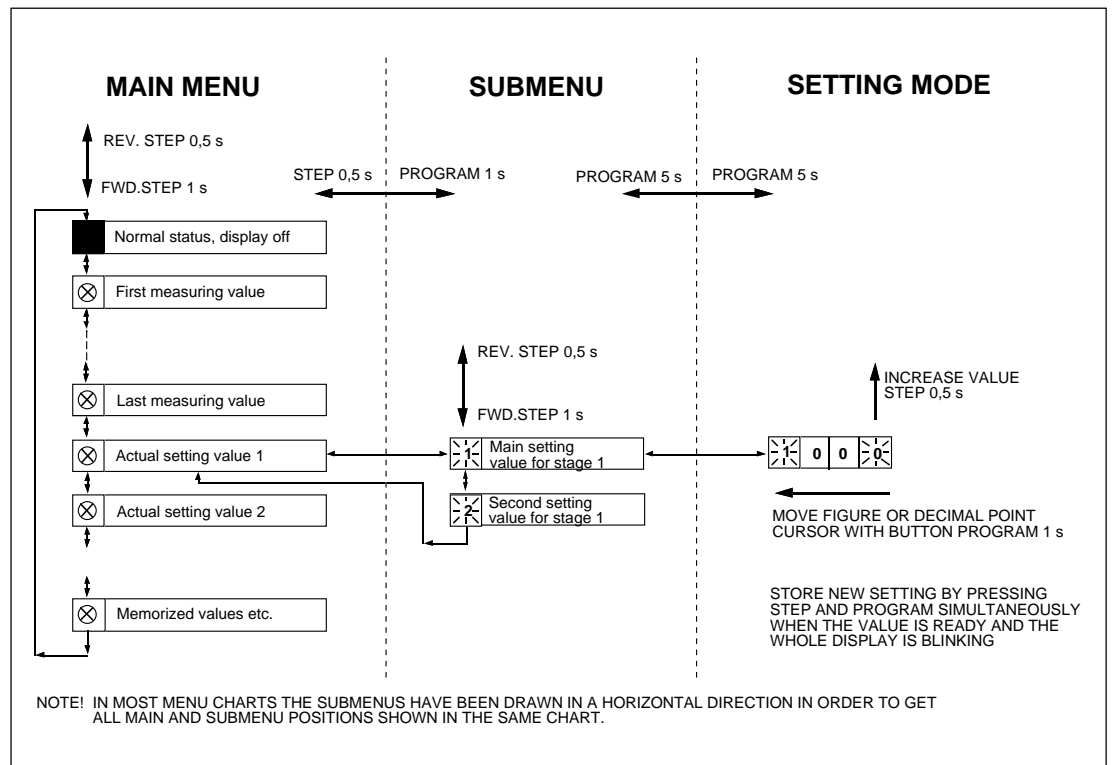

Fig.3. Basic principles of entering the main menus and submenus of a relay module.

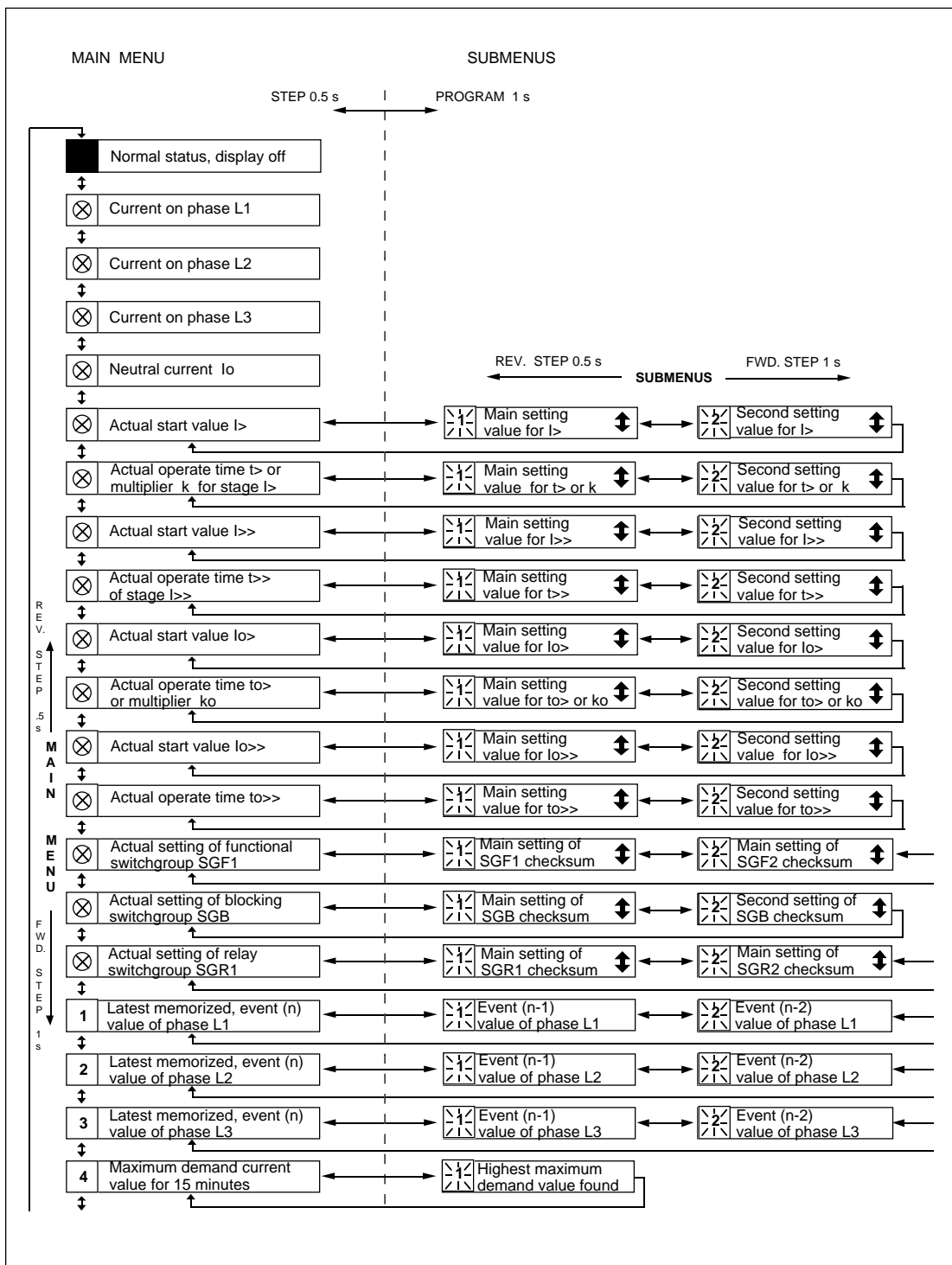

Fig. 4. Example of part of the main and submenus for the settings of the overcurrent and earth-fault relay module SPCJ 4D29. The settings currently in use are in the main menu and they are displayed by pressing the STEP push button. The main menu also includes the measured current values, the registers 1...9, 0 and A. The main and second setting values are located in the submenus and are called up on the display with the PROGRAM push button.

Example 1

Operation in the setting mode. Manual setting of the main setting of the start current value $I>$ of an overcurrent relay module. The initial value

for the main setting is $0.80 \times I_n$ and for the second setting $1.00 \times I_n$. The desired main start value is $1.05 \times I_n$.

a) Press push button STEP repeatedly until the LED close to the $I>$ symbol is lit and the current start value appears on the display.

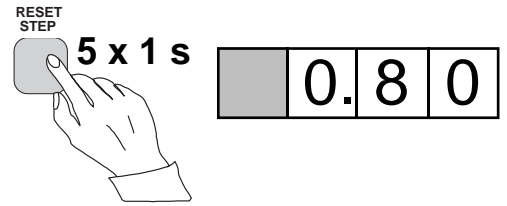

b) Enter the submenu to get the main setting value by pressing the PROGRAM push button more than one second and then releasing it. The red display digit now shows a flashing number 1, indicating the first submenu position and the green digits show the set value.

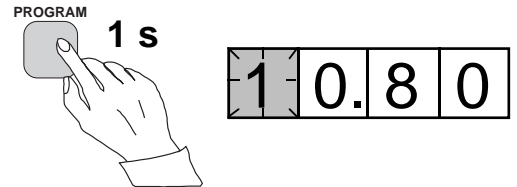

c) Enter the setting mode by pressing the PROGRAM push button for five seconds until the display starts flashing.

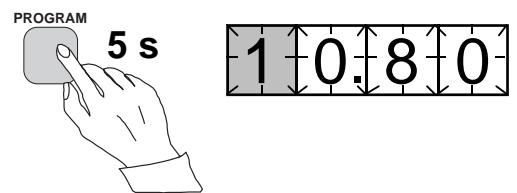

d) Press the PROGRAM push button once again for one second to get the rightmost digit flashing.

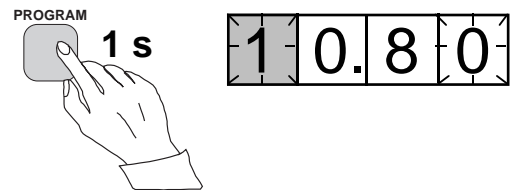

e) Now the flashing digit can be altered. Use the STEP push button to set the digit to the desired value.

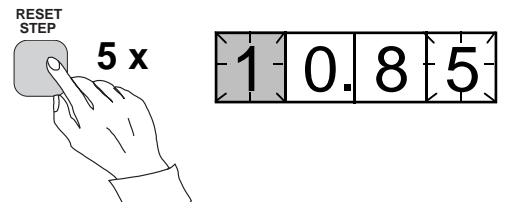

f) Press the PROGRAM push button to make the middle one of the green digits flash.

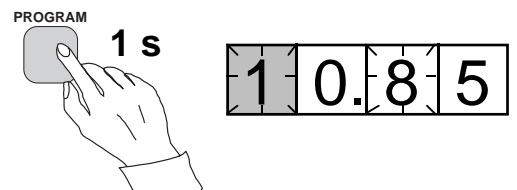

g) Set the middle digit with of the STEP push button.

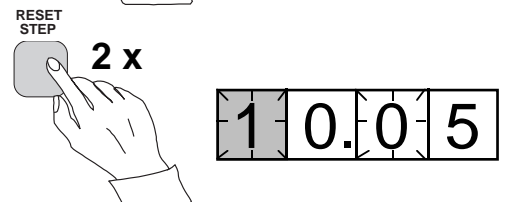

h) Press the PROGRAM push button to make the leftmost green digit flash.

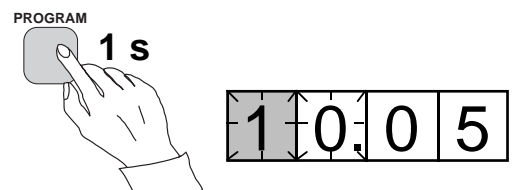

i) Set the digit with the STEP push button.

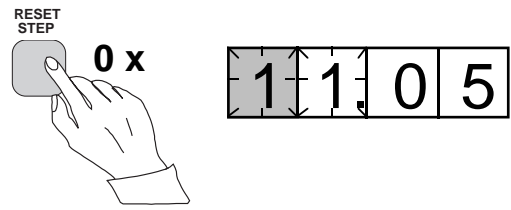

j) Press the PROGRAM push button to make the decimal point flash.

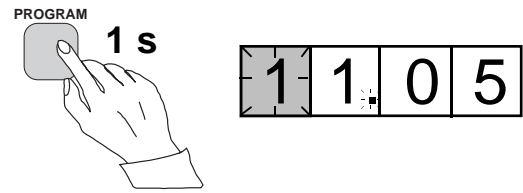

k) If needed, move the decimal point with the STEP push button.

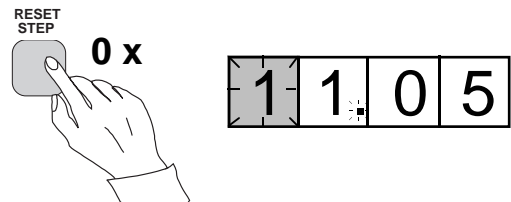

l) Press the PROGRAM push button to make the whole display flash. In this position, corresponding to position c) above, one can see the new value before it is recorded. If the value needs changing, use the PROGRAM push button to alter the value.

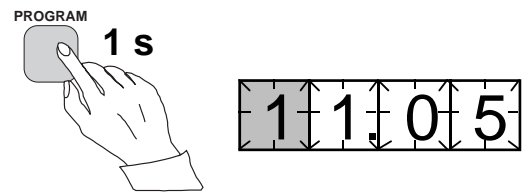

m) When the new value has been corrected, record it in the memory of the relay module by pressing the PROGRAM and STEP push buttons simultaneously. At the moment the information enters the memory, the green dashes flash once in the display, i.e. 1 - - -.

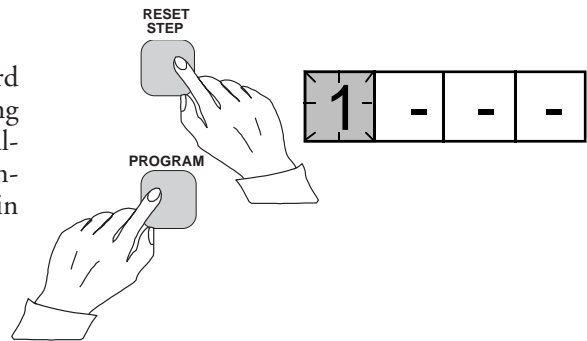

n) Recording of the new value automatically initiates a return from the setting mode to the normal submenu. Without recording one can leave the setting mode any time by pressing the PROGRAM push button for about five seconds, until the green display digits stop flashing.

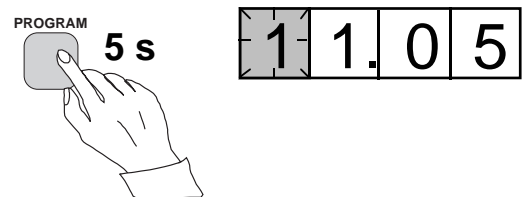

o) If the second setting is to be altered, enter submenu position 2 of the setting I> by pressing the STEP push button for approx. one second. The flashing position indicator 1 will then be replaced by a flashing number 2 which indicates that the setting shown on the display is the second setting for I>.

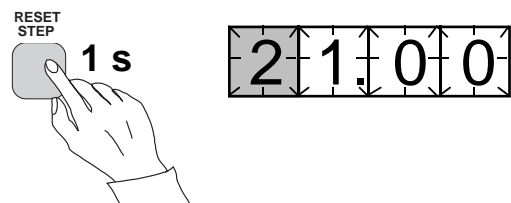

Enter the setting mode as in step c) and proceed in the same way. After recording of the requested values return to the main menu is obtained by pressing the STEP push button

until the first digit is switched off. The LED still shows that one is in the I> position and the display shows the new setting value currently in use by the relay module.

Example 2

Operation in the setting mode. Manual setting of the main setting of the checksum for the switchgroup SGF1 of a relay module. The initial value for the checksum is 000 and the switches

SGF1/1 and SGF1/3 are to be set in position 1. This means that a checksum of 005 should be the final result.

a) Press push button STEP until the LED close to the SGF symbol is lit and the checksum appears on the display.

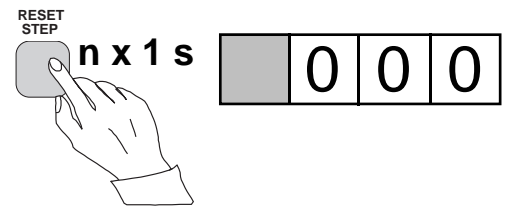

b) Enter the submenu to get the main checksum of SGF1 by pressing the PROGRAM push button for more than one second and then releasing it. The red display now shows a flashing number 1 indicating the first submenu position and the green digits show the checksum.

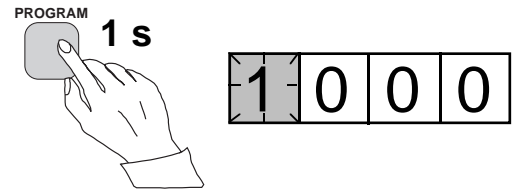

c) Enter the setting mode by pressing the PROGRAM push button for five seconds until the display starts flashing.

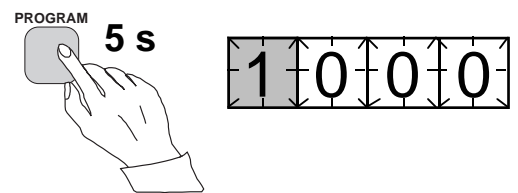

d) Press the PROGRAM push button once again to get the first switch position. The first digit of the display now shows the switch number. The position of the switch is shown by the rightmost digit.

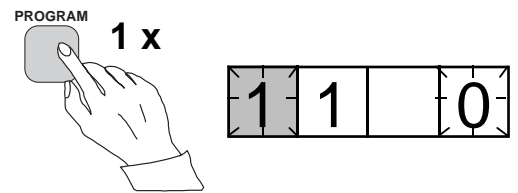

e) The switch position can now be toggled between 1 and 0 by means of the STEP push button and it is left in the requested position 1.

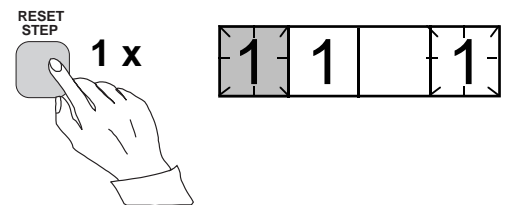

f) When switch number 1 is in the requested position, switch number 2 is called up by pressing the PROGRAM push button for one second. As in step e), the switch position can be altered by using the STEP push button. As the desired setting for SGF1/2 is 0 the switch is left in the 0 position.

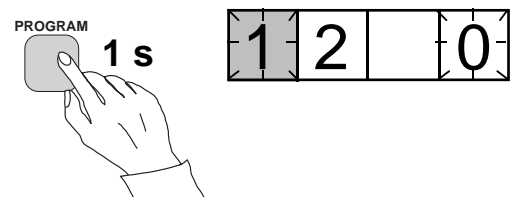

g) Switch SGF1/3 is called up as in step f) by pressing the PROGRAM push button for about one second.

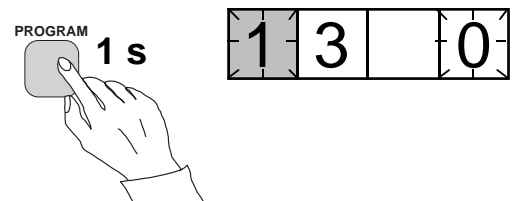

h)
The switch position is altered to the desired position 1 by pressing the STEP push button once.

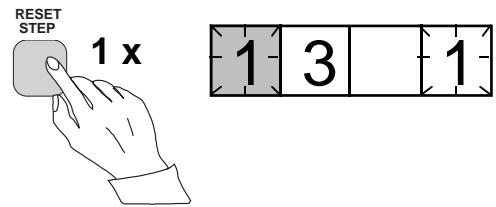

i)
Using the same procedure the switches SGF 1/4...8 are called up and, according to the example, left in position 0.

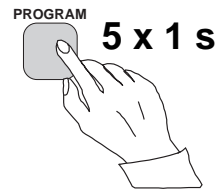

j)
In the final setting mode position, corresponding to step c), the checksum based on the set switch positions is shown.

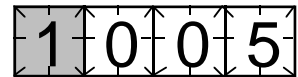

k)
If the correct checksum has been obtained, it is recorded in the memory by pressing the push buttons PROGRAM and STEP simultaneously. At the moment the information enters the memory, the green dashes flash in the display, i.e. 1 - - -. If the checksum is incorrect, the setting of the separate switches is repeated using the PROGRAM and STEP push buttons starting from step d).

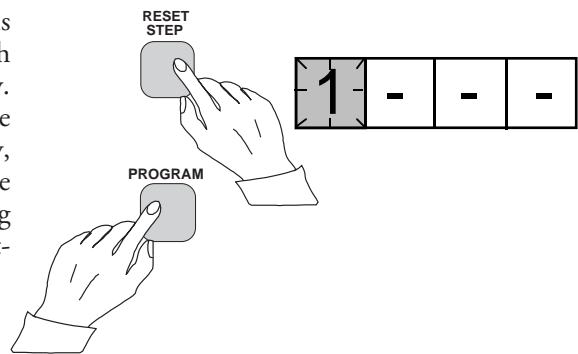

l)
Recording the new value automatically initiates a return from the setting mode to the normal menu. Without recording one can leave the setting mode any time by pressing the PROGRAM push button for about five seconds, until the green display digits stop flashing.

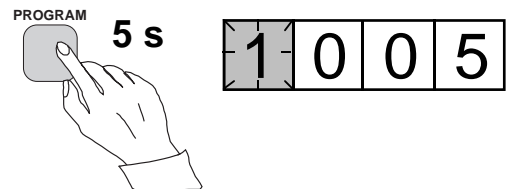

m)
After recording the desired values return to the main menu is obtained by pressing the STEP push button until the first digit is turned off. The LED indicator SGF still shows that one is in the SGF position and that the display shows the new checksum for SGF1 currently in use by the relay module.

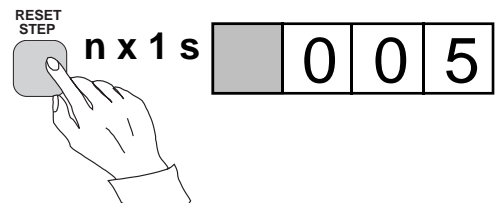

Recorded information

The parameter values measured at the moment when a fault occurs or at the trip instant are recorded in the registers. The recorded data, except for some parameters, are set to zero by pressing the push buttons STEP and PROGRAM simultaneously. The data in normal registers are erased if the auxiliary voltage supply to the relay is interrupted, only the set values and certain other essential parameters are maintained in non-volatile registers during a voltage failure.

The number of registers varies with different relay module types. The functions of the registers are illustrated in the descriptions of the different relay modules. Additionally, the system front panel of the relay contains a simplified list of the data recorded by the various relay modules of the protection relay.

All D type relay modules are provided with two general registers: register 0 and register A.

Register 0 contains, in coded form, the information about e.g. external blocking signals, status information and other signals. The codes are explained in the manuals of the different relay modules.

Register A contains the address code of the relay modul which is required by the serial communication system.

Submenu 1 of register A contains the data transfer rate value, expressed in kilobaud, of the serial communication.

Submenu 2 of register A contains a bus communication monitor for the SPAbus. If the protection relay, which contains the relay module, is linked to a system including a control data communicatoe, for instance SRIO 1000M and the data communication system is operating, the counter reading of the monitor will be zero. Otherwise the digits 1...255 are continuously scrolling in the monitor.

Submenu 3 contains the password required for changing the remote settings. The address code, the data transfer rate of the serial communication and the password can be set manually or via the serial communication bus. For manual setting see example 1.

The default value is 001 for the address code, 9.6 kilobaud for the data transfer rate and 001 for the password.

In order to secure the setting values, all settings are recorded in two separate memory banks within the non-volatile memory. Each bank is complete with its own checksum test to verify the condition of the memory contents. If, for some reason, the contents of one bank is disturbed, all settings are taken from the other bank and the contents from here is transferred to the faulty memory region, all while the relay is in full operation condition. If both memory banks are simultaneously damaged the relay will be set out of operation, and an alarm signal will be given over the serial port and the IRF output relay

Trip test function

Register 0 also provides access to a trip test function, which allows the output signals of the relay module to be activated one by one. If the auxiliary relay module of the protection assembly is in place, the auxiliary relays then will operate one by one during the testing.

When pressing the PROGRAM push button for about five seconds, the green digits to the right start flashing indicating that the relay module is in the test position. The indicators of the settings indicate by flashing which output signal can be activated. The required output function is selected by pressing the PROGRAM push button for about one second.

The indicators of the setting quantities refer to the following output signals:

Setting I>	Starting of stage I>
Setting t>	Tripping of stage I>
Setting I>>	Starting of stage I>>
Setting t>>	Tripping of stage I>>
etc.	
No indication	Self-supervision IRF

The selected starting or tripping is activated by simultaneous pressing of the push buttons STEP and PROGRAM. The signal remains activated as long as the two push buttons are pressed. The effect on the output relays depends on the configuration of the output relay matrix switches.

The self-supervision output is activated by pressing the STEP push button 1 second when no setting indicator is flashing. The IRF output is activated in about 1 second after pressing of the STEP push button.

The signals are selected in the order illustrated in Fig. 4.

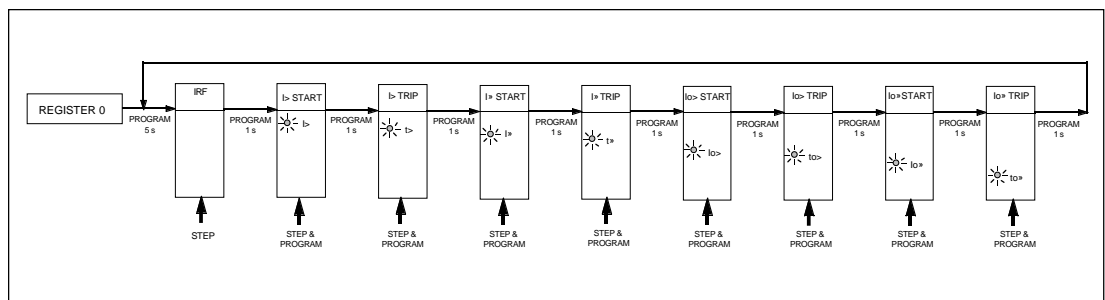

Fig. 5. Sequence order for the selection of output signals in the Trip test mode

If, for instance, the indicator of the setting t> is flashing, and the push buttons STEP and PROGRAM are being pressed, the trip signal from the low-set overcurrent stage is activated. Return to the main menu is possible at any stage of the trip test sequence scheme, by pressing the PROGRAM push button for about five seconds.

Note!

The effect on the output relays then depends on the configuration of the output relay matrix switchgroups SGR 1...3.

Example 3

Trip test function. Forced activation of the outputs.

- a)
Step forward on the display to register 0.

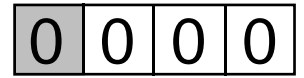
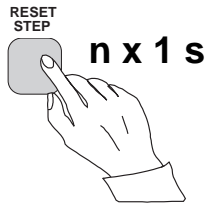

- b)
Press the PROGRAM push button for about five seconds until the three green digits to the right.

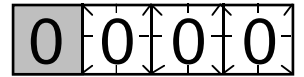
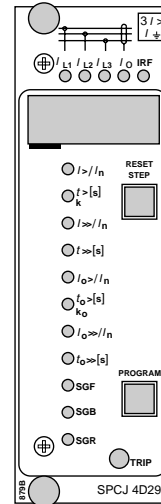
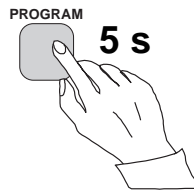

- c)
Hold down the STEP push button. After one second the red IRF indicator is lit and the IRF output is activated. When the step push button is released the IRF indicator is switched off and the IRF output resets.

- d)
Press the PROGRAM push button for one second and the indicator of the topmost setting start flashing.

- e)
If a start of the first stage is required, now press the push-buttons PROGRAM and STEP simultaneously. The stage output will be activated and the output relays will operate according to the actual programming of the relay output switchgroups SGR.

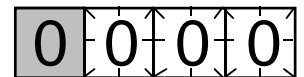
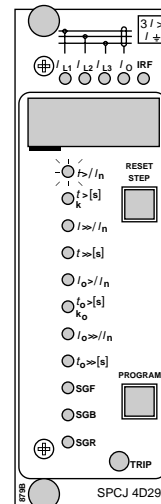
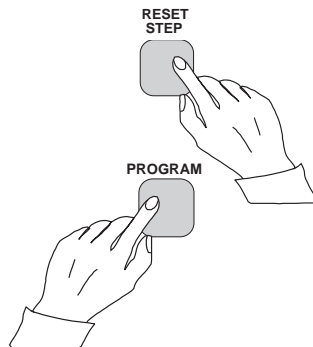

f)
To proceed to the next position press the PROGRAM push button for about 1 second until the indicator of the second setting starts flashing.

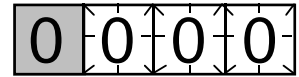
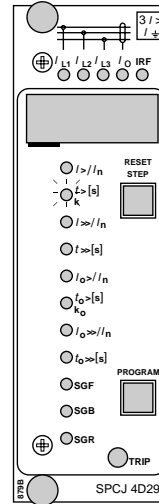

g)
Press the push buttons PROGRAM and STEP simultaneously to activate tripping of stage 1 (e.g. the I> stage of the overcurrent module SPCJ 4D29). The output relays will operate according to the actual programming of the relay switchgroups SGR. If the main trip relay is operated the trip indicator of the measuring module is lit.

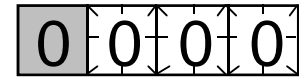
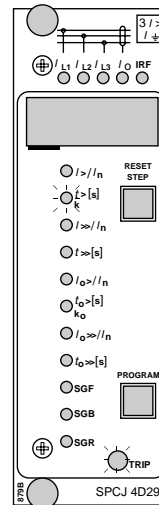
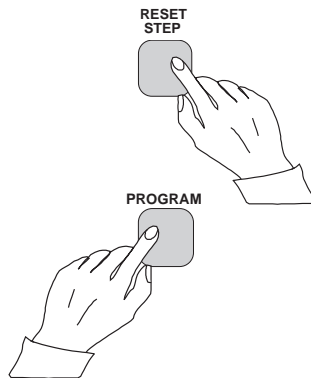

h)
The starting and tripping of the remaining stages are activated in the same way as the first stage above. The indicator of the corresponding setting starts flashing to indicate that the concerned stage can be activated by pressing the STEP and PROGRAM buttons simultaneously. For any forced stage operation, the output relays will respond according to the setting of the relay output switchgroups SGR. Any time a certain stage is selected that is not wanted to operate, pressing the PROGRAM button once more will pass by this position and move to the next one without carrying out any operation of the selected stage.

It is possible to leave the trip test mode at any step of the sequence scheme by pressing the PROGRAM push button for about five seconds until the three digits to the right stop flashing.

Operation indication

A relay module is provided with a multiple of separate operation stages, each with its own operation indicator shown on the display and a common trip indicator on the lower part of the front plate of the relay module.

The starting of a relay stage is indicated with one number which changes to another number when the stage operates. The indicator remains glowing although the operation stage resets. The

indicator is reset by means of the RESET push button of the relay module. An unreset operation indicator does not affect the function of the protection relay module.

In certain cases the function of the operation indicators may deviate from the above principles. This is described in detail in the descriptions of the separate modules.

Fault codes

In addition to the protection functions the relay module is provided with a self-supervision system which continuously supervises the function of the microprocessor, its program execution and the electronics.

Shortly after the self-supervision system detects a permanent fault in the relay module, the red IRF indicator on the front panel is lit. At the same time the module puts forward a control signal to the output relay of the self-supervision system of the protection relay.

In most fault situations a fault code, indicating the nature of the fault, appears on the display of

the module. The fault code, which consists of a red figure "1" and a three digit green code number, cannot be removed from the display by resetting. When a fault occurs, the fault code should be recorded and stated when service is ordered. When in a fault mode, the normal relay menus are operative, i.e. all setting values and measured values can be accessed although the relay operation is inhibited. The serial communication is also operative making it possible to access the relay information also from a remote site. The internal relay fault code shown on the display remains active until the internal fault possibly disappears and can also be remotely read out as variable V 169.

SPCJ 4D24

Combined overcurrent and earth-fault relay module

User's manual and Technical description

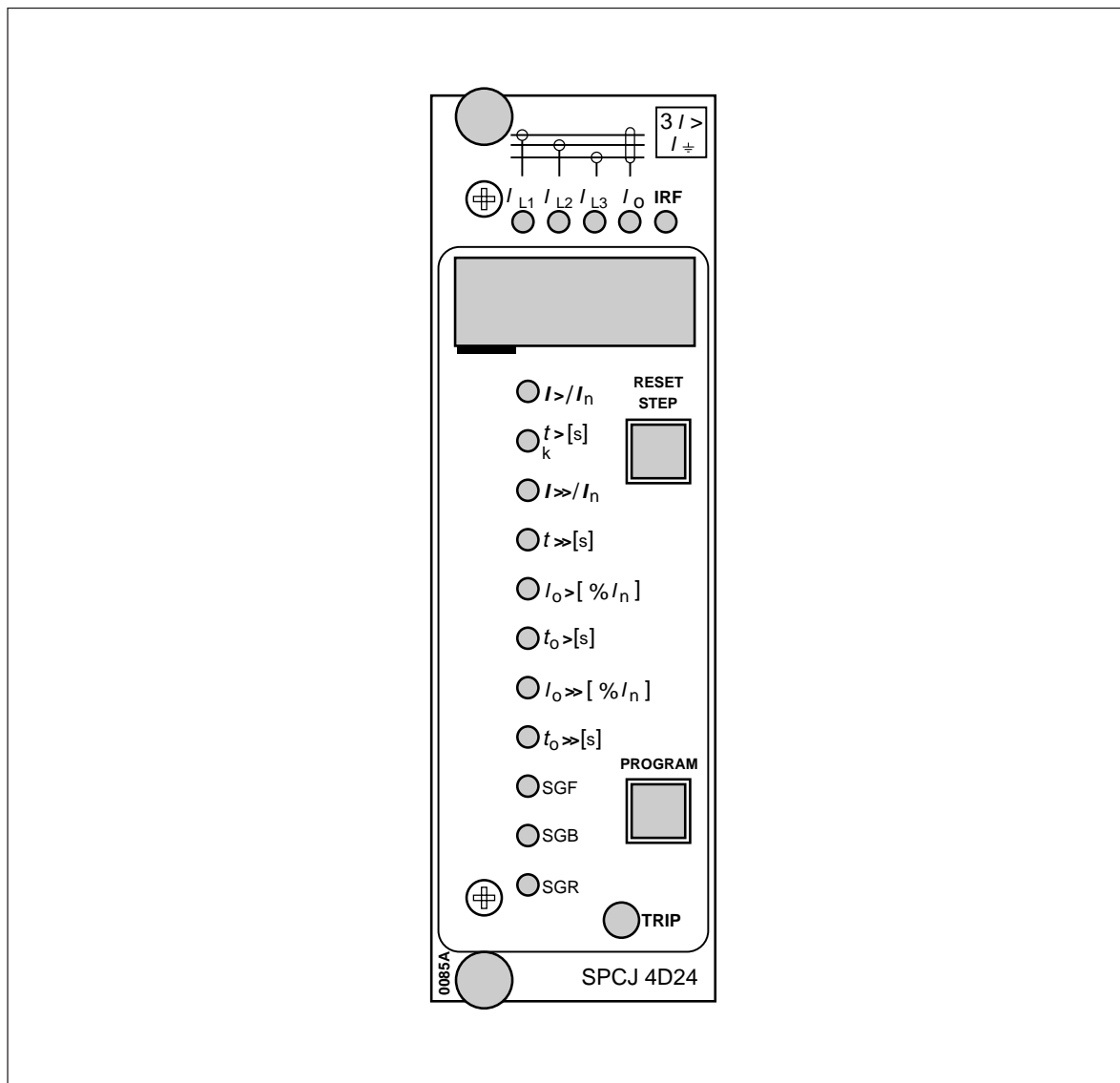

SPCJ 4D24

Combined overcurrent and earth-fault relay module

Data subject to change without notice

Contents	Features	2
	Description of function	3
	Block diagram	5
	Front panel	6
	Operation indicators	7
	Settings	8
	Programming switches	9
	Measured data	13
	Recorded information	14
	Main menus and submenus of settings and registers	16
	Time/current characteristics (<i>modified 2002-05</i>)	18
	Technical data	26
	Serial communication parameters	27
	Fault codes	34

Features

A low-set overcurrent stage $I_{>}$ with a definite time and six inverse time modes of operation

A high-set overcurrent stage $I_{>>}$ with a setting range of $0.5...40 \times I_n$. The operation of the high-set overcurrent stage can be set out of function

A low-set neutral overcurrent stage $I_{0>}$ with a setting range of $1.0...25.0 \% I_n$ and definite time mode of operation

A high-set neutral overcurrent stage $I_{0>>}$ with a setting range of $2.0...200 \% I_n$. The operation of the high-set neutral over current stage can be set out of function

Digital display of measured and set values and sets of data recorded at the moment when faults occur

All settings may be keyed in using the push-buttons of the front panel or they may be set using a personal computer

Continuous self-supervision including both hardware and software. At a permanent fault the alarm output relay operates and the other outputs are blocked.

Description of function

Overcurrent unit

The overcurrent unit of the combined overcurrent and earth-fault module SPCJ 4D24 is designed for single-phase, two-phase or three-phase operation. It contains two overcurrent stages, i.e. a low-set overcurrent stage $I_{>}$ and a high-set overcurrent stage $I_{>>}$.

The low-set or high-set current stage starts if the current on one of the phases exceeds the setting value of the stage concerned. When starting, the concerned stage provides a starting signal SS1 or TS1 and simultaneously the digital display on the front panel indicates starting. If the overcurrent situation lasts long enough to exceed the set operating time, the stage that started calls for a C.B. tripping by providing a tripping signal TS2. At the same time the operation indicator goes on with red light. The red operation indicator remains on although the stage resets. The indicator is reset with the RESET push-button. By proper configuration of the output relay switchgroups an additional auxiliary trip signal TS1 can be generated.

The maximum continuous current carrying capacity of the energizing inputs is $4 \times I_n$, which must be observed when relay settings are calculated.

The operation of the low-set overcurrent stage $I_{>}$ or the high-set overcurrent stage $I_{>>}$ can be blocked by bringing a blocking signal BS to the unit. The blocking configuration is set by means of switchgroup SGB.

The operation of the low-set overcurrent stage can be based on a definite time or an inverse time characteristic. The mode of operation is programmed with SGF1/1...3. At definite time mode of operation the operating time $t_{>}$ is directly set in seconds within the setting range, 0.05...300 s. When using inverse time mode of operation (I.D.M.T.) four internationally standardized and two special type time/current characteristics are available. The programming switches SGF1/1...3 are also used for selecting the desired operation characteristic.

The operating time $t_{>>}$ of the high-set overcurrent stage is set separately within the range 0.04...300 s.

The operation of the two overcurrent stages is provided with a latching facility (switch SGB/6) keeping the tripping output energized, although the signal which caused the operation disappears. The stages are reset by simultaneous pressing of the push-buttons RESET and PROGRAM, see section "Programming switches".

The setting value $I_{>>}/I_n$ of the high-set overcurrent stage may be subject to automatic doubling when connecting the protected object to the network, i.e. in a starting situation. Thus the setting value of the high-set overcurrent stage may be lower than the connection inrush current. The automatic doubling function is selected with switch SGF1/5. The starting situation is defined as a situation where the phase currents rise from a value below $0.12 \times I_{>}$ to a value exceeding $1.5 \times I_{>}$ in less than 60 ms. The starting situation comes to an end when the currents fall below $1.25 \times I_{>}$.

The setting range of the high-set overcurrent stage is $0.5...40 \times I_n$. When selecting a setting in the lower end of the range, the module will contain two almost identical operation stages. In this case the overcurrent unit of the SPCJ 4D24 module may be used for e.g. two-stage load shedding purposes.

The operation of the high-set overcurrent stage may be set out of operation by means of switch SGF2/5. When the high-set unit is set out of operation the display shows a "- - -" readout, indicating that the operating value is infinite.

Note!

At inverse time characteristic the effective setting range of the low-set overcurrent stage is $0.5...2.5 \times I_n$, although start current settings within the range $2.5...5.0 \times I_n$ can be set on the relay. At inverse time characteristic any start current setting above $2.5 \times I_n$ of the low-set stage will be regarded as being equal to $2.5 \times I_n$.

Note!

The operation of the low-set stage based on inverse time characteristic will be blocked by starting of the high-set stage. Then the operate time of the overcurrent unit is determined by the set operate time of the high-set stage at heavy fault currents.

Earth-fault unit	<p>The non-directional earth-fault unit of the module SPCJ 4D24 is a single-pole neutral current or residual current overcurrent unit. It contains two neutral overcurrent stages, i.e. a low-set overcurrent stage $I_{0>}$ and a high-set overcurrent stage $I_{0>>}$.</p> <p>The low-set or high-set overcurrent stage starts if the current to be measured exceeds the setting value of the stage concerned. When starting, the stage provides a starting signal SS1 or TS1 and simultaneously the operation indicator on the front panel indicates starting. If the earth-fault situation lasts long enough to exceed the set operating time, the stage that started calls for a C.B. tripping by providing a tripping signal TS2. At the same time the red operation indicator of the tripping stage goes on. The operation indicator remains on although the stage resets. The indicator is reset with the RESET push-button.</p> <p>The neutral current measured by the earth-fault unit is filtered in a low-pass filter which effectively reduces the amount of harmonics in the measured signal. For example the third harmonics is reduced to about ten percent of its original value by the filter. Higher order harmonics are reduced even more.</p> <p>The operation of the low-set overcurrent stage $I_{0>}$ or the high-set stage $I_{0>>}$ can be blocked by applying a blocking signal BS onto the stage. The blockings are programmed by means of switchgroup SGB on the front of the plug-in module.</p>	<p>The operation of the low-set neutral current stage $I_{0>}$ is based on a definite time characteristic. The operating time $t_{0>}$ can be set within the setting range 0.05...300 s.</p> <p>The operating time $t_{0>>}$ of the high-set current stage is set separately within the range 0.05...300 s.</p> <p>The operation of the two neutral overcurrent stages is provided with a latching facility (switch SGB/7) keeping the tripping output energized, although the signal which caused the operation disappears. The stages are reset by simultaneous pressing of the push-buttons RESET and PROGRAM, see section "Programming switches".</p> <p>The operation of the high-set earth-fault stage may be inhibited when connecting the protected object to the network, i.e. when the low-set stage of the overcurrent unit is started. Thus it is possible to avoid malfunction due to virtual earth-fault currents caused by current transformer anomalies in connection with the connection inrush current. The automatic inhibiting function is selected with switch SGF1/6.</p> <p>The operation of the high-set earth-fault stage $I_{0>>}$ may be totally blocked by means of switch SGF2/6. When the high-set stage is set out of operation, the display shows a "- - -" readout, indicating that the setting value is infinite.</p>
Circuit breaker failure protection	<p>The unit is also provided with a circuit breaker failure protection (CBFP), which gives a trip signal via TS1 within a set time 0.1...1 s after the normal trip signal TS2, if the fault has not been cleared within that time. The output contact of the circuit breaker failure protection is normally used for tripping an upstream circuit breaker. The CBFP can also be used to estab-</p>	<p>lish a redundant trip system by using dual trip coils on the circuit breaker and wiring one of them to TS2 and the other one to TS1. The circuit breaker failure protection is selected by means of switch SGF1/4. The setting of the time delay can be made using submenu position five in register A.</p>
Remote settings	<p>All the main setting values may be provided with alternative setting values that can be called up by remote control. The switching between main and remote settings is normally made by utilizing the serial communication link. If the serial</p>	<p>communication is not used, the control input signal BS can be programmed to perform the switching too. Finally manual switching between setting banks can be made using submenu position four in register A.</p>

Block diagram

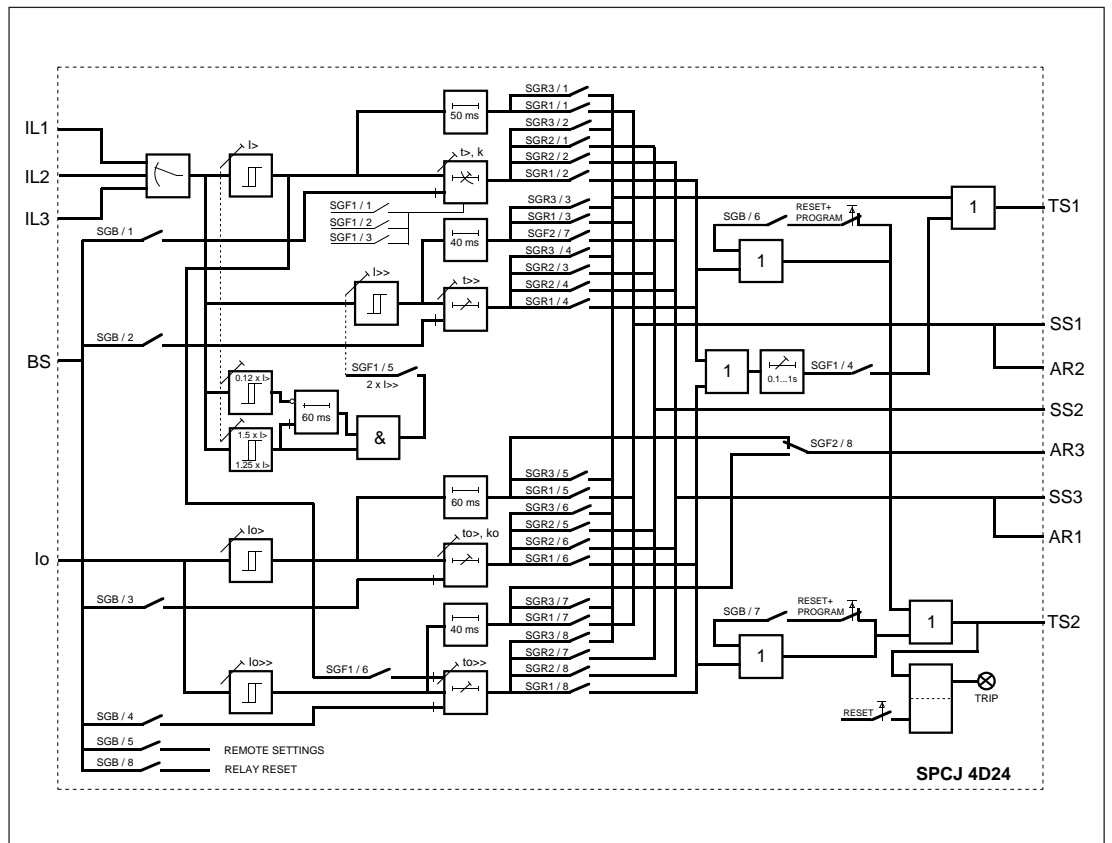

Fig. 1. Block diagram for overcurrent and earth-fault module SPCJ 4D24

I_{L1}, I_{L2}, I_{L3}	Measured phase currents
I_0	Measured neutral current
BS1	External blocking or resetting signal
SGF	Programming switchgroup SGF on the front panel
SGB	Programming switchgroup SGB on the front panel
SGR1...3	Programming switchgroups SGR on the front panel
TS1	Starting signal1 or auxiliary tripping signal depending on programming of switchgroup SGR3
SS1	Start signal for stages selected with switchgroup SGR1
SS2	Trip signal 1 for stages selected with switchgroup SGR2
SS3	Trip signal 2 for stages selected with switchgroup SGR2
TS2	Tripping signal from stages selected with switchgroup SGR1
AR1, AR2, AR3	Starting signals to autoreclose unit
TRIP	Red indicator for tripping

Note!

All input and output signals of the module are not necessarily wired to the terminals of every relay assembly using this module. The signals wired to the terminals are shown in the diagram illustrating the flow of signals between the plug-in modules of the relay assembly.

Current measurement indicators
for phases L1, L2, L3 and I₀

- Indicator for starting value setting of stage I>
- Indicator for setting of operating time t> or time multiplier k of stage I>
- Indicator for starting value setting of stage I>>
- Indicator for operating time setting of stage I>>
- Indicator for starting value setting of stage I₀>
- Indicator for setting of operating time t₀>
- Indicator for starting value setting of stage I₀>>
- Indicator for operating time setting of stage I₀>>
- Indicator for switchgroup SGF1..2 checksum
- Indicator for switchgroup SGB checksum
- Indicator for switchgroup SGR1...3 checksum

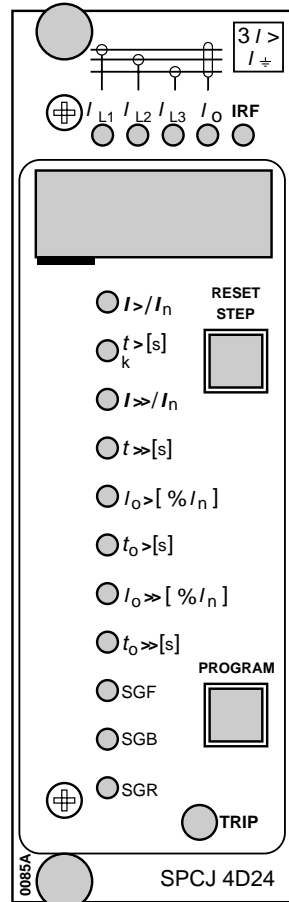
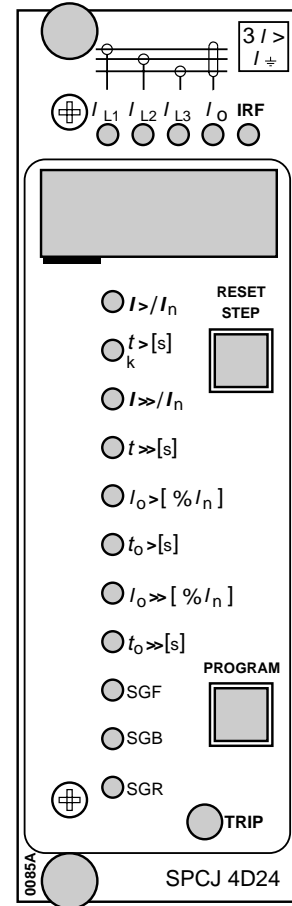

Simplified device symbol

Self-supervision alarm indicator

Display

Reset and display step push-button

Programming push-button

Trip indicator

Type designation of plug-in module

Fig. 2. Front panel of the combined overcurrent and earth-fault module SPCJ 4D24

Operation indications

Each overcurrent stage has its own starting indicator and operation indicator shown as a figure in the digital display. Further all stages share a common red LED indicator named "TRIP", which indicates that the module has delivered a tripping signal.

The operation indicator in the display remains illuminated when the current stage resets, thus indicating which protection stage was operating. The operation indicator is reset with the

RESET push-button. The function of the plug-in module is not affected by an activated operation indicator. If a starting of a stage is short enough not to cause a trip, the starting indication is normally self-reset when the stage is reset. By means of switches SGF2/1...4 if needed, the starting indicators can be programmed for manual resetting. The following table shows the starting and tripping indicators and their meanings.

Indication	Explanation
1	I> START = The low-set stage I> of the overcurrent unit has started
2	I> TRIP = The low-set stage I> of the overcurrent unit has tripped
3	I>> START = The high-set stage I>> of the overcurrent unit has started
4	I>> TRIP = The high-set stage I>> of the overcurrent unit has tripped
5	I ₀ > START = The low-set stage I ₀ > of the earth-fault unit has started
6	I ₀ > TRIP = The low-set stage I ₀ > of the earth-fault unit has tripped
7	I ₀ >> START = The high-set stage I ₀ >> of the earth-fault unit has started
8	I ₀ >> TRIP = The high-set stage I ₀ >> of the earth-fault unit has started
9	CBFP = The circuit breaker failure protection has operated

When one of the protection stages of the module performs a tripping, the indicators for the measured values of the module indicate the faulty phase, i.e. in which phase(s) the current has exceeded the setting value of the stage (so called phase fault indication). If for instance, the operation indicator of the I> stage is switched goes on and the indicators I_{L1} and I_{L2} are illuminated, the operation was caused by overcurrent in phases L1 and L2. When pressing the push-button RESET, the phase fault indication disappears.

The self-supervision alarm indicator IRF indicates that the self-supervision system has detected a permanent fault. The indicator is lit with red light shortly after the fault has been detected. At the same time the plug-in module delivers a signal to the self-supervision system output relay of the protection assembly. Additionally, in most fault cases, a fault code showing the nature of the fault appears on the display of the module. The fault code, consisting of a red figure one and a green code number, persists until the STEP/RESET button is pressed. When a fault occurs, the fault code should be recorded and stated when ordering service.

Settings

The setting values are shown by the right-most three digits of the display. An indicator close to the setting value symbol shows when illumi-

nated which setting value is indicated on the display.

$I_{>}/I_n$	The operating current of the $I_{>}$ stage as a multiple of the rated current of the protection. Setting range $0.5...5.0 \times I_n$ at definite time characteristic and $0.5...2.5 \times I_n$ at inverse time characteristic.
$t_{>}$ k	The operating time of the $I_{>}$ stage, expressed in seconds, when in the definite time mode of operation (SGF1/1-2-3 = 0-0-0). The setting range is 0.05...300 s. At inverse definite minimum time mode of operation the time multiplier k setting range is 0.05...1.00.
$I_{>>}/I_n$	The starting current of the $I_{>>}$ stage as a multiple of the rated current of the protection. Setting range $0.5...40.0 \times I_n$. Additionally, the setting "infinite" (displayed as n - - -) can be selected, with switch SGF2/5, which makes the stage $I_{>>}$ inoperative.
$t_{>>}$	The operating time of the $I_{>>}$ stage, expressed in seconds. The setting range is 0.04...300 s
$I_{0>}/I_n$	The starting current of the $I_{0>}$ stage as a per cent of the rated current of the protection. Setting range 1.0...25.0 % I_n .
$t_{0>}$	The operating time of the $I_{0>}$ stage, expressed in seconds. The setting range is 0.05...300 s
$I_{0>>}/I_n$	The starting current of the $I_{0>>}$ stage as a percent of the rated current of the protection. Setting range 2.0...200% I_n . Additionally, the setting "infinite" set by switch SGF2/6 (displayed as n - - -) can be selected with switch SGF2/6 which makes the stage $I_{0>>}$ inoperative.
$t_{0>>}$	The operating time of the $I_{0>>}$ stage, expressed in seconds. The setting range is 0.05...300 s

Further, the checksums of the programming switchgroups SGF1, SGB and SGR1 are indicated on the display when the indicators adjacent to the switchgroup symbols on the front panel are illuminated. The checksums for groups SGF2, SGR2 and SGR3 are found in

the submenus of the corresponding first switchgroup. See further clause "Main menus and submenus of settings and registers". An example of calculating the checksum is given in the general description of the D-type SPC relay modules.

Programming switches

Additional functions required by individual applications are selected by means of the switchgroups SGF, SGB and SGR indicated on the front panel. The numbering of the switches, 1...8, and the switch positions 0 and 1 are indi-

cated when setting the switchgroups. In normal service only the checksums are shown. The switchgroups SGF2, SGR2 and SGR3 are found in the submenus of the switchgroups SGF and SGR.

Functional switchgroup SGF1

Switch	Function																																													
SGF1/1 SGF1/2 SGF1/3	<p>Switches SGF1/1...3 are used for selecting the operation characteristic of the low-set overcurrent stage I>, i.e. definite time mode of operation or inverse definite minimum time (I.D.M.T.) mode of operation. At inverse definite minimum time mode of operation the switches are, further, used for selecting the current/time characteristic of the module.</p> <table border="1"> <thead> <tr> <th>SGF1/1</th> <th>SGF1/2</th> <th>SGF1/3</th> <th>Mode of operation</th> <th>Characteristics</th> </tr> </thead> <tbody> <tr> <td>0</td> <td>0</td> <td>0</td> <td>Definite time</td> <td>0.05...300 s</td> </tr> <tr> <td>1</td> <td>0</td> <td>0</td> <td>I.D.M.T</td> <td>Extremely inverse</td> </tr> <tr> <td>0</td> <td>1</td> <td>0</td> <td>"</td> <td>Very inverse</td> </tr> <tr> <td>1</td> <td>1</td> <td>0</td> <td>"</td> <td>Normal inverse</td> </tr> <tr> <td>0</td> <td>0</td> <td>1</td> <td>"</td> <td>Long-time inverse</td> </tr> <tr> <td>1</td> <td>0</td> <td>1</td> <td>"</td> <td>RI-characteristic</td> </tr> <tr> <td>0</td> <td>1</td> <td>1</td> <td>"</td> <td>RXIDG-characteristic</td> </tr> <tr> <td>1</td> <td>1</td> <td>1</td> <td>"</td> <td>Not in use (long-time inverse)</td> </tr> </tbody> </table>	SGF1/1	SGF1/2	SGF1/3	Mode of operation	Characteristics	0	0	0	Definite time	0.05...300 s	1	0	0	I.D.M.T	Extremely inverse	0	1	0	"	Very inverse	1	1	0	"	Normal inverse	0	0	1	"	Long-time inverse	1	0	1	"	RI-characteristic	0	1	1	"	RXIDG-characteristic	1	1	1	"	Not in use (long-time inverse)
SGF1/1	SGF1/2	SGF1/3	Mode of operation	Characteristics																																										
0	0	0	Definite time	0.05...300 s																																										
1	0	0	I.D.M.T	Extremely inverse																																										
0	1	0	"	Very inverse																																										
1	1	0	"	Normal inverse																																										
0	0	1	"	Long-time inverse																																										
1	0	1	"	RI-characteristic																																										
0	1	1	"	RXIDG-characteristic																																										
1	1	1	"	Not in use (long-time inverse)																																										
SGF1/4	<p>Selection of the circuit breaker failure protection.</p> <p>When SGF1/4 = 1 the trip signal TS2 will start a timer which will produce a 0.1...1 s delayed trip signal via TS1, if the fault has not been cleared before. With switch SGF1/4 = 0 only the normal trip signal TS2 is activated.</p>																																													
SGF1/5	<p>Selection of automatic doubling of the setting value of the high-set overcurrent stage when the protected object is energized.</p> <p>When SGF1/5 = 0, no doubling of the setting value I>> is obtained. When SGF1/5 = 1, the setting value of the I>> stage doubles automatically. This makes it possible to give the high-set current stage a setting value below the connection inrush current level.</p>																																													
SGF1/6	<p>High-set stage of the earth-fault protection inhibited by starting of the low-set stage of the overcurrent unit</p> <p>When SGF1/6 = 0, the operation of the high-set earth-fault protection is operating under all phase current conditions When SGF1/6 = 1, the earth-fault protection is inhibited if the low-set stage of the overcurrent unit has started</p>																																													
SGF1/7	Reserved for future use																																													
SGF1/8	Reserved for future use																																													

Functional switch-
group SGF2

Switch	Function
SGF2/1 SGF2/2 SGF2/3 SGF2/4	<p>Switches SGF2/1...4 are used for selecting the mode of operation of the starting indicators of the different stages. When the switches are in position 0 the starting signals are all automatically reset when the fault is cleared. In order to get a hand reset starting indication for a stage, the corresponding switch is brought into position 1:</p> <p>SGF2/1 = 1 equals manual resetting of the starting indication of stage I> SGF2/2 = 1 equals manual resetting of the starting indication of stage I>> SGF2/3 = 1 equals manual resetting of the starting indication of stage I₀> SGF2/4 = 1 equals manual resetting of the starting indication of stage I₀>></p>
SGF2/5	<p>The high-set instantaneous operation of the stage I>> can be set out of operation by means of this switch.</p> <p>When SGF2/5 = 0 the high-set stage I>> is operative When SGF2/5 = 1 the high-set stage I>> is blocked and the display shows "- - -"</p>
SGF2/6	<p>The high-set instantaneous operation of the stage I₀>> can be completely set out of operation by means of this switch.</p> <p>When SGF2/6 = 0 the high-set stage I₀>> is operative When SGF2/6 = 1 the high-set stage I₀>> is blocked and the display shows "- - -"</p>
SGF2/7	<p>The starting signal of the high-set overcurrent stage I>> brought to the auto-reclose signal output AR1</p> <p>When SGF2/7 = 1, the starting signal of I>> is controlling AR1. Note! The output is equal to SS3, which means that in this case an other signal must not be connected to same output! When SGF2/7 = 0, the starting output of I>> is not affecting the output AR1 or SS3. Thus the signal output SS3 is available for other purposes.</p>
SGF2/8	<p>The starting signal from stage I₀>- or stage I₀>>- brought to auto-reclose signal output AR3</p> <p>When SGF2/8 = 0 the starting signal from stage I₀> is controlling AR3 When SGF2/8 = 1 the starting signal from stage I₀>> is controlling AR3</p>

Switch	Function
SGB/1...4	<p>Switches SGB/1...4 are used when the external control signal BS is to be used for blocking one or more of the current stages of the module. When all the switches are in position 0 no stage is blocked.</p> <p>When SGB/1 = 1, the stage I> is blocked by the input signal BS When SGB/2 = 1, the stage I>> is blocked by the input signal BS When SGB/3 = 1, the stage I₀> is blocked by the input signal BS When SGB/4 = 1, the stage I₀>> is blocked by the input signal BS</p>
SGB/5	<p>This switch enables switching over from the main settings to the second settings and vice versa even without serial communication, using the external control input signal BS.</p> <p>When SGB/5 = 0, the settings are not to be remotely controlled or they are controlled via the serial communication only When SGB/5 = 1, the settings are remotely controlled or via the external input. Main values of the settings are used when there is no control voltage on the input and the second settings are enforced when a control voltage is connected to the control input.</p> <p>Note! Whenever main and second settings are used, care should be taken that the switch SGB/5 has the same position both in the main and second setting bank. Otherwise a conflict situation might occur when switching setting banks by contact or via serial communication.</p>
SGB/6	<p>Selection of a latching feature for the tripping signal TS2 for overcurrent faults.</p> <p>When SGB/6 = 0, the tripping signal returns to its initial state (= the output relay drops off), when the measuring signal causing the operation falls below the starting level. When SGB/6 = 1, the tripping signal remains on (= the output relay operated), although the measuring signal falls below the starting level. Then the starting signals have to be reset by pressing the push-buttons RESET and PROGRAM simultaneously. ¹⁾</p>
SGB/7	<p>Selection of a latching feature for the trip signal TS2 for earth faults.</p> <p>When SGB/7 = 0, the tripping signal returns to its initial state (= the output relay drops off), when the measuring signal causing the operation falls below the starting level. When SGB/7 = 1, the tripping signal remains on (= the output relay operated), although the measuring signal falls below the starting level. Then the starting signals have to be reset by pressing the push-buttons RESET and PROGRAM simultaneously. ¹⁾</p>
SGB/8	<p>Remote resetting of a latched output relay.</p> <p>When the output relay with SGB/6 or SGB/7 has been selected to be latching, a remote relay reset can be performed using the control input signal BS when SGB/8 = 1. When delivered from factor all switches SGB are set at zero, i.e. the checksum SGB is 0.</p>

¹⁾ From the program version 042D and later versions an additional feature has been incorporated into the relay module SPCJ 4D24.

When the latching function is used the latched output can be reset by pushing the PROGRAM button alone, in which case the stored information of the module is not erased.

Output relay matrix
switchgroups SGR1,
SGR2 and SGR3

SGR1	The switches of switchgroup SGR1 are used to select the protective stages to be brought to the starting signal output SS1 and the tripping signal output TS2.
SGR2	The switches of switchgroup SGR2 are used for configuring the tripping signals of the different protective stages. There are two outputs, SS2 and SS3, to which the signals can be linked.
SGR3	The switches of switchgroup SGR3 are used for configuring the starting and tripping signals to the starting or auxiliary tripping output TS1. Note! If the circuit breaker failure protection has been selected in with switch SGF1/4, it will also utilize the TS1 output.

Switch	Function	Factory setting	Checksum value
SGR1/1	When SGR1/1 = 1, the starting signal of stage I> is linked to SS1	1	1
SGR1/2	When SGR1/2 = 1, the tripping signal of stage I> is linked to TS2	1	2
SGR1/3	When SGR1/3 = 1, the starting signal of stage I>> is linked to SS1	0	4
SGR1/4	When SGR1/4 = 1, the tripping signal of stage I>> is linked to TS2	1	8
SGR1/5	When SGR1/5 = 1, the starting signal of stage I ₀ > is linked to SS1	0	16
SGR1/6	When SGR1/6 = 1, the tripping signal of stage I ₀ > is linked to TS2	1	32
SGR1/7	When SGR1/7 = 1, the starting signal of stage I ₀ >> is linked to SS1	0	64
SGR1/8	When SGR1/8 = 1, the tripping signal of stage I ₀ >> is linked to TS2	1	128
Checksum for factory setting of SGR1			171

SGR2/1	When SGR2/1 = 1, the tripping signal from stage I> is linked to SS2	1	1
SGR2/2	When SGR2/2 = 1, the tripping signal from stage I> is linked to SS3	0	2
SGR2/3	When SGR2/3 = 1, the tripping signal from stage I>> is linked to SS2	1	4
SGR2/4	When SGR2/4 = 1, the tripping signal from stage I>> is linked to SS3	0	8
SGR2/5	When SGR2/5 = 1, the tripping signal from stage I ₀ > is linked to SS2	0	16
SGR2/6	When SGR2/6 = 1, the tripping signal from stage I ₀ > is linked to SS3	1	32
SGR2/7	When SGR2/7 = 1, the tripping signal from stage I ₀ >> is linked to SS2	0	64
SGR2/8	When SGR2/8 = 1, the tripping signal from stage I ₀ >> is linked to SS3	1	128
Checksum for factory setting of SGR2			165

Switch	Function	Factory setting	Checksum value
SGR3/1	When SGR3/1 = 1, the starting signal of stage I> is linked to TS1	0	1
SGR3/2	When SGR3/2 = 1, the tripping signal of stage I> is linked to TS1	0	2
SGR3/3	When SGR3/3 = 1, the starting signal of stage I>> is linked to TS1	0	4
SGR3/4	When SGR3/4 = 1, the tripping signal of stage I>> is linked to TS1	0	8
SGR3/5	When SGR3/5 = 1, the starting signal of stage I ₀ > is linked to TS1	0	16
SGR3/6	When SGR3/6 = 1, the tripping signal of stage I ₀ > is linked to TS1	0	32
SGR3/7	When SGR3/7 = 1, the starting signal of stage I ₀ >> is linked to TS1	0	64
SGR3/8	When SGR3/8 = 1, the tripping signal of stage I ₀ >> is linked to TS1	0	128
Checksum for factory setting of SGR3			0

Measured data

The measured values are displayed by the three right-most digits of the display. The currently measured data are indicated by an illuminated LED indicator on the front panel.

Indicator	Measured data
I _{L1}	Line current on phase L1 as a multiple of the rated current I _n (0...63 x I _n)
I _{L2}	Line current on phase L2 as a multiple of the rated current I _n (0...63 x I _n)
I _{L3}	Line current on phase L3 as a multiple of the rated current I _n (0...63 x I _n)
I ₀	Neutral current as a per cent of the rated current I _n (0...210% I _n)

Recorded information

The left-most red digit displays the register address and the other three digits the recorded information.

A symbol "///" in the text indicates that the following item is found in a submenu.

Register/ STEP	Recorded information
1	Phase current I_{L1} measured as a multiple of the rated current of the overcurrent protection. If the overcurrent stage starts or performs a tripping, the current value at the moment of tripping is stored in a memory stack. A new tripping moves the old value up one place in the stack and adds a new value to the stack. At a maximum five values are memorized - if a sixth starting occurs, the oldest value will be lost.
2	Phase current I_{L2} measured as a multiple of the rated current of the overcurrent protection. If the overcurrent stage starts or performs a tripping, the current value at the moment of tripping is stored in a memory stack. A new tripping moves the old value up one place in the stack and adds a new value to the stack. At a maximum five values are memorized - if a sixth starting occurs, the oldest value will be lost.
3	Phase current I_{L3} measured as a multiple of the rated current of the overcurrent protection. If the overcurrent stage starts or performs a tripping, the current value at the moment of tripping is stored in a memory stack. A new tripping moves the old value up one place in the stack and adds a new value to the stack. At a maximum five values are memorized - if a sixth starting occurs, the oldest value will be lost.
4	Maximum demand current value for a period of 15 minutes expressed in multiples of the relay rated current I_n and based on the highest phase current. // Highest maximum demand value found since latest full relay reset.
5	Duration of the latest starting situation of stage I> as a percentage of the set operating time $t_{>}$ or at I.D.M.T. mode of operation the calculated operation time. A new starting resets the counter, which then starts counting from zero and moves the old value up in the memory stack. At a maximum five values are memorized - if a sixth starting occurs the oldest value will be lost. When the concerned stage has tripped, the counter reading is 100. // Number of startings of the low-set overcurrent stage I>, $n(I>) = 0...255$.
6	Duration of the latest starting situation of stage I>> as a percentage of the set operating time $t_{>>}$. A new starting resets the counter, which then starts counting from zero and moves the old value up in the memory stack. At a maximum five values are memorized - if a sixth starting occurs, the oldest value will be lost. When the concerned stage has tripped, the counter reading is 100. // Number of startings of the high-set overcurrent stage I>>, $n(I>>) = 0...255$.
7	Neutral overcurrent I_0 measured as a per cent of the rated current of the earth-fault protection. If the earth-fault stage starts or performs a tripping, the current value at the moment of tripping is stored in a memory stack. A new tripping moves the old value up one place in the stack and adds a new value to the stack. At a maximum five values are memorized - if a sixth starting occurs, the oldest value will be lost.

Register/ STEP	Recorded information
8	Duration of the latest starting situation of stage $I_{0>}$ as a percentage of the set operating time $t_{0>}$. A new starting resets the counter, which then starts counting from zero and moves the old value up in the memory stack. At a maximum five values are memorized - if a sixth starting occurs the oldest value will be lost. When the concerned stage has tripped, the counter reading is 100. // Number of startings of the low-set neutral overcurrent stage $I_{0>}$, $n(I_{0>}) = 0...255$.
9	Duration of the latest starting situation of stage $I_{0>>}$ as a percentage of the set operating time $t_{0>>}$. A new starting resets the counter, which then starts counting from zero and moves the old value up in the memory stack. At a maximum five values are memorized - if a sixth starting occurs, the oldest value will be lost. When the concerned stage has tripped, the counter reading is 100. // Number of startings of the high-set neutral overcurrent stage $I_{0>>}$, $n(I_{0>>}) = 0...255$.
0	<p>Display of blocking signals and other external control signals.</p> <p>The right-most digit indicates the state of the blocking input of the unit. The following states may be indicated: 0 = no blocking signal 1 = the blocking or control signal BS is active.</p> <p>The effect of the signal on the unit is determined by the setting of switchgroup SGB</p> <p>From this register "0" it is possible to move on to the TEST mode, where the starting and tripping signals of the module are activated one by one. For further details see the description "General characteristics of D-type SPC relay units".</p>
A	<p>The address code of the measuring relay module, required by the serial communication system. The address code is set at zero unless the serial communication system is used.</p> <p>The submenus of this register comprise the selection of the data transfer rate of the serial communication, a bus traffic monitor indicating the operating state of the serial communication system, a password required for the remote control of the settings and a status information for the main/second setting bank, and finally the setting of time delay for the circuit breaker failure protection.</p> <p>If the module is connected to a system including a control data communicator and if the communication system is operating, the counter reading of the bus traffic monitor will be zero. Otherwise the numbers 0...255 are continuously rolling in the counter. The password given in the setting mode of the next submenu step must always be entered via the serial communication before settings can be remotely altered. With the setting selector status in the fourth submenu either the main setting bank or the second setting bank can be made active.</p>
-	Display dark. By pressing the STEP push-button the beginning of the display sequence is re-entered.

The registers 1...9 are set to zero by pressing the push-buttons RESET and PROGRAM simultaneously. The registers are also cleared if the auxiliary power supply of the module is interrupted. The address code of the plug-in module, the data transfer rate of the serial commu-

nication, the password and the status of the main/second setting bank switch are not erased by a voltage failure. The instructions for setting the address and the data transfer rate are described in the "General characteristics of D-type SPC relay units".

Main menus and submenus of settings and registers

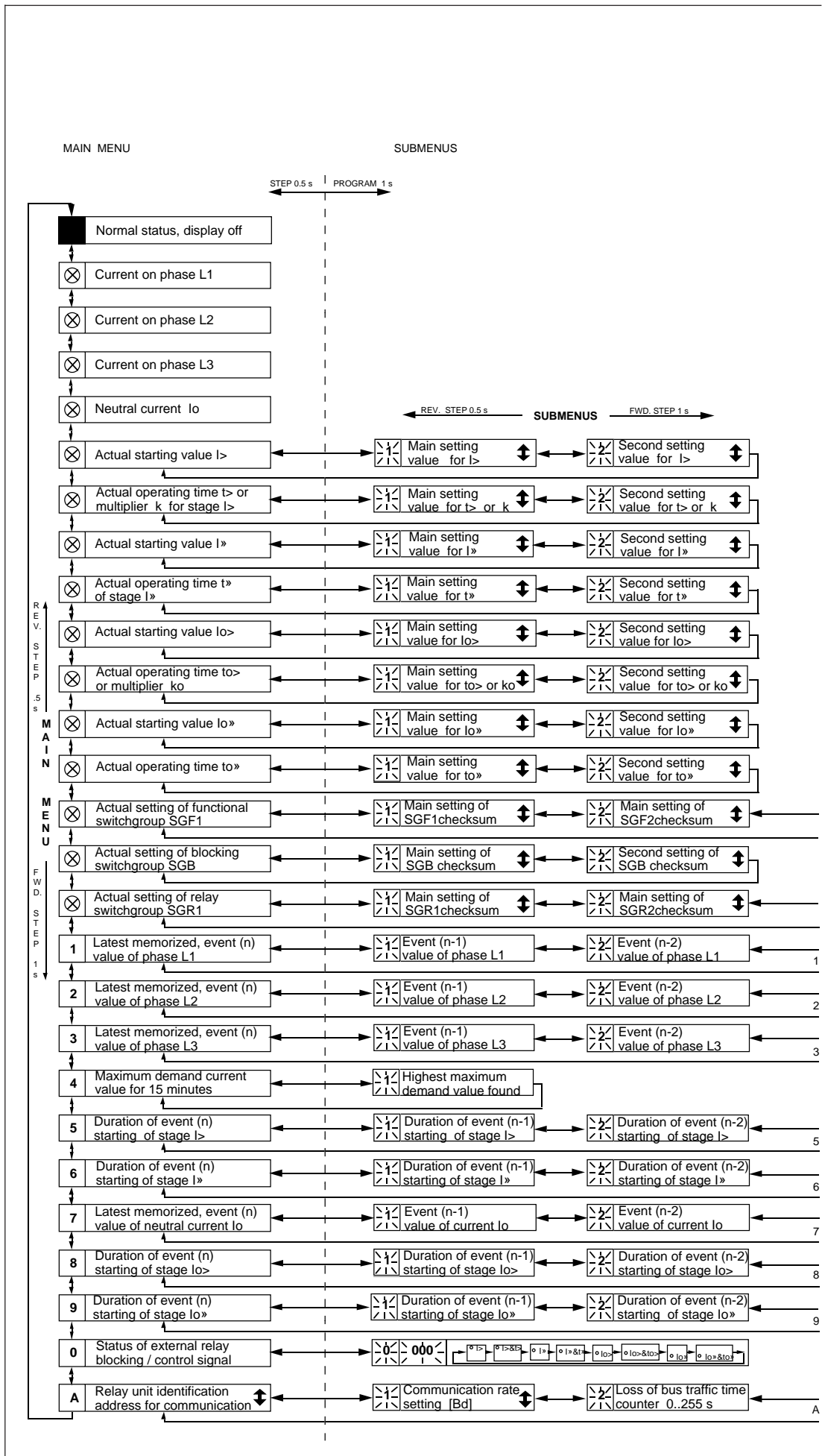

The measures required for entering a submenu or a setting mode and how to perform the setting and use the TEST mode are described in

detail in the manual "General characteristics of the D-type relay modules". A short form guide to the operations is shown below.

Desired step or programming operation	Push-button	Action
Forward step in main or submenu	STEP	Press for more than 0.5 s
Rapid scan forward in main menu	STEP	Keep depressed
Reverse step in main or submenu	STEP	Press less than about 0.5 s
Entering to submenu from main menu	PROGRAM	Press for 1 s (Active on release)
Entering or leaving setting mode	PROGRAM	Press for 5 s
Increasing a value in setting mode	STEP	
Moving the cursor in setting mode	PROGRAM	Press for about 1 s
Storing a value in setting mode	STEP&PROGRAM	Press simultaneously
Resetting of memorized values and latched output relays	STEP&PROGRAM	
Resetting of latched output relays	PROGRAM	Note! Display must be off

Note! All parameters which can be set in a setting mode are indicated with the symbol \updownarrow .

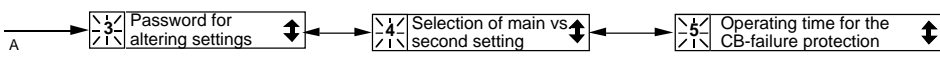
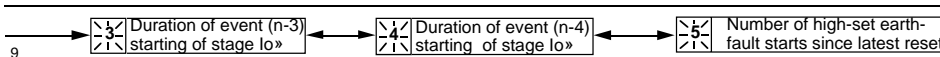
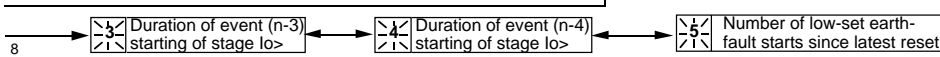
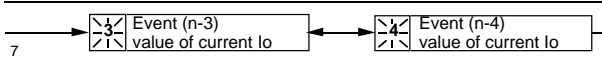
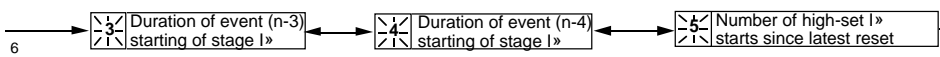
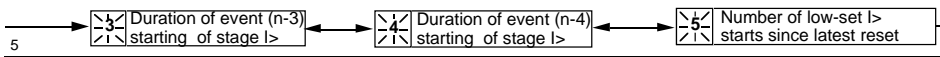
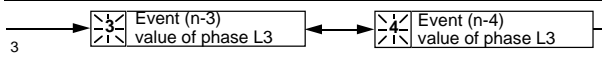
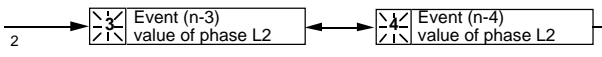
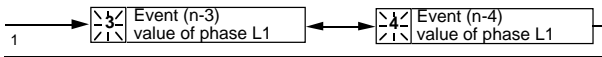
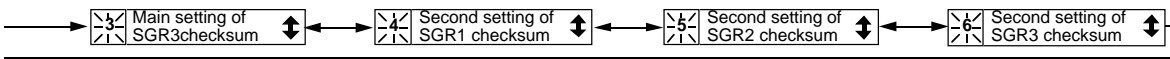
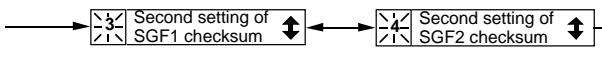

Time/current characteristics
(modified 2002-05)

The operation of the low-set overcurrent stage I> of the module is based on either definite time or inverse time characteristics. The mode of operation is selected with switches 1...3 of switchgroup SGF1 (see page 9).

When selecting an IDMT mode of operation,

the operating time of the stage will be a function of the current; the higher the current, the shorter the operating time. The unit comprises of six different time/current characteristics - four according to the BS 142 standard and two special types called the RI and RXIDG characteristic..

BS-type characteristics

There are four standard curves, extremely, very, normal and long- time inverse. The relationship between current and time complies with the standards BS 142.1966 and IEC 60255-3 and may generally be expressed as:

$$t [s] = \frac{k \times \beta}{(I/I>)^{\alpha} - 1}$$

where t = operating time in seconds
k = time multiplier
I = current value
I> = set current value

The unit includes four BS 142-specified characteristics with different degrees of inversivity.

The degree of inversivity is determined by the values of the constants α and β

Degree of inversivity of the characteristic	α	β
Normal inverse	0.02	0.14
Very inverse	1.0	13.5
Extremely inverse	2.0	80.0
Long-time inverse	1.0	120.0

According to the standard BS 142.1966 the normal current range is defined as 2...20 times the setting current. Additionally the relay must start at the latest when the current exceeds a value of 1.3 times the setting, when the time/current characteristic is normal inverse, very inverse or extremely inverse. When the characteristic is long-time inverse, the normal range in accordance with the standard is 2...7 times the setting and the relay is to start when the current exceeds 1.1 times the setting.

The following requirements with regard to operating time tolerances are specified in the standard (E denotes accuracy in per cent, - = not specified):

I/I>	Normal inv.	Very inv.	Extremely inv.	Long-time inv.
2	2.22 E	2.34 E	2.44 E	2.34 E
5	1.13 E	1.26 E	1.48 E	1.26 E
7	-	-	-	1.00 E
10	1.01 E	1.01 E	1.02 E	-
20	1.00 E	1.00 E	1.00 E	-

In the defined normal current ranges, the inverse-time stage of the overcurrent and earth-fault unit SPCJ 4D24 complies with the tolerances of class 5 at all degrees of inversivity.

The time/current characteristics specified in the BS-standards are illustrated in Fig. 3, 4, 5 and 6.

Note.

The actual operate time of the relay, presented in the graphs in Fig. 3...6, includes an additional filter and detection time plus the operate time of the trip output relay. When the operate time of the relay is calculated using the mathematical expression above, these additional times of about 30 ms in total have to be added to the time received.

RI-type characteristic

The RI-type characteristic is a special characteristic used mainly for time grading with existing mechanical relays. The characteristic is based on the following mathematical expression:

$$t [s] = k / (0.339 - 0.236 \times I > / I)$$

where t = operating time in seconds
 k = time multiplier
 I = phase current
 $I >$ = set starting current

The graph of the characteristic is shown in Fig.7.

RXIDG-type characteristic

The RXIDG-type characteristic is a special characteristic used mainly for earth-fault protection where a high degree of selectivity is needed also for high-resistance faults. With this characteristic, the protection need not to be directional and the scheme can operate without a pilot communication.

The time / current characteristic can be expressed as:

$$t [s] = 5.8 - 1.35 \times \log_e (I / (k \times I >))$$

where t = operating in seconds
 k = time multiplier
 I = phase current
 $I >$ = set starting current

Note!

If the setting is higher than $2.5 \times I_n$, the maximum continuous carry ($3 \times I_n$) and the levelling out of the IDMT-curves at high current levels must be noted.

Note!

The high-current end of any inverse time characteristic is determined by the high-set stage which, when started, inhibits the low-set stage operation. The trip time is thus equal to the set $t >>$ for any current higher than $I >>$. In order to get a trip signal, the stage $I >>$ must of course be linked to a trip output relay.

The graph of the characteristic is shown in Fig.8.

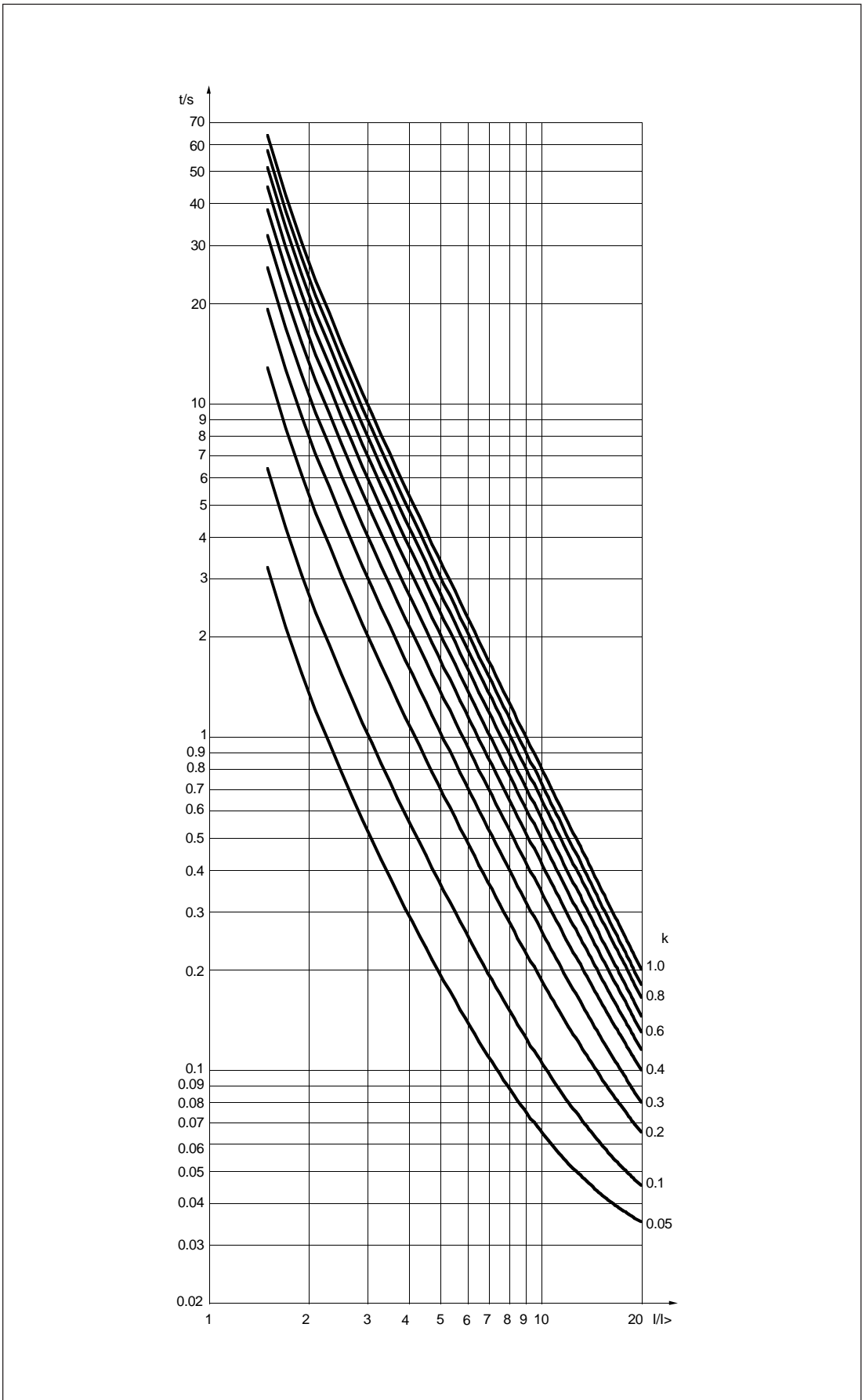

Fig. 3. Extremely inverse-time characteristics of the low-set overcurrent unit in relay module SPCJ 4D24

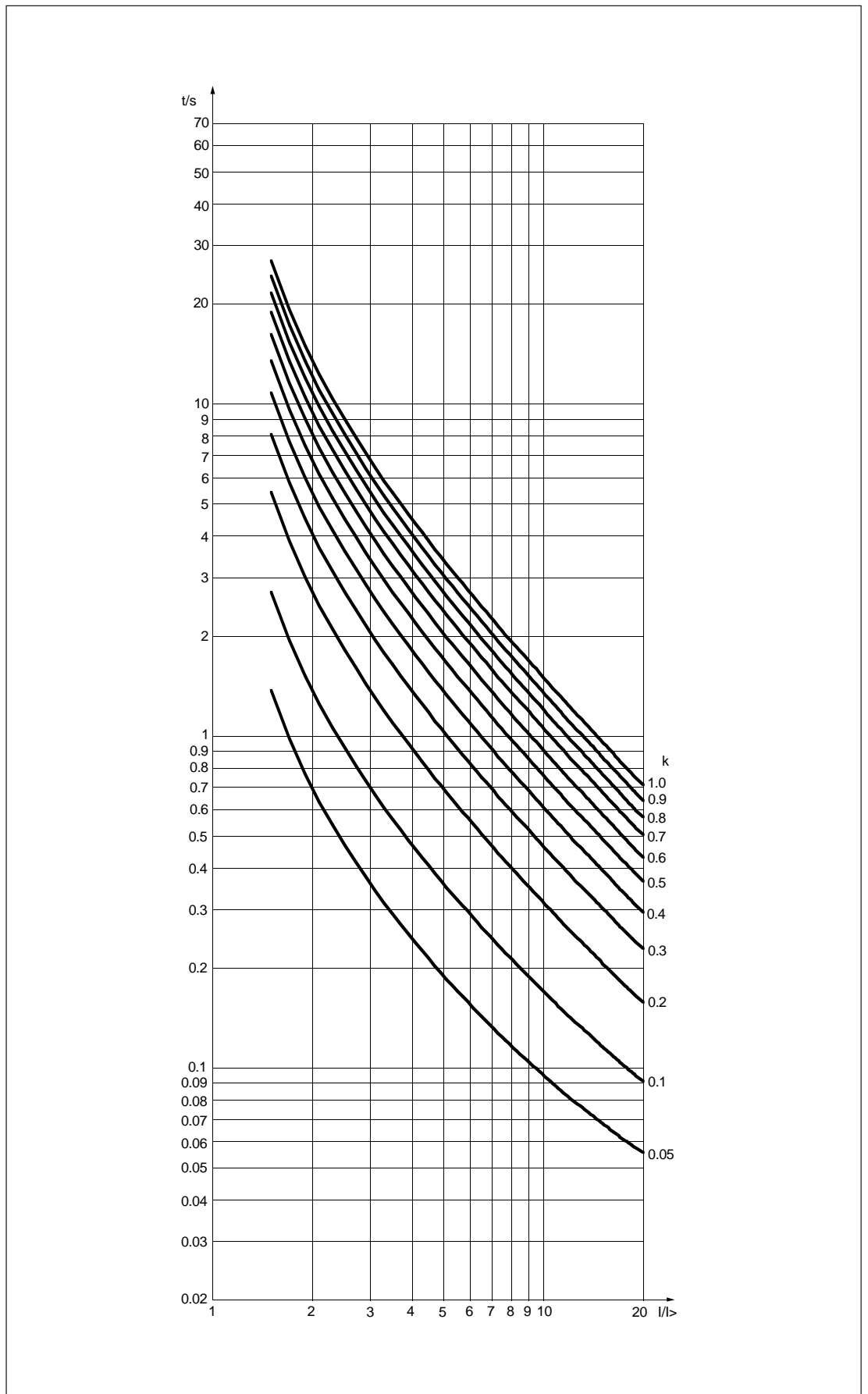

Fig. 4. Very inverse-time characteristics of the low-set overcurrent unit in relay module SPCJ 4D24

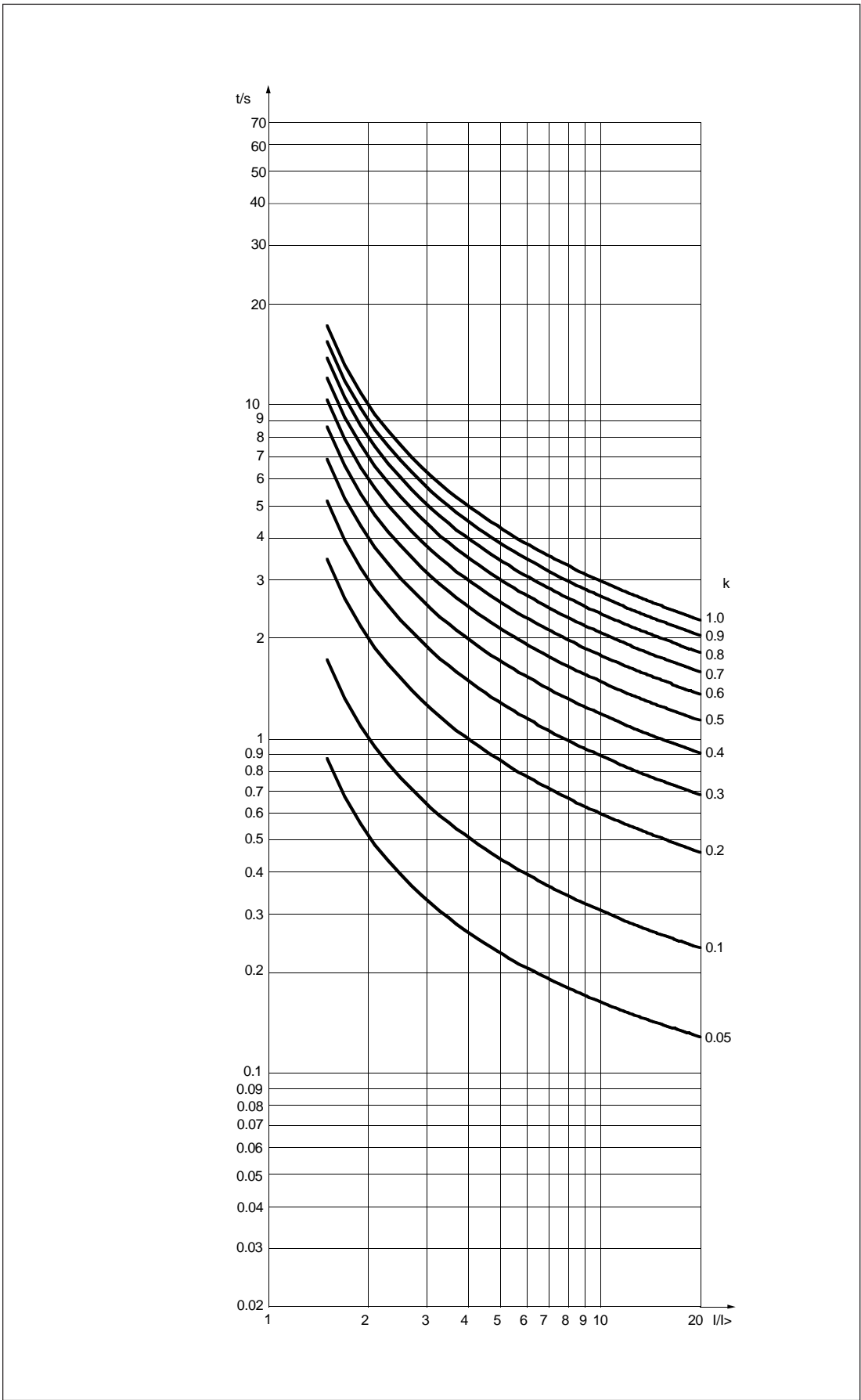

Fig. 5. Normal inverse-time characteristics of the low-set overcurrent unit in relay module SPCJ 4D24

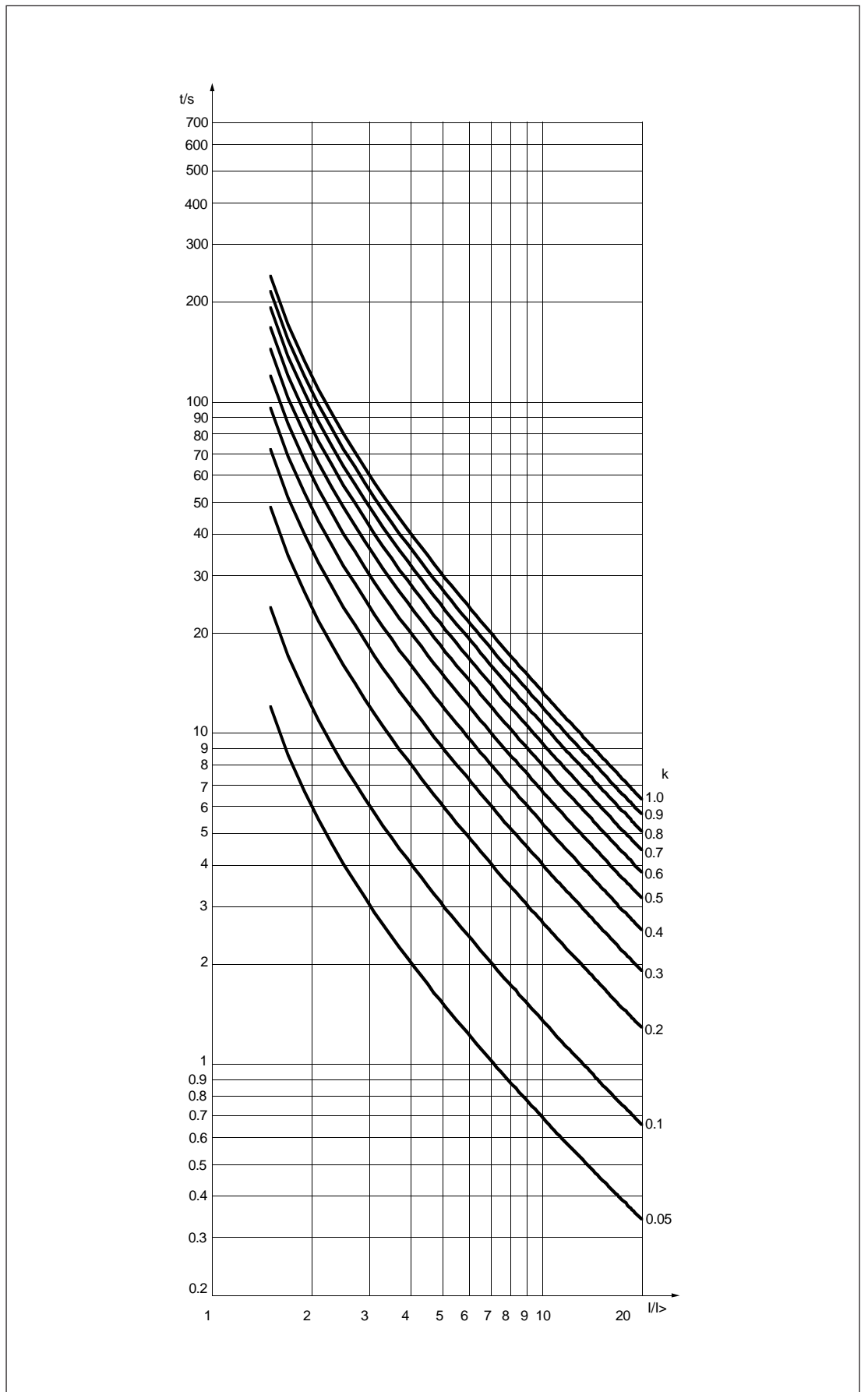

Fig. 6. Long-time inverse-time characteristics of the low-set overcurrent unit in relay module SPCJ 4D24

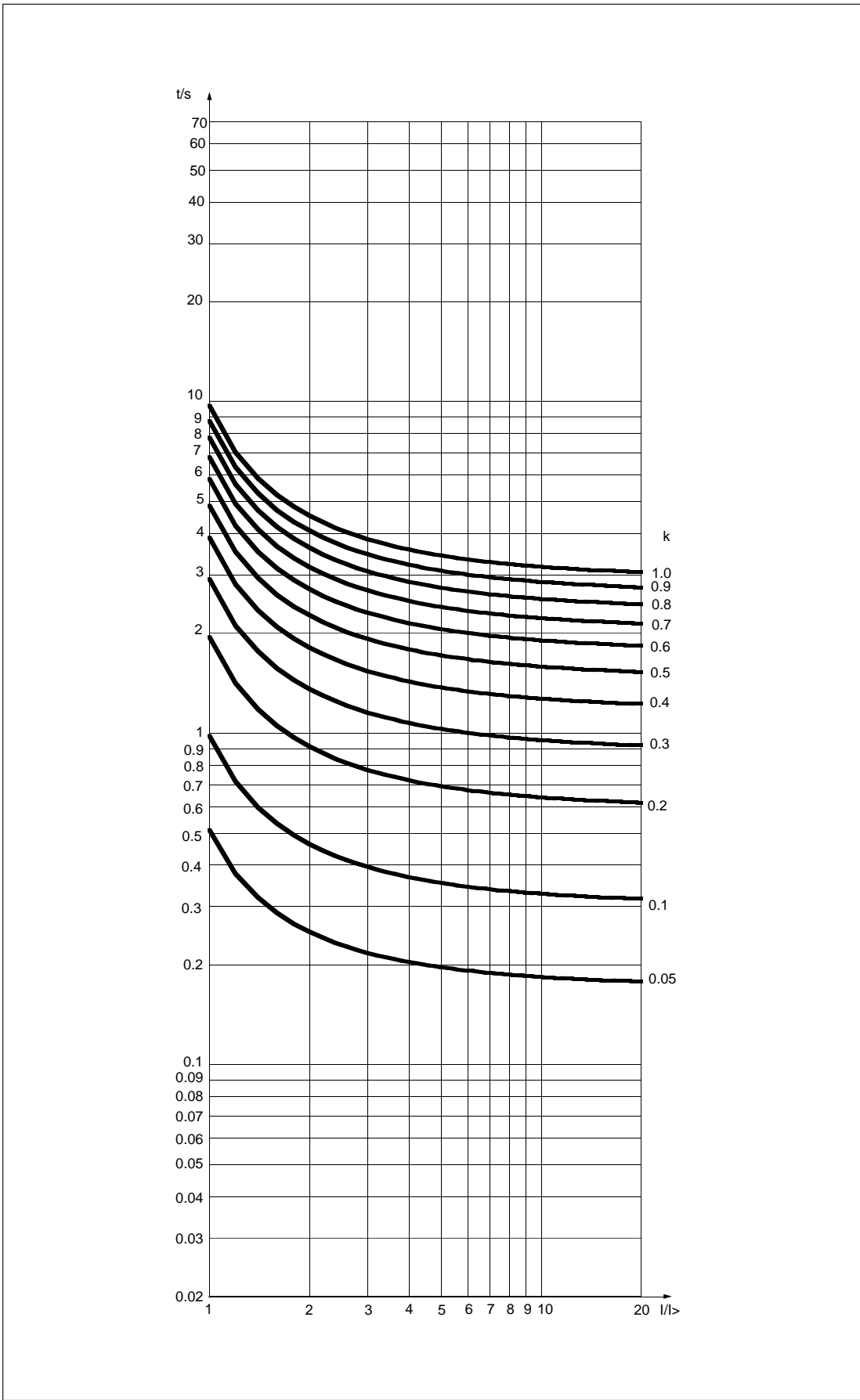

Fig. 7. RI-type inverse-time characteristics of the low-set overcurrent unit in relay module SPCJ 4D24

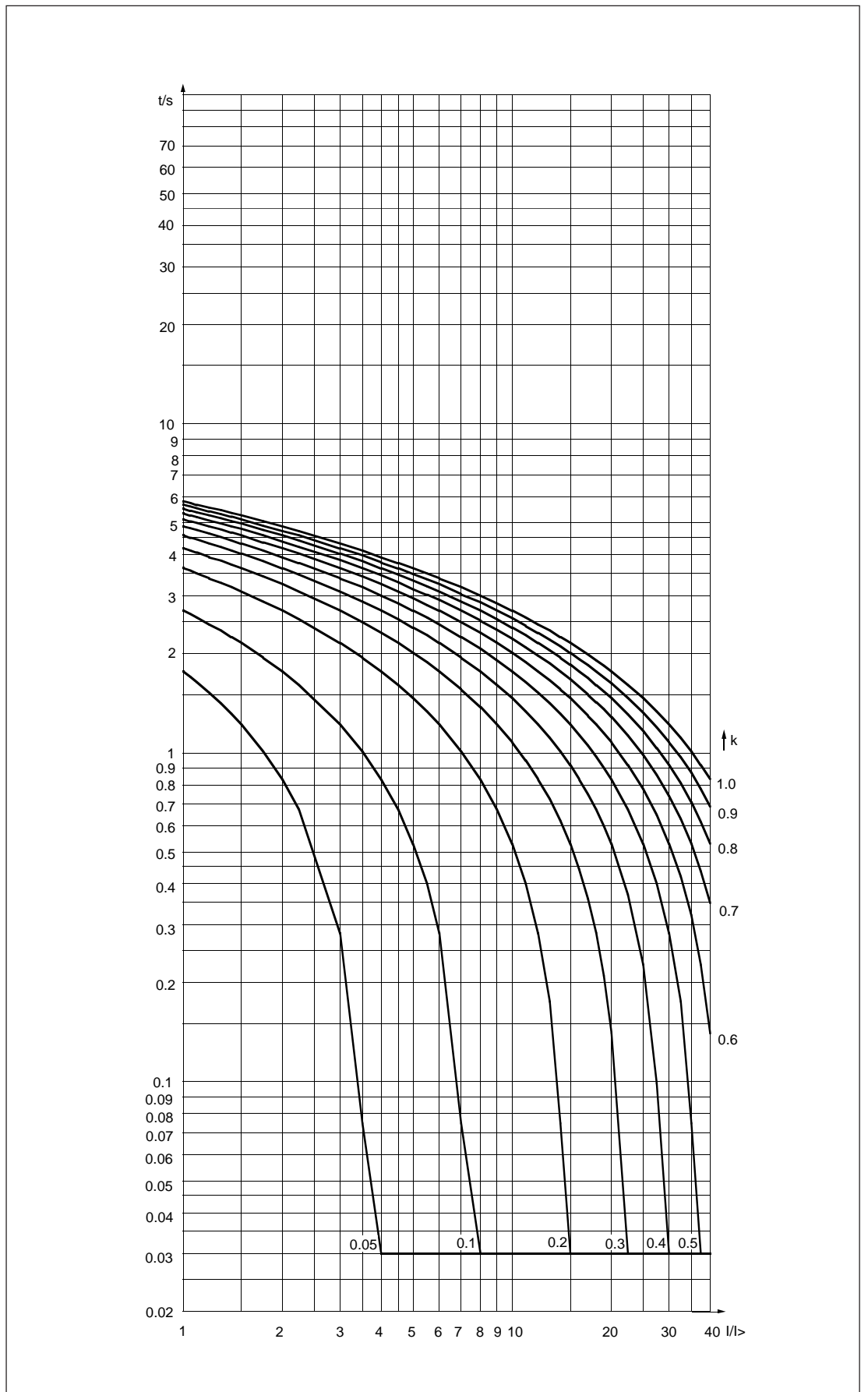

Fig. 8. RXIDG-type inverse-time characteristics of the low-set overcurrent unit in module SPCJ 4D24

Technical data**Low-set overcurrent stage I>**

Setting range	
- at definite time	0.5...5.0 x I _n
- at inverse time	0.5...2.5 x I _n
Starting time	< 70 ms
Operating time at definite time mode of operation	0.05...300 s
Operating characteristics at IDMT mode of operation	Extremely inverse Very inverse Normal inverse Long-time inverse RI-type inverse RXIDG-type inverse
Time multiplier k	0.05...1.00
Resetting time	< 80 ms
Retardation time	30 ms
Drop-off/pick-up ratio, typically	0.96
Operation time accuracy at definite time mode of operation	± 2 % of set value or ± 25 ms
Operation time accuracy class E at inverse time mode of operation	5
Operation accuracy	± 3 % of set value

High-set overcurrent stage I>>

Setting range	0.5...40.0 x I _n or ∞, infinite
Starting time, typically	40 ms
Operating time	0.04...300 s
Resetting time	< 80 ms
Retardation time	30 ms
Drop-off/pick-up ratio, typically	0.96
Operation time accuracy	± 2 % of set value or ± 25 ms
Operation accuracy	± 3 % of set value

Low-set neutral overcurrent stage I₀>

Setting range	1.0...25.0 % I _n
Starting time	< 70 ms
Operation time	0.05...300 s
Resetting time	< 80 ms
Drop-off/pick-up ratio, typically	0.96
Operation time accuracy	± 2 % of set value or ± 25 ms
Operation accuracy	± 4 % of set value

High-set neutral overcurrent stage I₀>>

Setting range	2.0...200 % I _n or ∞, infinite
Starting time, typically	50 ms
Operation time	0.05...300 s
Resetting time	< 80 ms
Drop-off/pick-up ratio, typically	0.96
Operation time accuracy	± 2 % of set value or ± 25 ms
Operation accuracy	± 4 % of set value

Serial communication parameters

Event codes

When the overcurrent and earth-fault relay module SPCJ 4D24 is linked to the control data communicator SACO 148 D4 over a SPA bus, the module will provide spontaneous event markings e.g. to a printer. The events are printed out in the format: time, text which the user may have programmed into SACO 148 D4 and event code.

The codes E1...E16 and the events represented by these can be included in or excluded from the event reporting by writing an event mask V155 for the overcurrent events and V156 for earth-fault events to the module over the SPA bus. The event masks are binary numbers coded to decimal numbers. The event codes E1...E8 are represented by the numbers 1, 2, 4...128. An event mask is formed by multiplying the above numbers either by 0, event not included in reporting, or 1, event included in reporting and adding up the numbers received, compare the procedure used in calculation of a checksum.

The event masks V155 and V156 may have a value within range 0...255. The default value of the overcurrent and earth-fault relay module SPCJ 4D24 is 85 both for overcurrent and earth-fault events, which means that all startings and trippings are included in the reporting, but not the resetting.

The output signals are monitored by codes E17...E26 and the events represented by these can be included in or excluded from the event reporting by writing an event mask V157 to the

module. The event mask is a binary number coded to a decimal number. The event codes E17...E26 are represented by the numbers 1, 2, 4...512. An event mask is formed by multiplying the above numbers either by 0, event not included in reporting or 1, event included in reporting and adding up the numbers received, compare the procedure used in calculation of a checksum.

The event mask V157 may have a value within the range 0...1024. The default value of the overcurrent and earth-fault relay module SPCJ 4D24 is 768 which means that only the operations of the trip relay are included in the reporting.

The codes E50...E54 and the events represented by these cannot be excluded from the reporting.

An event buffer is capable of memorizing up to eight events. If more than eight events occur before the content of the buffer is sent to the communicator an overflow event "E51" is generated. This event has to be reset by writing a command "0" to parameter C over the SPA-bus.

More information about the serial communication over the SPA-bus can be found in the manual "SPA-BUS COMMUNICATION PROTOCOL", 34 SPACOM 2 EN1.

Event codes of the combined overcurrent and earth-fault relay module SPCJ 4D24:

Code	Event	Weight factor	Default value of the factor
E1	Starting of stage I>	1	1
E2	Starting of stage I> reset	2	0
E3	Tripping of stage I>	4	1
E4	Tripping of stage I> reset	8	0
E5	Starting of I>> stage	16	1
E6	Starting of I>> stage reset	32	0
E7	Tripping of stage I>>	64	1
E8	Tripping of stage I>> reset	128	0
Default checksum for mask V155			85

Code	Event	Weight factor	Default value of the factor
E9	Starting of stage I ₀ >	1	1
E10	Starting of stage I ₀ > reset	2	0
E11	Tripping of stage I ₀ >	4	1
E12	Tripping of stage I ₀ > reset	8	0
E13	Starting of I ₀ >> stage	16	1
E14	Starting of I ₀ >>stage reset	32	0
E15	Tripping of stage I ₀ >>	64	1
E16	Tripping of stage I ₀ >> reset	128	0
Default checksum for mask V156			85

E17	Output signal TS1 activated	1	0
E18	Output signal TS1 reset	2	0
E19	Output signal SS1 activated	4	0
E20	Output signal SS1 reset	8	0
E21	Output signal SS2 activated	16	0
E22	Output signal SS2 reset	32	0
E23	Output signal SS3 activated	64	0
E24	Output signal SS3 reset	128	0
E25	Output signal TS2 activated	256	1
E26	Output signal TS2 reset	512	1
Default checksum for mask V157			768

E50	Restarting	*	-
E51	Overflow of event register	*	-
E52	Temporary interruption in data communication	*	-
E53	No response from the module over the data communication	*	-
E54	The module responds again over the data communication	*	-

- 0 not included in the event reporting
- 1 included in the event reporting
- * no code number
- cannot be programmed

Note !

The event codes E52...E54 are only generated by the data communicator unit (SACO 100M, SRIO 1000M, etc.)

Data to be transferred over the serial bus

In addition to the spontaneous data transfer the SPA bus allows reading of all input data (I-data) of the module, setting values (S-values), information recorded in the memory (V-data), and some other data. Further, part of the data can be altered by commands given over the SPA bus.

All the data are available in channel 0.

R = data to be read from the unit
W = data to be written to the unit
(P) = writing enabled by a password

Data	Code	Data direction	Values
INPUTS			
Measured current on phase L1	I1	R	0...63 x I _n
Measured current on phase L2	I2	R	0...63 x I _n
Measured current on phase L3	I3	R	0...63 x I _n
Measured neutral current	I4	R	0...210 % I _n
Blocking or control signal	I5	R	0 = no blocking 1 = external blocking or control signal active
OUTPUTS			
Starting of stage I>	O1	R	0 = I> stage not started 1 = I> stage started
Tripping of stage I>	O2	R	0 = I> stage not tripped 1 = I> stage tripped
Starting of stage I>>	O3	R	0 = I>> stage not started 1 = I>> stage started
Tripping of stage I>>	O4	R	0 = I>> stage not tripped 1 = I>> stage tripped
Starting of stage I ₀ >	O5	R	0 = I ₀ > stage not started 1 = I ₀ > stage started
Tripping of stage I ₀ >	O6	R	0 = I ₀ > stage not tripped 1 = I ₀ > stage tripped
Starting of stage I ₀ >> started	O7	R	0 = I ₀ >> stage not started 1 = I ₀ >> stage started
Tripping of stage I ₀ >> tripped	O8	R	0 = I ₀ >> stage not tripped 1 = I ₀ >> stage tripped
Signal START1 TS1	O9	R, W (P)	0 = signal not active 1 = signal active
Signal START2 SS1	O10	R, W (P)	0 = signal not active 1 = signal active
Signal ALARM1 SS2	O11	R, W (P)	0 = signal not active 1 = signal active
Signal ALARM2 SS3	O12	R, W (P)	0 = signal not active 1 = signal active
Signal TRIP TS2	O13	R, W (P)	0 = signal not active 1 = signal active
Operate output relays	O41	R, W (P)	0 = not operated 1 = operated

Data	Code	Data direction	Values
Memorized I> start	O21	R	0 = signal not active 1 = signal active
Memorized I> trip	O22	R	0 = signal not active 1 = signal active
Memorized I>> start	O23	R	0 = signal not active 1 = signal active
Memorized I>> trip	O24	R	0 = signal not active 1 = signal active
Memorized I ₀ > start	O25	R	0 = signal not active 1 = signal active
Memorized I ₀ > trip	O26	R	0 = signal not active 1 = signal active
Memorized I ₀ >> start	O27	R	0 = signal not active 1 = signal active
Memorized I ₀ >> trip	O28	R	0 = signal not active 1 = signal active
Memorized output signal TS1	O29	R	0 = signal not active 1 = signal active
Memorized output signal SS1	O30	R	0 = signal not active 1 = signal active
Memorized output signal SS2	O31	R	0 = signal not active 1 = signal active
Memorized output signal SS3	O32	R	0 = signal not active 1 = signal active
Memorized output signal TS2	O33	R	0 = signal not active 1 = signal active

PRESENT SETTING VALUES

Present starting value for stage I>	S1	R	0.5...5.0 x I _n
Present operating time for stage I>	S2	R	0.05...300 s
Present starting value for stage I>>	S3	R	0.5...40 x I _n 999 = not in use (∞)
Present operating time for stage I>>	S4	R	0.04...300 s
Present starting value for stage I ₀ >	S5	R	1.0...25.0 % I _n
Present operating time for stage I ₀ >	S6	R	0.05...300 s
Present starting value for stage I ₀ >>	S7	R	2...200 % I _n 999 = not in use (∞)
Present operating time for stage I ₀ >>	S8	R	0.05...300 s
Present checksum of switchgroup SGF1	S9	R	0...255
Present checksum of switchgroup SGF2	S10	R	0...255
Present checksum of switchgroup SGB	S11	R	0...255
Present checksum of switchgroup SGR1	S12	R	0...255
Present checksum of switchgroup SGR2	S13	R	0...255
Present checksum of switchgroup SGR3	S14	R	0...255

Data	Code	Data direction	Values
MAIN SETTING VALUES			
Starting value for I> stage, main setting	S21	R, W (P)	0.5...5.0 x I _n
Operating time for I> stage, main setting	S22	R, W (P)	0.05...300 s
Starting value for I>> stage, main setting	S23	R, W (P)	0.5...40.0 x I _n
Operating time for I>> stage, main setting	S24	R, W (P)	0.04...300 s
Starting value for I ₀ > stage, main setting	S25	R, W (P)	1.0...25.0 % I _n
Operating time for I ₀ > stage, main setting	S26	R, W (P)	0.05...300 s
Starting value for I ₀ >> stage, main setting	S27	R, W (P)	2...200 % I _n
Operating time for I ₀ >> stage, main setting	S28	R, W (P)	0.05...300 s
Checksum of group SGF1, main setting	S29	R, W (P)	0...255
Checksum of group SGF2, main setting	S30	R, W (P)	0...255
Checksum of group SGB, main setting	S31	R, W (P)	0...255
Checksum of group SGR1, main setting	S32	R, W (P)	0...255
Checksum of group SGR2, main setting	S33	R, W (P)	0...255
Checksum of group SGR3, main setting	S34	R, W (P)	0...255
SECOND SETTING VALUES			
Starting value for I> stage, second setting	S41	R, W (P)	0.5...5.0 x I _n
Operating time for I> stage, second setting	S42	R, W (P)	0.05...300 s
Starting value for I>> stage, second setting	S43	R, W (P)	0.5...40.0 x I _n
Operating time for I>> stage, second setting	S44	R, W (P)	0.04...300 s
Starting value for I ₀ > stage, second setting	S45	R, W (P)	1.0...25.0 % I _n
Operating time for I ₀ > stage, second setting	S46	R, W (P)	0.05...300 s
Starting value for I ₀ >> stage, second setting	S47	R, W (P)	2...200 % I _n
Operating time for I ₀ >> stage, second setting	S48	R, W (P)	0.05...300 s
Checksum of group SGF1, second setting	S49	R, W (P)	0...255
Checksum of group SGF2, second setting	S50	R, W (P)	0...255
Checksum of group SGB, second setting	S51	R, W (P)	0...255
Checksum of group SGR1, second setting	S52	R, W (P)	0...255
Checksum of group SGR2, second setting	S53	R, W (P)	0...255
Checksum of group SGR3, second setting	S54	R, W (P)	0...255
Operation time for circuit breaker failure prot.	S61	R, W (P)	0.1...1.0 s

Data	Code	Data direction	Values
RECORDED AND MEMORIZED PARAMETERS			
Current in phase L1 at starting or tripping	V11...V51	R	0...63 x I _n
Current in phase L2 at starting or tripping	V12...V52	R	0...63 x I _n
Current in phase L3 at starting or tripping	V13...V53	R	0...63 x I _n
Netral current I ₀ at starting or tripping	V14...V54	R	0...210 % I _n
Duration of the latest starting situation of stage I>	V15...V55	R	0...100%
Duration of the latest starting situation of stage I>>	V16...V56	R	0...100%
Duration of the latest starting situation of stage I ₀ >	V17...V57	R	0...100%
Duration of the latest starting situation of stage I ₀ >>	V18...V58	R	0...100%
Maximum demand current for 15 min.	V1	R	0...2.5 x I _n
Number of startings of stage I>	V2	R	0...255
Number of startings of stage I>>	V3	R	0...255
Number of startings of stage I ₀ >	V4	R	0...255
Number of startings of stage I ₀ >>	V5	R	0...255
Phase conditions during trip	V6	R	1 = I _{L3} >, 2 = I _{L2} >, 4 = I _{L1} >, 8 = I ₀ > 16 = I _{L3} >>, 32 = I _{L2} >> 64 = I _{L1} >>, 128 = I ₀ >>
Operation indicator	V7	R	0...9
Highest maximum demand current 15 minute value	V8	R	0...2.55 x I _n
CONTROL PARAMETERS			
Resetting of output relays at self-holding	V101	W	1 = output relays and all information from the display are reset
Resetting of output relays and recorded data	V102	W	1 = output relays and registers are reset
Remote control of settings	V150	R, W	0 = main settings activated 1 = second settings activated, see section "Description of function"
Event mask word for overcurrent events	V155	R, W	0...255, see section "Event codes"
Event mask word for earth-fault events	V156	R, W	0...255, see section "Event codes"
Event mask word for output signal events	V157	R, W	0...1023, see section "Event codes"
Opening of password for remote settings	V160	W	1...999
Changing or closing of password for remote settings	V161	W (P)	0...999

Data	Code	Data direction	Values
Activating of self-supervision output	V165	W	1 = self-supervision output is activated and IRF LED turned on 0 = normal mode
EEPROM formatting	V167	W (P)	2 = formatted with a power reset for a fault code [53]
Internal error code	V 169	R	0...255
Data comm. address of the module	V200	R, W	1...254
Data transfer rate	V201	R, W	4,8 or 9,6 kBd (W) 4800 or 9600 Bd (R)
Programme version symbol	V205	R	042 _
Event register reading	L	R	time, channel number and event code
Re-reading of event register	B	R	time, channel number and event code
Type designation of the module	F	R	SPCJ 4D24
Reading of module status data	C	R	0 = normal state 1 = module been subject to automatic reset 2 = overflow of event regist. 3 = events 1 and 2 together
Resetting of module state data	C	W	0 = resetting
Time reading and setting	T	R, W	00.000...59.999 s

The event register can be read by L-command only once. Should a fault occur e.g. in the data transfer, the contents of the event register may be re-read using the B-command. When required, the B-command can be repeated. Generally, the control data communicator SACO 100M reads the event data and forwards them to the output device continuously. Under normal conditions the event register of the module is empty. In the same way the data communicator resets abnormal status data, so this data is normally a zero.

The setting values S1...S14 are the setting values used by the protection functions. These values are set either as the main settings and switch-group checksums S21...S34 or as the corresponding second settings S41...S54. All the settings can be read or written. A condition for writing is that remote set password has been opened.

When changing settings, the relay unit will check that the variable values are within the ranges specified in the technical data of the module. If a value beyond the limits is given to the unit, either manually or by remote setting, the unit will not perform the store operation but will keep the previous setting.

Fault codes

A short time after the internal self-supervision system has detected a permanent relay fault the red IRF indicator is lit and the output relay of the self-supervision system operates. Further, in most fault situations, an auto-diagnostic fault code is shown on the display. This fault code consists of a red figure 1 and a green code

number which indicates the fault type. When a fault code appears on the display, the code number should be recorded and given to the authorized repair shop when overhaul is ordered. In the table below some fault codes that might appear on the display of the SPCJ 4D24 module are listed:

Fault code	Type of error in module
4	Faulty trip relay path or missing output relay card
30	Faulty program memory (ROM)
50	Faulty work memory (RAM)
51	Parameter memory (EEPROM) block 1 faulty
52	Parameter memory (EEPROM) block 2 faulty
53	Parameter memory (EEPROM) block 1 and block 2 faulty
54	Parameter memory (EEPROM) block 1 and block 2 faulty with different checksums
56	Parameter memory (EEPROM) key faulty. Format by writing a "2" to variable V167
195	Too low value in reference channel with multiplier 1
131	Too low value in reference channel with multiplier 5
67	Too low value in reference channel with multiplier 25
203	Too high value in reference channel with multiplier 1
139	Too high value in reference channel with multiplier 5
75	Too high value in reference channel with multiplier 25
252	Faulty filter on Io channel
253	No interruptions from the A/D-converter



ABB Oy

Substation Automation

P.O.Box 699

FIN-65101 VAASA

Finland

Tel. +358 (0)10 22 11

Fax.+358 (0)10 22 41094

www.abb.com/substationautomation