

Honeywell

Honeywell Process Solutions

**Analog Input Module
2MLF-AV8A, AC8A
User's Guide**

ML200-AI
R200
September 2010

Release 200

Honeywell

Notices and Trademarks

**Copyright 2010 by Honeywell International Srl.
Release 200 September, 2010**

While this information is presented in good faith and believed to be accurate, Honeywell disclaims the implied warranties of merchantability and fitness for a particular purpose and makes no express warranties except as may be stated in its written agreement with and for its customers.

In no event is Honeywell liable to anyone for any indirect, special or consequential damages. The information and specifications in this document are subject to change without notice.

Honeywell, PlantScape, Experion PKS, and **TotalPlant** are registered trademarks of Honeywell International Inc.

Other brand or product names are trademarks of their respective owners.

Honeywell Process Solutions
1860 W. Rose Garden Lane
Phoenix, AZ 85027 USA
1-800 822-7673

About This Document

This document describes the procedure to install and configure the 2MLF-AV8A and AC8A; Analog to digital voltage and current converters.

Release Information

Document Name	Document ID	Release Number	Publication Date
2MLF-AV8A, AC8A User's Guide	ML200-AI	200	September 2010

References

The following list identifies all documents that may be source of reference for material discussed in this publication.

Document Title
SoftMaster User's Guide

Support and Other Contacts

United States and Canada

Contact: Honeywell Solution Support Center
Phone: 1-800-822-7673
Calls are answered by dispatcher between 6:00 am and 4:00 pm Mountain Standard Time. Emergency calls outside normal working hours are received by an answering service and returned within one hour.
Fascimile: 1-973-455-5000
Mail: Honeywell TAC, MS L17
1860 W. Garden Lane
Phoenix, AZ, 85027 USA

Europe, Middle East, and Africa (EMEA)

Contact: Honeywell TAC-EMEA
Phone: +32-2-728-2345
Fascimile: +32-2-728-2696
Mail: TAC-BE02
Hermes Plaza
Hermeslaan, 1H
B-1831 Diegem, Belgium

Pacific

Contact: Honeywell Global TAC – Pacific
Phone: 1300-364-822 (toll free within Australia)
+61-8-9362-9559 (outside Australia)
Fascimile: +61-8-9362-9564
Mail: Honeywell Limited Australia
5 Kitchener Way
Burswood 6100, Western Australia
Email: GTAC@honeywell.com

India

Contact: Honeywell Global TAC – India
Phone: +91-20- 6603-9400
Fascimile: +91-20- 6603-9800
Mail: Honeywell Automation India Ltd
56 and 57, Hadapsar Industrial Estate
Hadapsar, Pune –411 013, India
Email: Global-TAC-India@honeywell.com

Korea

Contact: Honeywell Global TAC – Korea
Phone: +82-2-799-6317
Fascimile: +82-2-792-9015
Mail: Honeywell Co., Ltd
4F, Sangam IT Tower
1590, DMC Sangam-dong, Mapo-gu
Seoul, 121-836, Korea
Email: Global-TAC-Korea@honeywell.com

People's Republic of China

Contact: Honeywell Global TAC – China
Phone: +86- 21-2219-6888
800-820-0237
400-820-0386
Mail: Honeywell (China) Co., Ltd
33/F, Tower A, City Center, 100 Zunyi Rd.
Shanghai 200051, People's Republic of China
Email: Global-TAC-China@honeywell.com

Singapore

Contact: Honeywell Global TAC – South East Asia
Phone: +65-6580-3500
Fascimile: +65-6580-3501
+65-6445-3033
Mail: Honeywell Private Limited
Honeywell Building
17, Changi Business Park Central 1
Singapore 486073
Email: GTAC-SEA@honeywell.com

Taiwan

Contact: Honeywell Global TAC – Taiwan
Phone: +886-7-536-2567
Fascimile: +886-7-536-2039
Mail: Honeywell Taiwan Ltd.
17F-1, No. 260, Jhongshan 2nd Road.
Cianjhen District
Kaohsiung, Taiwan, ROC
Email: Global-TAC-Taiwan@honeywell.com

Japan

Contact: Honeywell Global TAC – Japan
Phone: +81-3-6730-7160
Fascimile: +81-3-6730-7228

Support and Other Contacts

Mail: Honeywell Japan Inc.
New Pier Takeshiba, South Tower Building,
20th Floor, 1-16-1 Kaigan, Minato-ku,
Tokyo 105-0022, Japan
Email: Global-TAC-JapanJA25@honeywell.com

Elsewhere

Call your nearest Honeywell office.

World Wide Web

Honeywell Solution Support Online:

<http://www.honeywell.com/ps>







Training Classes





Honeywell Automation College:

<http://www.automationcollege.com>

Symbol Definitions

The following table lists the symbols used in this document to denote certain conditions.

Symbol	Definition
	ATTENTION: Identifies information that requires special consideration.
	TIP: Identifies advice or hints for the user, often in terms of performing a task.
	REFERENCE -EXTERNAL: Identifies an additional source of information outside of the bookset.
	REFERENCE - INTERNAL: Identifies an additional source of information within the bookset.
CAUTION	Indicates a situation which, if not avoided, may result in equipment or work (data) on the system being damaged or lost, or may result in the inability to properly operate the process.
	CAUTION: Indicates a potentially hazardous situation which, if not avoided, may result in minor or moderate injury. It may also be used to alert against unsafe practices. CAUTION symbol on the equipment refers the user to the product manual for additional information. The symbol appears next to required information in the manual.
	WARNING: Indicates a potentially hazardous situation, which, if not avoided, could result in serious injury or death. WARNING symbol on the equipment refers the user to the product manual for additional information. The symbol appears next to required information in the manual.
	WARNING, Risk of electrical shock: Potential shock hazard where HAZARDOUS LIVE voltages greater than 30 Vrms, 42.4 Vpeak, or 60 VDC may be accessible.

Symbol	Definition
	ESD HAZARD: Danger of an electro-static discharge to which equipment may be sensitive. Observe precautions for handling electrostatic sensitive devices.
	Protective Earth (PE) terminal: Provided for connection of the protective earth (green or green/yellow) supply system conductor.
	Functional earth terminal: Used for non-safety purposes such as noise immunity improvement. NOTE: This connection shall be bonded to Protective Earth at the source of supply in accordance with national local electrical code requirements.
	Earth Ground: Functional earth connection. NOTE: This connection shall be bonded to Protective Earth at the source of supply in accordance with national and local electrical code requirements.
	Chassis Ground: Identifies a connection to the chassis or frame of the equipment shall be bonded to Protective Earth at the source of supply in accordance with national and local electrical code requirements.

Contents

1. INTRODUCTION	15
1.1 Overview	15
1.2 Features	15
1.3 Terminology	17
Analog value- A.....	17
Digital value - D.....	17
Characteristics of A/D conversion	19
2. SPECIFICATIONS.....	21
2.1 Performance specifications	21
2.2 Part names and functions	24
2.3 Characteristics of I/O conversion.....	26
I/O characteristics of 2MLF-AV8A	27
I/O characteristics of 2MLF-AC8A	33
Accuracy	38
2.4 Functions	39
Functions of the input module	39
Sampling process.....	40
Filter process.....	40
Average process	42
Function to detect input signal failure/disconnect.....	44
3. INSTALLATION AND WIRING	47
3.1 Installation	47
Installation environment	47
Handling precautions	48
3.2 Wiring	49
Precautions for wiring.....	49
Wiring examples.....	49
4. OPERATING PROCEDURES AND MONITORING	53
4.1 Operating procedures.....	53

Contents
Symbol Definitions

4.2	Run parameters setting	54
	Setting items.....	54
	Setting I/O parameters	55
4.3	Special module monitoring	61
4.4	Register special module variables	65
	Registering special module variables	65
	Saving variables.....	66
	Program example with variable and address.....	66
5.	CONFIGURATION AND FUNCTION OF INTERNAL MEMORY.	69
5.1	Internal memory configuration	69
	Setting area of Run parameters	71
5.2	I/O area of A/D converted data	73
	Module Ready/Error (%UXa.b.0, %UXa.b.15; a: Base No., b: Slot No.)	73
	Run channel (%UXa.b.16~23, a: Base No., b: Slot No.)	73
	Digital output value (%UWa.b.2 ~9, a: Base No., b: Slot No.).....	73
	Detect input signal failure/disconnect flag (%UXa.b.160~167 a: Base No., b: Slot No.)	74
	Error clear request flag (%UXa.b.176, a: Base No., b: Slot No.)	75
5.3	Operation parameters settings area	76
	Address 0 - A/D conversion enable/disable status for each channel	76
	Address 1 - Input voltage/current range	76
	Address 2 - Output data format	79
	Address 4-11 - Filter constant	80
	Address 12 - Average process Enable/Disable	81
	Address 13 - Average process method (address number 13)	82
	Address 14-21 - Average value	82
	Error code (address number 22)	83
5.4	Global variable (data area)	85
	How to use global variable	85
	Local variable registration	85
	How to use local variables.....	87
5.5	PUT/GET function block use area (parameter area)	90
	PUT instruction.....	91
	GET instruction.....	93
	Example using PUT/GET instruction.....	94
	Output data range setting	97
6.	PROGRAMMING	107
6.1	Read/Write of operation parameter settings area	107
	Read operation parameters settings area (GET, GETP command)	107

Write operation parameters settings area (PUT, PUTP command).....	108
6.2 Configuring A/D module via program method	110
2MLF-AV8A.....	110
2MLF-AC8A	111
6.3 Basic program	113
2MLF-AV8A.....	113
2MLF-AC8A	116
6.4 Application program examples.....	120
Program to compare A/D conversion values	120
Program to output error codes of analog input module to BCD display.....	124
Program description	125
7. TROUBLESHOOTING	129
7.1 Error codes	129
7.2 Troubleshooting.....	131
RUN LED blinks	131
RUN LED is OFF.....	132
CPU module cannot read A/D conversion value	133
Mismatch between analog input value and digital output value.....	133
H/W error of A/D conversion module.....	134
Status check of A/D conversion module using System Monitor menu	134
8. APPENDIX	135
8.1 Appendix 1: Terminology	135
8.2 Appendix 2: External dimensions	138
External dimensions of 2MLF-AV8A/AC8A	138

Contents

Tables

Tables

Table 1 – Performance specifications	21
Table 2 – LED indications	25
Table 3 – Performance specifications	39
Table 4 – I/O parameter setting functions	54
Table 5 – I/O area of A/D converted data	69
Table 6 – Setting area of run parameters	71
Table 7 – List of error codes	129

Figures

Figure 1 – Analog value.....	17
Figure 2 – Example of transducer	17
Figure 3 – Digital value	18
Figure 4 – Process in PLC.....	18
Figure 5 – Characteristics of A/D conversion (voltage input)	19
Figure 6 – Characteristics of A/D conversion (current input).....	20
Figure 7 – Parts of 2MLF-AV8A and 2MLF-AC8A	24
Figure 8 – Accuracy.....	38
Figure 9 – Operating procedure	53
Figure 10 –Program example with variables and addresses	67

Contents
Figures

1. Introduction

1.1 Overview

This user's guide describes two analog input modules.

- 2MLF-AV8A type voltage to digital conversion module
- 2MLF-AC8A type current to digital conversion module.

Both A/D conversion modules are used for converting analog signals (voltage or current input) from PLC's external device to signed 16-bit binary data of digital value. They are used with MasterLogic-200 CPU module, ML200-IEC (2MLI-CPUU), and ML200R (2MLR-CPUH).

1.2 Features

1. Module selection: You can choose the module depending on input signal type.
 - a) 2MLF-AV8A: 8 channels, voltage input
 - b) 2MLF-AC8A: 8 channels, current input
2. High speed A/D conversion @ 250 μ s/channel.
3. High conversion accuracy of $\pm 0.2\%$ (ambient temperature of $25 \pm 5^\circ\text{C}$).
4. High resolution (16-bit) of digital value, that is, 1/16000.
5. Simplified module setup/monitoring through GUI:

Setting up an A/D conversion module's operation parameters (that is, range, filter, and so on.) was traditionally a cumbersome process using repetitive sequences of ladder programs. This is now achieved using a user-friendly graphical user interface (GUI) in SoftMaster I/O Parameters. In addition, the A/D conversion value can also be easily monitored using the Special Module Monitoring function.

6. Multiple digital output data formats: Fours formats are available, as specified below:
 - a) Unsigned value: 0 ~ + 16000
 - b) Signed value: - 8000 ~ + 8000
 - c) Precise value: Refer to Performance specifications.
 - d) Percentile value: 0 ~ + 10000

1. Introduction

1.2. Features

7. Detecting input signal failure/disconnect: Applicable only when analog input range of 1 ~ 5V (or 4 ~ 20mA) is used.

1.3 Terminology

Analog value- A

The analog value of the physical measurement is continuously displayed as numerical value. Since the analog value changes continuously, an instantaneous value is given as an input. It could be a measurement of any physical parameter, such as voltage, current, temperature, speed, pressure or flow.

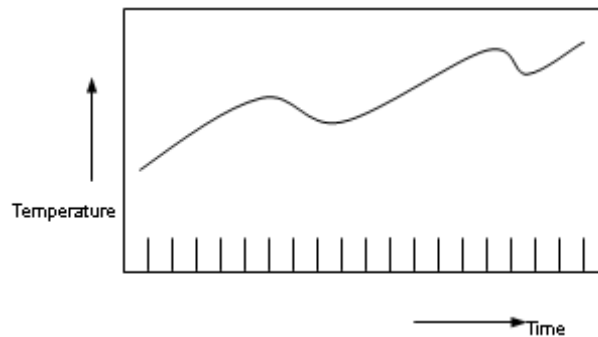

Figure 1 – Analog value

For example, temperature could be changing continuously with respect to time, as shown in Figure 1.

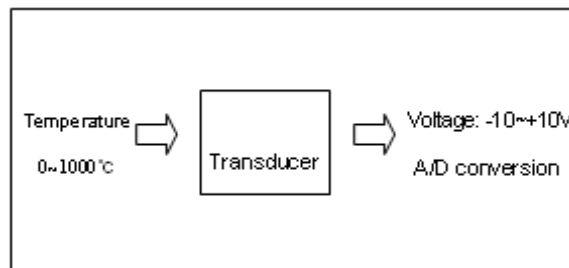

Figure 2 – Example of transducer

Since the changing temperature cannot be directly provide as an input to the A/D converter, it needs to be converted into voltage using a transducer and then provided.

Digital value - D

In a digital electronic circuit, data is processed and saved in the form of numbers 0 and 1 only. The data is processed as a string of 0s and 1s. For example, ON and OFF signals

1. Introduction
1.3. Terminology

can be displayed as 0 and 1, respectively, in a digital system. This is called as the binary numbering system. Decimals stored in binary numbering systems are called binary coded decimals (BCD). Figure 3 displays the digital value of the physical parameter.

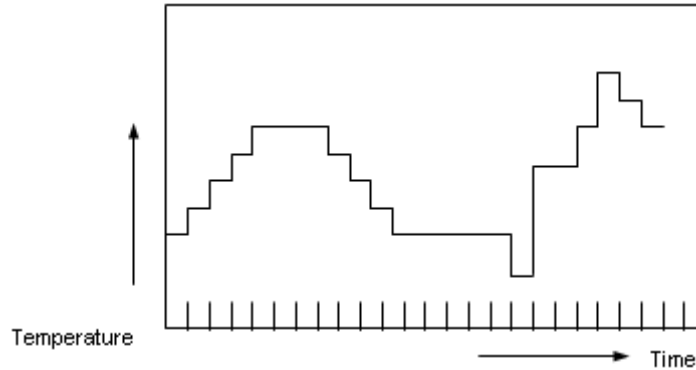

Figure 3 – Digital value

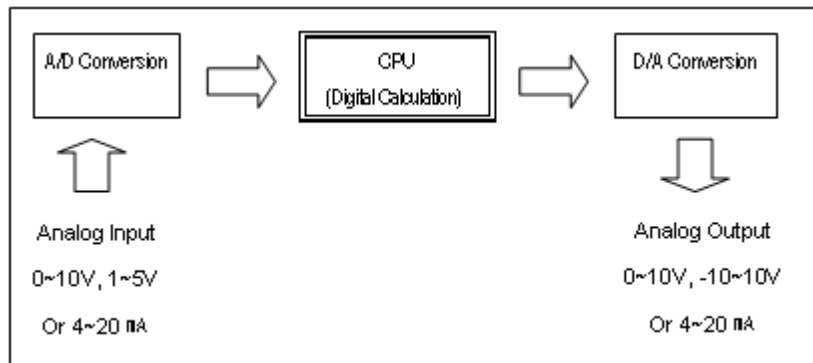

Figure 4 – Process in PLC

As the PLC processes only binary numbers, analog values cannot be directly input to the PLC's CPU for calculation. Conversion from analog to digital (as shown in Figure 4) is required. This is done using Analog to Digital converter (A/D conversion module).

Similarly, to get an analog output from a digital value, a Digital to Analog converter (D/A conversion module) is used.

Characteristics of A/D conversion

Voltage input

A/D conversion module is used for converting analog electric signal input from the external device to digital value. Analog input signal converted to digital value can be processed by the PLC's CPU. If analog input range of $-10 \sim 10\text{V}$ is used in voltage type of A/D conversion module, -10V of analog input corresponds to output of digital value 0. Analog input of $+10\text{V}$ corresponds to output digital value of 16000. This means, an analog input of 1.25mV represents digital value of 1, as shown in Figure 5.

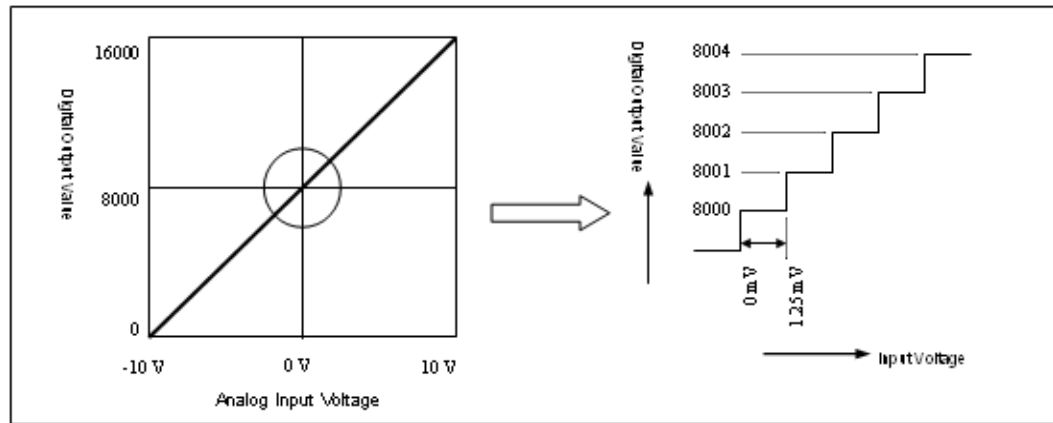

Figure 5 – Characteristics of A/D conversion (voltage input)

Current input

If analog input range of $0 \sim 20\text{mA}$ is used in current type of A/D conversion module, the 0mA of analog input corresponds to the output of digital value of 0. Analog input of 20mA corresponds to the output digital value of 16000. This means analog input of $1.25\mu\text{A}$ represents digital value of 1 (Figure 6).

1. Introduction
1.3. Terminology

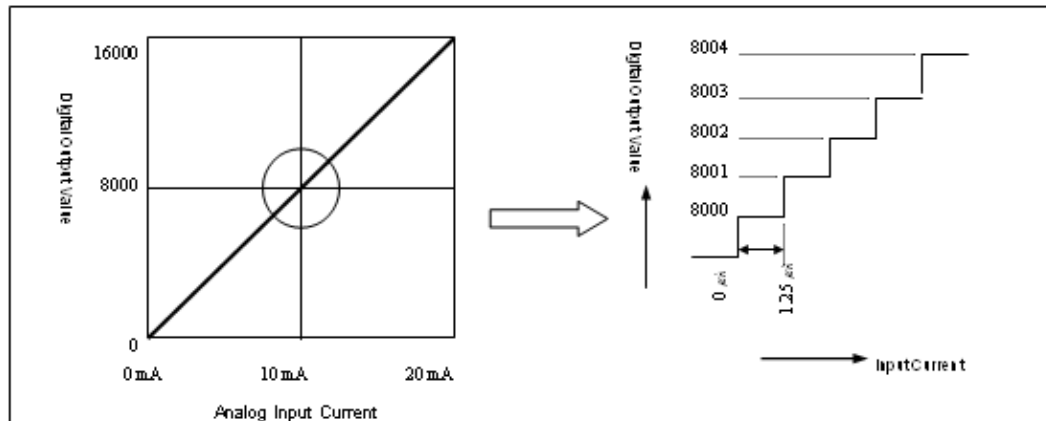

Figure 6 – Characteristics of A/D conversion (current input)

2. Specifications

2.1 Performance specifications

Table 1 specifies the performance specifications of A/D conversion modules.

Table 1 – Performance specifications

Item	Specifications																																							
	2MLF-AV8A (Voltage Input Type)		2MLF-AC8A (Current Input Type)																																					
Analog input	DC 1 ~ 5V DC 0 ~ 5V DC 0 ~ 10V DC -10 ~ 10V (Input Resistance: 1 MΩ minimum)		DC 4 ~ 20mA DC 0 ~ 20mA (Input Resistance 250Ω)																																					
Analog input range setting	You can select the analog input range individually for each channel either from user program or through user-friendly GUI I/O parameter function in SoftMaster.																																							
Digital value	(1) Voltage Type																																							
	<table border="1"> <tr> <td> <table border="1"> <tr> <td>Analog input</td> <td>1 ~ 5V</td> <td>0 ~ 5V</td> <td>0 ~ 10V</td> <td>-10 ~ 10V</td> </tr> <tr> <td>Digital output</td> <td></td> <td></td> <td></td> <td></td> </tr> </table> </td> <td></td> <td></td> <td></td> <td></td> </tr> <tr> <td>Unsigned value</td> <td colspan="4">0 ~ 16000</td> </tr> <tr> <td>Signed value</td> <td colspan="4">-8000 ~ 8000</td> </tr> <tr> <td>Precise value</td> <td>1000 ~ 5000</td> <td>0 ~ 5000</td> <td>0 ~ 10000</td> <td>-10000 ~ 10000</td> </tr> <tr> <td>Percentile value</td> <td colspan="4">0 ~ 10000</td> </tr> </table>	<table border="1"> <tr> <td>Analog input</td> <td>1 ~ 5V</td> <td>0 ~ 5V</td> <td>0 ~ 10V</td> <td>-10 ~ 10V</td> </tr> <tr> <td>Digital output</td> <td></td> <td></td> <td></td> <td></td> </tr> </table>	Analog input	1 ~ 5V	0 ~ 5V	0 ~ 10V	-10 ~ 10V	Digital output									Unsigned value	0 ~ 16000				Signed value	-8000 ~ 8000				Precise value	1000 ~ 5000	0 ~ 5000	0 ~ 10000	-10000 ~ 10000	Percentile value	0 ~ 10000							
	<table border="1"> <tr> <td>Analog input</td> <td>1 ~ 5V</td> <td>0 ~ 5V</td> <td>0 ~ 10V</td> <td>-10 ~ 10V</td> </tr> <tr> <td>Digital output</td> <td></td> <td></td> <td></td> <td></td> </tr> </table>	Analog input	1 ~ 5V	0 ~ 5V	0 ~ 10V	-10 ~ 10V	Digital output																																	
	Analog input	1 ~ 5V	0 ~ 5V	0 ~ 10V	-10 ~ 10V																																			
	Digital output																																							
	Unsigned value	0 ~ 16000																																						
	Signed value	-8000 ~ 8000																																						
	Precise value	1000 ~ 5000	0 ~ 5000	0 ~ 10000	-10000 ~ 10000																																			
	Percentile value	0 ~ 10000																																						
	(2) Current Type																																							
<table border="1"> <tr> <td> <table border="1"> <tr> <td>Analog input</td> <td>4 ~ 20mA</td> <td>0 ~ 20mA</td> </tr> <tr> <td>Digital value</td> <td></td> <td></td> </tr> </table> </td> <td></td> <td></td> </tr> <tr> <td>Unsigned value</td> <td colspan="2">0 ~ 16000</td> </tr> </table>	<table border="1"> <tr> <td>Analog input</td> <td>4 ~ 20mA</td> <td>0 ~ 20mA</td> </tr> <tr> <td>Digital value</td> <td></td> <td></td> </tr> </table>	Analog input	4 ~ 20mA	0 ~ 20mA	Digital value					Unsigned value	0 ~ 16000																													
<table border="1"> <tr> <td>Analog input</td> <td>4 ~ 20mA</td> <td>0 ~ 20mA</td> </tr> <tr> <td>Digital value</td> <td></td> <td></td> </tr> </table>	Analog input	4 ~ 20mA	0 ~ 20mA	Digital value																																				
Analog input	4 ~ 20mA	0 ~ 20mA																																						
Digital value																																								
Unsigned value	0 ~ 16000																																							

2. Specifications

2.1. Performance specifications

Item	Specifications			
	2MLF-AV8A (Voltage Input Type)		2MLF-AC8A (Current Input Type)	
	Signed value	-8000 ~ 8000		
	Precise value	4000 ~ 20000	0 ~ 20000	
	Percentile value	0 ~ 10000		
	<ul style="list-style-type: none"> 16-bit binary value (data: 14 bits) You can individually set the format of digital output data for each channel either from user program or through user-friendly GUI I/O parameter function in SoftMaster. 			
Maximum resolution	Analog input range	Resolution (1/16000)	Analog input range	Resolution (1/16000)
	1 ~ 5V	0.250mV	4 ~ 20mA	1.0μA
	0 ~ 5V	0.3125mV		
	0 ~ 10V	0.625mV	0 ~ 20mA	1.25μA
	-10 ~ 10V	1.250mV		
Accuracy	±0.2% or less (when ambient temperature is 25 ±5°C) ±0.3% or less (when ambient temperature is 0 ~ 55°C)			
Maximum conversion speed	250μs/channel			
Absolute maximum input	±15V		±30mA	
Analog input channels	8 channels/ module			
Isolation method	Photo-coupler isolation between input terminal and PLC power (no isolation between channels)			
Terminal connected	18-point terminal			
I/O addresses assigned	Fixed type: 64 points, Variable type: 16 points			

2. Specifications
2.1. Performance specifications

Item	Specifications	
	2MLF-AV8A (Voltage Input Type)	2MLF-AC8A (Current Input Type)
Internal-consumed current	DC 5V: 420mA	
Weight	140g	



ATTENTION

- When A/D conversion module is released from the factory, Offset/Gain value is suitably tuned to work for all input ranges. You cannot modify these values.
 - Offset Value: Analog input value when digital output value is 0 with digital output format set to unsigned value.
 - Gain Value: Analog input value when digital output value is 16000 with digital output format set to unsigned value.
-

2. Specifications

2.2. Part names and functions

2.2 Part names and functions

The following example illustrates the parts of 2MLF-AV8A and 2MLF-AC8A modules respectively.

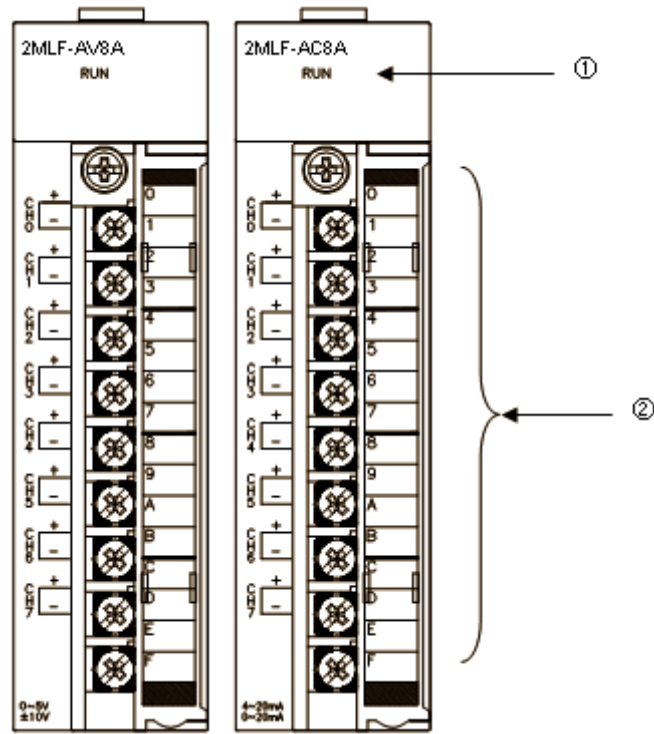

Figure 7 – Parts of 2MLF-AV8A and 2MLF-AC8A

Table 2 – LED indications

No.	Description
1	RUN LED Displays the operation status of 2MLF-AV8A/2MLF-AC8A <ul style="list-style-type: none">• On: Operation normal• Flickering: Error occurs (For more details, refer to section Error codes)• Off: DC 5V disconnected, 2MLF-AV8A/2MLF-AC8A module error
2	Terminal Analog input terminal, whose respective channels can be connected with external devices.

2. Specifications

2.3. Characteristics of I/O conversion

2.3 Characteristics of I/O conversion

Characteristics of I/O conversion is a straight line plotted between the Offset and Gain values when converting analog signal (voltage or current input) from PLC's external device to digital value. I/O conversion characteristics of A/D conversion modules are as follows.

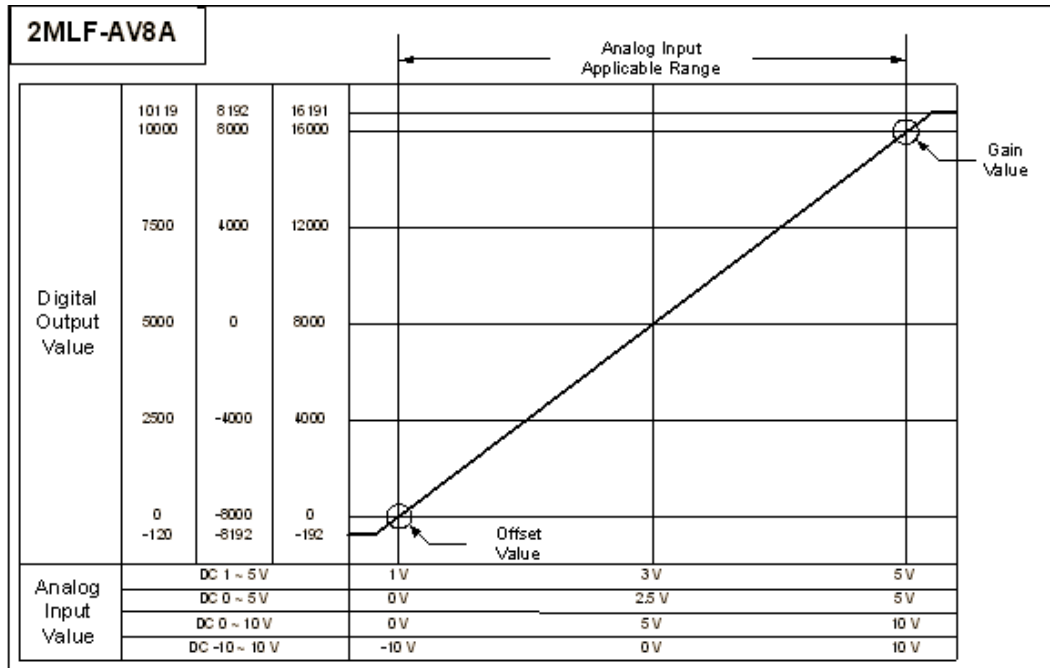

2. Specifications

2.3. Characteristics of I/O conversion

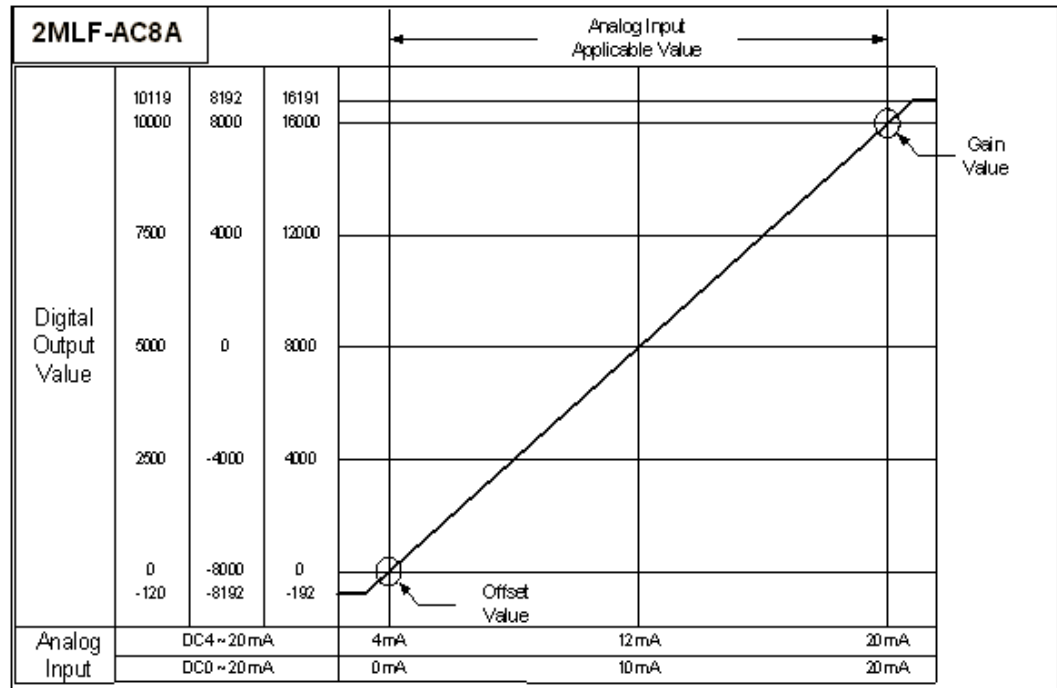

I/O characteristics of 2MLF-AV8A

2MLF-AV8A is a module exclusively used for 8-channel analog voltage input. The input range can be set from user program or special module package for respective channels. Output formats of digital data are as specified below:

- Unsigned value
- Signed value
- Precise value
- Percentile value

2. Specifications

2.3. Characteristics of I/O conversion

1. If the range is DC 1 ~ 5V

The digital output value for voltage input characteristics is as specified below:

(Resolution (based on 1/16000): 0.25mV) On the **I/O Parameters Setting** window, set **Input Range** to 1 ~ 5V.

Parameter	CH 0	CH 1	CH 2	CH 3	CH 4	CH 5	CH 6	CH 7
<input type="checkbox"/> Channel status	Disable	Disable	Disable	Disable	Disable	Disable	Disable	Disable
<input checked="" type="checkbox"/> Input range	1~5V	1~5V	1~5V	1~5V	1~5V	1~5V	1~5V	1~5V
Output type	0~16000	0~16000	0~16000	0~16000	0~16000	0~16000	0~16000	0~16000
<input type="checkbox"/> Filter process	Disable	Disable	Disable	Disable	Disable	Disable	Disable	Disable
Filter constant	1	1	1	1	1	1	1	1
<input type="checkbox"/> Average setting	Disable	Disable	Disable	Disable	Disable	Disable	Disable	Disable
<input type="checkbox"/> Average processing	Count-Avr	Count-Avr	Count-Avr	Count-Avr	Count-Avr	Count-Avr	Count-Avr	Count-Avr
Average value	2	2	2	2	2	2	2	2

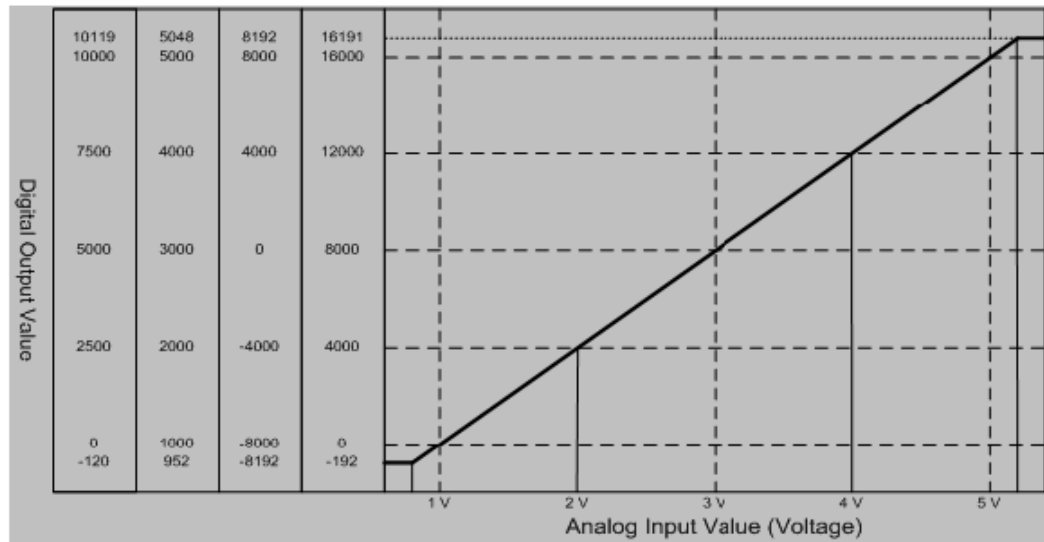

2. Specifications
2.3. Characteristics of I/O conversion

Digital output value for voltage input characteristics is as specified below.

(Resolution (based on 1/16000): 0.25mV)

Digital output range	Analog input voltage (V)						
	0.952	1	2	3	4	5	5.047
Unsigned value (-192 ~ 16191)	-192	0	4000	8000	12000	16000	16191
Signed value (-8192 ~ 8191)	-8192	-8000	-4000	0	4000	8000	8191
Precise value (952 ~ 5048)	952	1000	2000	3000	4000	5000	5048
Percentile value (-120 ~ 10119)	-120	0	2500	5000	7500	10000	10119

2. If the range is DC 0 ~ 5V

On the **I/O Parameters Setting** window, set **Input Range** to 0 ~ 5V.

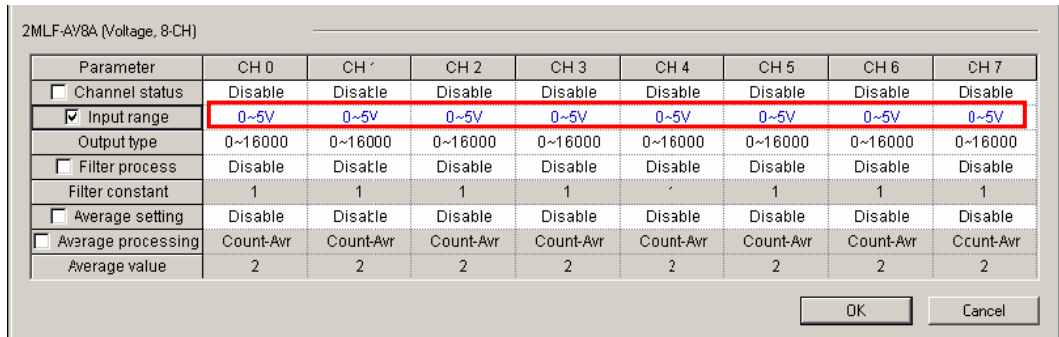

2. Specifications

2.3. Characteristics of I/O conversion

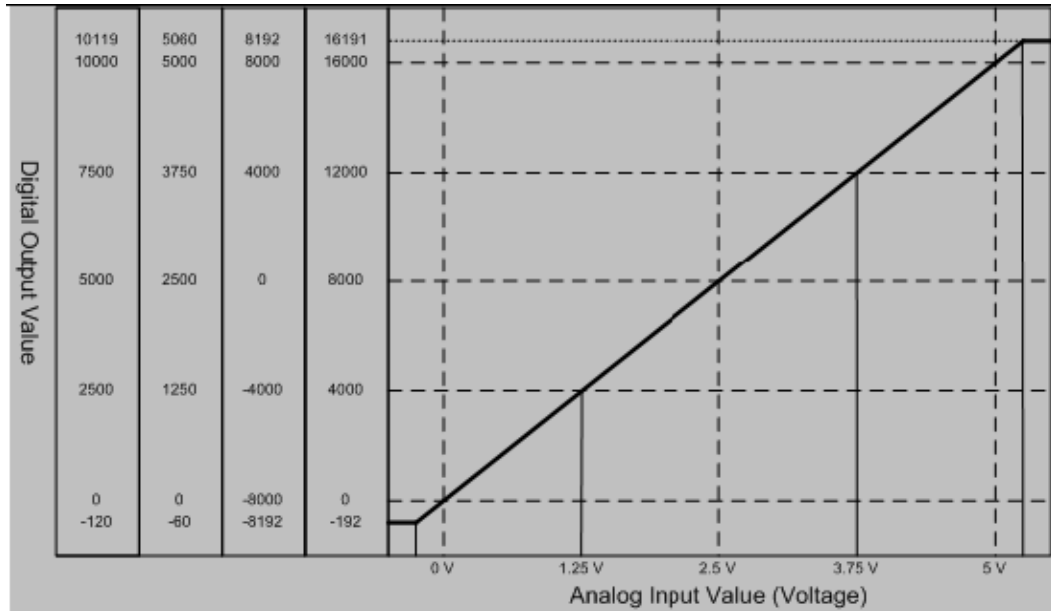

Digital output value for voltage input characteristics is as specified below.

(Resolution (based on 1/16000): 0.3125mV)

Digital output range	Analog input voltage (V)						
	-0.06	0	1.25	2.5	3.75	5	5.05
Unsigned value (-192 ~ 16191)	-192	0	4000	8000	12000	16000	16191
Signed value (-8192 ~ 8191)	-8192	-8000	-4000	0	4000	8000	8191
Precise value (-60 ~ 5060)	-60	0	1250	2500	3750	5000	5060
Percentile value (-120 ~ 10119)	-120	0	2500	5000	7500	10000	10119

3. If the range is DC 0 ~ 10V

2. Specifications
2.3. Characteristics of I/O conversion

On the **I/O Parameters Setting** window, set Input Range to 0 ~ 10V.

2MLF-AV8A (Voltage, 8-CH)

Parameter	CH 0	CH 1	CH 2	CH 3	CH 4	CH 5	CH 6	CH 7
<input type="checkbox"/> Channel status	Disable	Disable	Disable	Disable	Disable	Disable	Disable	Disable
<input checked="" type="checkbox"/> Input range	0~10V	0~10V	0~10V	0~10V	0~10V	0~10V	0~10V	0~10V
Output type	0~-16000	0~-16000	0~-16000	0~-16000	0~-16000	0~-16000	0~-16000	0~-16000
<input type="checkbox"/> Filter process	Disable	Disable	Disable	Disable	Disable	Disable	Disable	Disable
Filter constant	1	1	1	1	1	1	1	1
<input type="checkbox"/> Average setting	Disable	Disable	Disable	Disable	Disable	Disable	Disable	Disable
<input type="checkbox"/> Average processing	Count-Avr	Count-Avr	Count-Avr	Count-Avr	Count-Avr	Count-Avr	Count-Avr	Count-Avr
Average value	2	2	2	2	2	2	2	2

OK Cancel

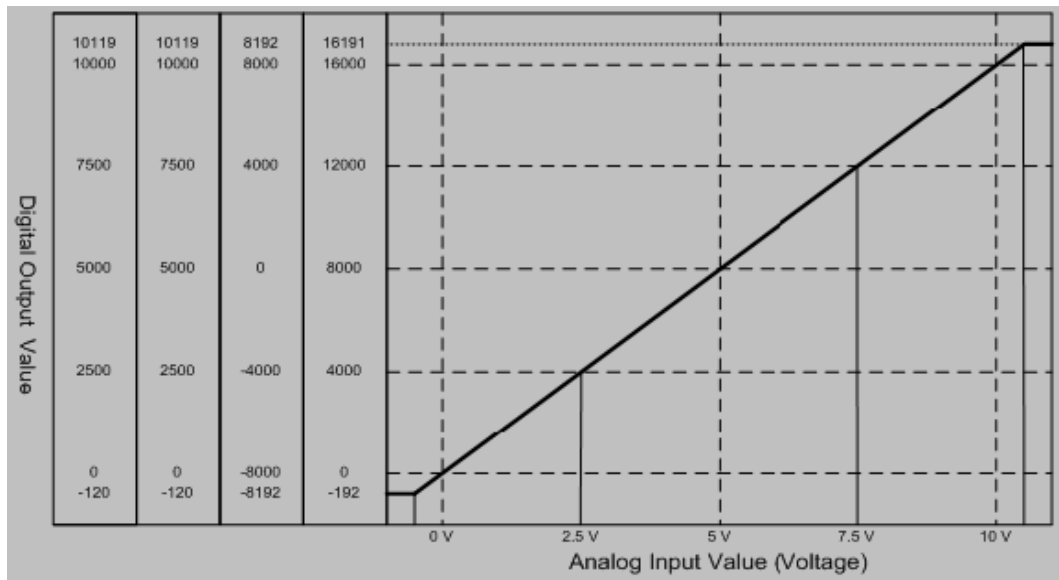

2. Specifications

2.3. Characteristics of I/O conversion

Digital output value for voltage input characteristics is as specified below:

(Resolution (based on 1/16000): 0.625mV)

Digital output range	Analog input voltage (V)						
	-0.12	0	2.5	5	7.5	10	10.11
Unsigned value (-192 ~ 16191)	-192	0	4000	8000	12000	16000	16191
Signed value (-8192 ~ 8191)	-8192	-8000	-4000	0	4000	8000	8191
Precise value (-60 ~ 5059)	-120	0	2500	5000	7500	10000	10119
Percentile value (-120 ~ 10119)	-120	0	2500	5000	7500	10000	10119

4. If the range is DC-10 ~ 10V

On I/O Parameters Setting window, set **Input Range** to -10 ~ 10V.

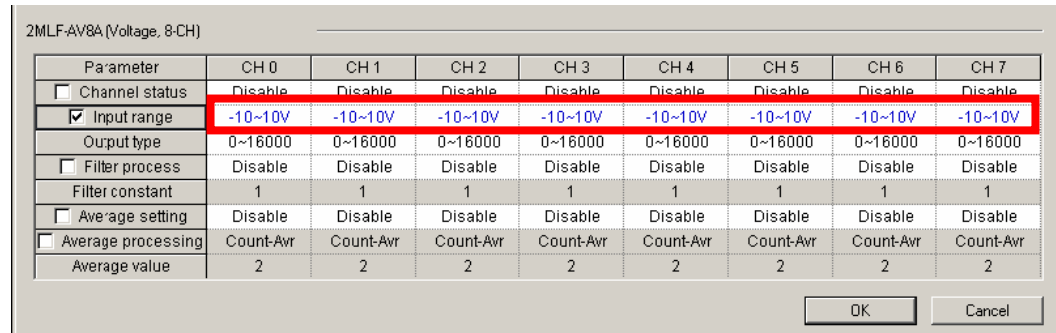

2. Specifications
2.3. Characteristics of I/O conversion

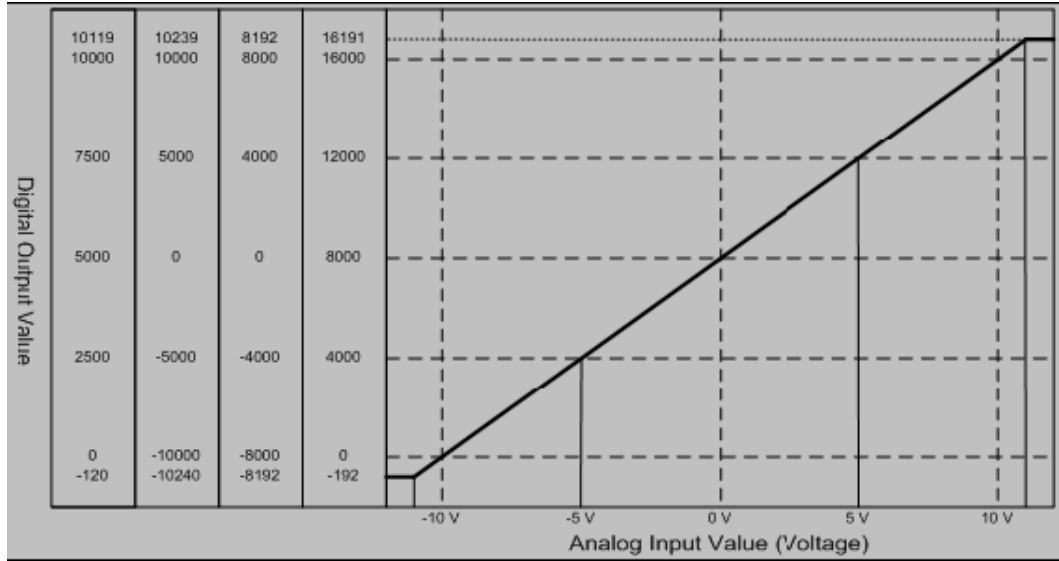

Digital output value for voltage input characteristics is as specified below.

(Resolution (based on 1/16000): 1.25mV)

Digital output range	Analog input voltage (V)						
	-0.24	-10	-5	0	5	10	10.23
Unsigned value (-192 ~ 16191)	-192	0	4000	8000	12000	16000	16191
Signed value (-8192 ~ 8191)	-8192	-8000	-4000	0	4000	8000	8191
Precise value (-10240 ~ 10238)	-10240	0	2500	5000	7500	10000	10239
Percentile value (-120 ~ 10119)	-120	0	2500	5000	7500	10000	10119

I/O characteristics of 2MLF-AC8A

You can set the current input range through user program or special module package for respective channels. Output formats of digital data are as specified below:

2. Specifications

2.3. Characteristics of I/O conversion

- Unsigned value
- Signed value
- Precise value
- Percentile value

1. If the range is DC 4 ~ 20mA

On I/O Parameters Setting window, set **Input Range** to 4 ~ 2mA.

2MLF-AC8A (Current, 8-CH)

Parameter	CH 0	CH 1	CH 2	CH 3	CH 4	CH 5	CH 6	CH 7
<input type="checkbox"/> Channel status	Disable	Disable	Disable	Disable	Disable	Disable	Disable	Disable
<input checked="" type="checkbox"/> Input range	4~20mA	4~20mA	4~20mA	4~20mA	4~20mA	4~20mA	4~20mA	4~20mA
Output type	0~16000	0~16000	0~16000	0~16000	0~16000	0~16000	0~16000	0~16000
<input type="checkbox"/> Filter process	Disable	Disable	Disable	Disable	Disable	Disable	Disable	Disable
Filter constant	1	1	1	1	1	1	1	1
<input type="checkbox"/> Average setting	Disable	Disable	Disable	Disable	Disable	Disable	Disable	Disable
<input type="checkbox"/> Average processing	Count-Avr	Count-Avr	Count-Avr	Count-Avr	Count-Avr	Count-Avr	Count-Avr	Count-Avr
Average value	2	2	2	2	2	2	2	2

OK Cancel

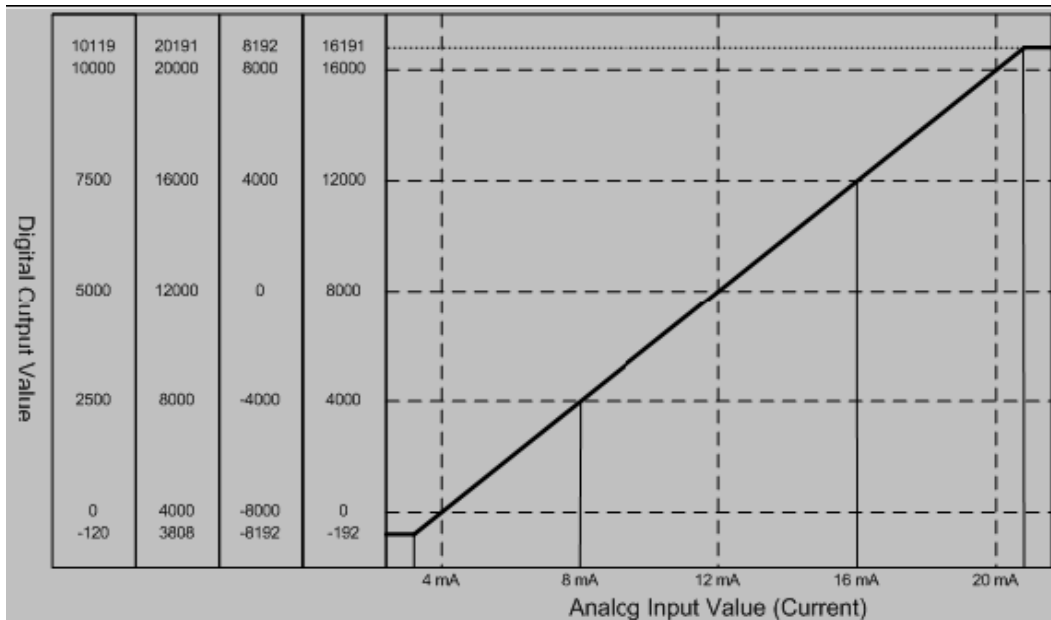

Digital output value for current input characteristics is as specified below:

(Resolution (based on 1/16000): 1 μ A)

Digital output range	Analog input current (mA)						
	3.808	4	8	12	16	20	20.191
Unsigned value (-192 ~ 16191)	-192	0	4000	8000	12000	16000	16191
Signed value (-8192 ~ 8191)	-8192	-8000	-4000	0	4000	8000	8191
Precise value (3808 ~ 20191)	3808	4000	8000	12000	16000	20000	20191
Percentile value (-120 ~ 10119)	-120	0	2500	5000	7500	10000	10119

2. Specifications

2.3. Characteristics of I/O conversion

2. If the range is DC 0 ~ 20mA

On the **I/O Parameters Setting** window, set **Input Range** to 0 ~ 20mA.

2MLF-AC8A (Current, 8-CH)

Parameter	CH 0	CH 1	CH 2	CH 3	CH 4	CH 5	CH 6	CH 7
<input type="checkbox"/> Channel status	Disable	Disable	Disable	Disable	Disable	Disable	Disable	Disable
<input checked="" type="checkbox"/> Input range	0~20mA	0~20mA	0~20mA	0~20mA	0~20mA	0~20mA	0~20mA	0~20mA
Output type	0~16000	0~16000	0~16000	0~16000	0~16000	0~16000	0~16000	0~16000
<input type="checkbox"/> Filter process	Disable	Disable	Disable	Disable	Disable	Disable	Disable	Disable
Filter constant	1	1	1	1	1	1	1	1
<input type="checkbox"/> Average setting	Disable	Disable	Disable	Disable	Disable	Disable	Disable	Disable
<input type="checkbox"/> Average processing	Count /avr	Count /avr	Count /avr	Count /avr	Count /avr	Count /avr	Count /avr	Count /avr
Average value	2	2	2	2	2	2	2	2

OK Cancel

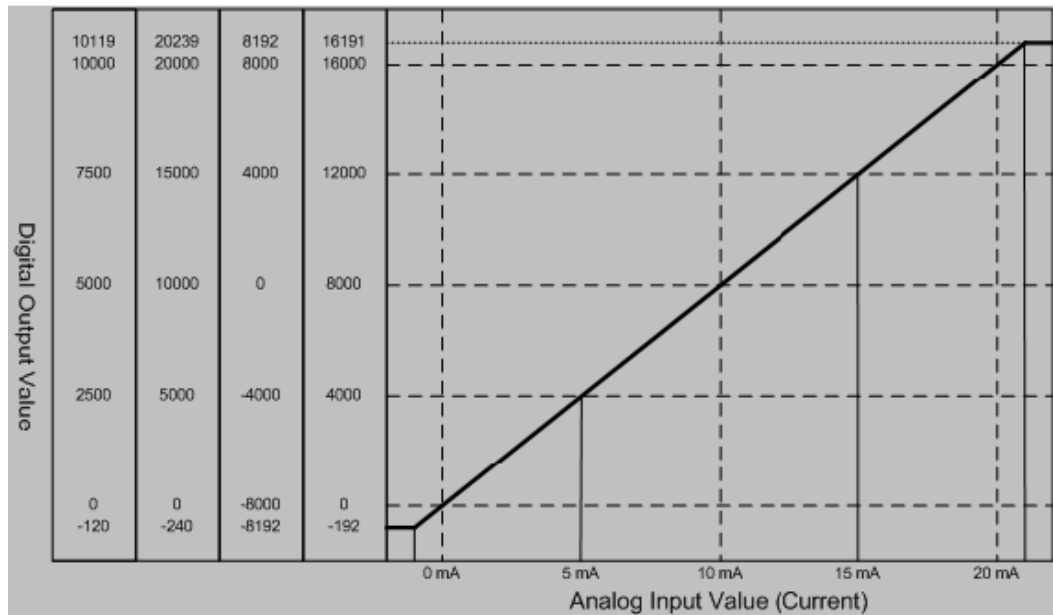

Digital output value for current input characteristics is as specified below:

(Resolution (based on 1/16000): 1.25 μ A)

Digital output range	Analog input current (mA)						
	-0.24	0	5	10	15	20	20.23
Unsigned value (-192 ~ 16191)	-192	0	4000	8000	12000	16000	16191
Signed value (-8192 ~ 8191)	-8192	-8000	-4000	0	4000	8000	8191
Precise value (3808 ~ 20191)	-240	0	5000	10000	15000	20000	20239
Percentile value (-120 ~ 10119)	-120	0	2500	5000	7500	10000	10119

-
- CAUTION**
1. If analog input value exceeds the maximum range (For example, 20mA), the digital value is fixed at maximum (For example, 16191 for unsigned) as per above table. Likewise, if analog input value drops below minimum range (For example, 0mA), the digital value is fixed at minimum (For example, -192 for unsigned) as per above table.
 2. Voltage and current input should not exceed $\pm 15V$ and $\pm 30mA$, respectively. Increase in temperature may lead to erratic reading.
 3. You cannot modify the Offset/Gain setting for 2MLF-AV8A/AC8A module.
-

2. Specifications

2.3. Characteristics of I/O conversion

Accuracy

Accuracy of digital output value does not change even if you change the input range. Figure 8 shows the change range of the accuracy at ambient temperature of $25 \pm 5^\circ\text{C}$ with analog input range as $-10 \sim 10\text{V}$ and digital output type as unsigned value. $\pm 0.2\%$ at ambient temperature of $25 \pm 5^\circ\text{C}$, and $\pm 0.3\%$ at ambient temperature of $0 \sim 55^\circ\text{C}$.

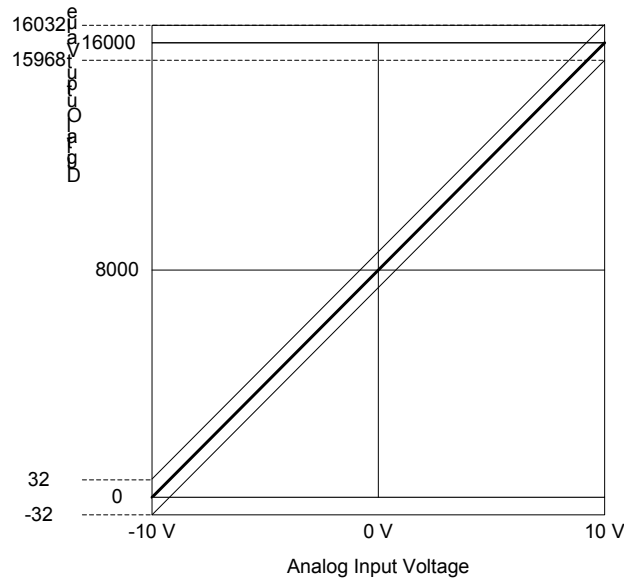

Figure 8 – Accuracy

2.4 Functions

Functions of the input module

Table 3 describes the functions of A/D conversion module.

Table 3 – Performance specifications

Function Item	Details
Channel Run/Stop setting	Specify Run/Stop of the channel to execute A/D conversion. If the unused channel is set to Stop, the Run time can be reduced.
Input voltage/current range setting	Specify analog input range to be used. Four input ranges are available for voltage input module while two input ranges are available for current input module.
Output data format setting	Specify digital output type. Four output data formats are provided in this module.
A/D conversion methods	Sampling processing: This is performed if A/D conversion type is not specified. Filter processing: This is to introduce delay when there is a noise or sudden change of input value. Average processing: Average A/D conversion value based on frequency or time output.
Function to detect input disconnected	The user program detects if an analog input with the range of 1 ~ 5V (4 ~ 20mA) is disconnected.

The following are the three A/D conversion functions.

- Sampling processing
- Filter processing
- Average processing

2. Specifications

2.4. Functions

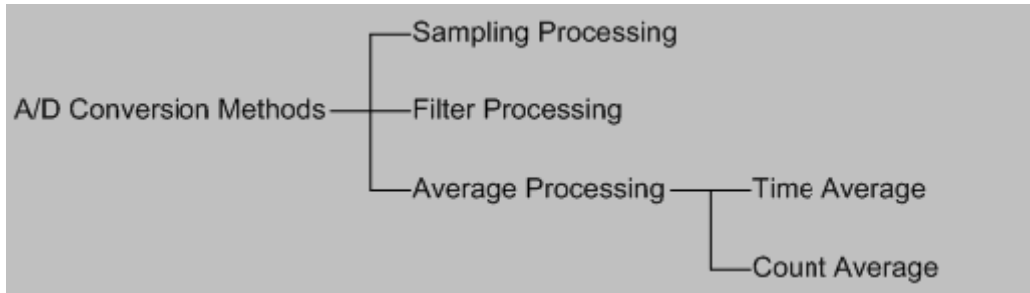

Sampling process

It collects analog input signal through general A/D conversion processing at specific interval of time. The time required for A/D conversion of analog input signal depends on the number of channels used.

(Processing time) = (Number of Channels used) X (Conversion speed)

Example:

If the number of channels used is 3, its process time is = (3) X (250 μ s) = 750 μ s

Sampling is performed to calculate the value of continuous analog signal at a specific interval.

Filter process

Filter process function is used for obtaining stable digital output value by filtering noise or sudden change in input value. Filter constant can be specified for respective channels through user program or I/O parameters setting.

Setting range: 1 ~ 99 (%)

$$F[n] = (1 - \alpha) \times A[n] + \alpha \times F[n - 1]$$

F[n]: Current filter output value

A[n]: Current A/D conversion value

F[n-1]: Previous filter output value

α : Filter constant (0.01 ~ 0.99: previous value added)

1. If the filter setting value is not specified within 1 ~ 99, RUN LED blinks at an interval of 1s. In order to set RUN LED to ON status, set the filter setting value within 1 ~ 99. Then change PLC CPU mode from STOP to RUN. Ensure to clear the request flag (UXY.11.0) from online modification (in RUN mode).

2. If an error occurs in the filter setting value, the default filter setting value 1 is saved.

2MLF-AV8A

- Analog input range: DC -10 ~ 10V, digital output range: 0 ~ 16000.
- If analog input value changes -10V ~ 10V (0 ~ 16000), the filter output value, based on α value, is as specified below.

α value	Filter Output Value			Remarks	
		1 scan	2 scan		3 scan
*1) 0.01	0	15840	15998	15999	1% inclined toward previous value
*2) 0.5	0	8000	12000	14000	50% inclined toward previous value
*3) 0.99	0	160	318	475	99% inclined toward previous value

*1) 16000 output after about 4 scans

*2) 16000 output after about 22 scans

*3) 16000 output after about 1491 scans (372.75ms for 1 channel Run)

2MLF-AC8A

- Analog input current range: DC 0 ~ 20mA, digital output range: 0 ~ 16000.
- If analog input value changes 0mA ~ 10mA (0 ~ 8000), the filter output value, based on α value, is as specified below.

α value	Filter output value			Remarks	
		1 scan	2 scan		3 scan
*1) 0.01	0	7920	7999	7999	1% inclined toward previous value
*2) 0.5	0	4000	6000	7000	50% inclined toward previous value
*3) 0.99	0	80	159	237	99% inclined toward previous value

2. Specifications

2.4. Functions

- *1) 8000 output after about 4 scans
- *2) 8000 output after about 21 scans
- *3) 8000 output after about 1422 scans (355.5ms for 1 channel Run)

If the filter process function is not used, then A/D conversion value is the output. Set the filter value according to the degree of fluctuation of analog input data. If it fluctuates, set a higher filter constant value.

Average process

Average process function is used in A/D conversion to handle abnormal analog input signals. For example, noise, surges, and so on. This process is used to execute A/D conversion of the channel for specified frequency or for specified time, and to save the average of the accumulated sum in the memory. You can define the average processing option and time/frequency value through user program or I/O parameters setting for respective channels.

Average processing type is of time average and count average.

Time average processing

1. Setting range: 4 ~ 16000 (ms)
2. Average processing count within specified time is decided based on the number of channels used.

$$\text{Average processing count} = \frac{\text{Setting Time}}{(\text{Number of Channels Used}) \times (\text{Conversion Speed})}$$

Example 1:

Channels used: 1, setting time: 16000ms

$$\text{Average processing count} = \frac{16000\text{ms}}{1 \times 0.25\text{ms}} = 64000\text{times}$$

Example 2:

Channels used: 8, setting time: 4ms

$$\text{Average processing count} = \frac{4\text{ms}}{8 \times 0.25\text{ms}} = 2\text{times}$$

- a) If the time average value is not specified within 4 ~ 16000, RUN LED blinks at an interval of 1s. In order to set RUN LED to ON status, set the time average value within 4 ~ 16000. Then change PLC CPU mode from STOP to RUN. Ensure to clear the request flag (UXY.11.0) from online modification (in RUN mode).
 - b) If an error occurs in set value of time average, the default value of 2 is saved.
3. Any remainder produced, when set time is divided by (number of channels used X conversion speed), is ignored. Thus, the average processing frequency is the quotient of [(setting time) ÷ (number of channels used x conversion speed)].

Example:

If the number of channels used is 5 and setting time is 151ms

$151\text{ms} \div (5 \times 0.25\text{ms}) = 120\text{times} \dots\dots$ Remainder of 8 is ignored → 120 times

Count average processing

1. Setting range: 2 ~ 64000 (times)
2. The time required for average value (frequency average) to be saved on memory, depends on the number of channels used.

Process time = set frequency X number of channels used X conversion speed

- a) If set value of count average is not specified within 2 ~ 64000, RUN LED blinks at an interval of 1s. In order to set RUN LED to On status, reset the set value of frequency average within 2 ~ 64000. Then change PLC CPU mode from STOP to RUN. Ensure to clear the request flag of error clear (UXY.11.0) from online modification (in RUN mode).
- b) If any error occurs in the set value of frequency average, the default value 2 is saved.

Example:

If the number of channels used is 4, and average processing frequency is 50.

$50 \times 4 \times (0.25\text{ms}) = 50\text{ms}$

2. Specifications

2.4. Functions

Function to detect input signal failure/disconnect

1. Input Range

This detection function is available only if the input signal range is 1 ~ 5V or 4 ~ 20mA. Detection conditions for respective input signal ranges are as described in the below table.

Input signal range	Voltage/Current value regarded as disconnected
1 ~ 5V	0.2V or less
4 ~ 20mA	0.8mA or less

2. Disconnection display for respective channels

Detection status bit of signal failure/disconnect for respective input channels is saved on UXY. 10. (X denotes Base No., and Y denotes Slot No.)

Bit	15	14	13	12	11	10	9	8	7	6	5	4	3	2	1	0
Default	0	0	0	0	0	0	0	0	0	0	0	0	0	0	0	0
Assigned	-	-	-	-	-	-	-	-	CH7	CH6	CH5	CH4	CH3	CH2	CH1	CH0

BIT	Description
0	Normal
1	Disconnected

3. Operation

Each bit is set to 1 if an assigned channel is detected as disconnected, and is set back to 0 when the channel is connected back again. In addition, each bit can be used to detect the disconnection in the user program together with execution conditions.

4. Program example

A program example of analog input module installed on Base No. 0 and Slot No. 2 detecting a input signal failure/disconnect and storing the respective channel number on the P area.

(System configuration)

2. Specifications
2.4. Functions

2MLP- ACF2	2MLI- CPUU			2MLF- AV8A	
---------------	---------------	--	--	---------------	--

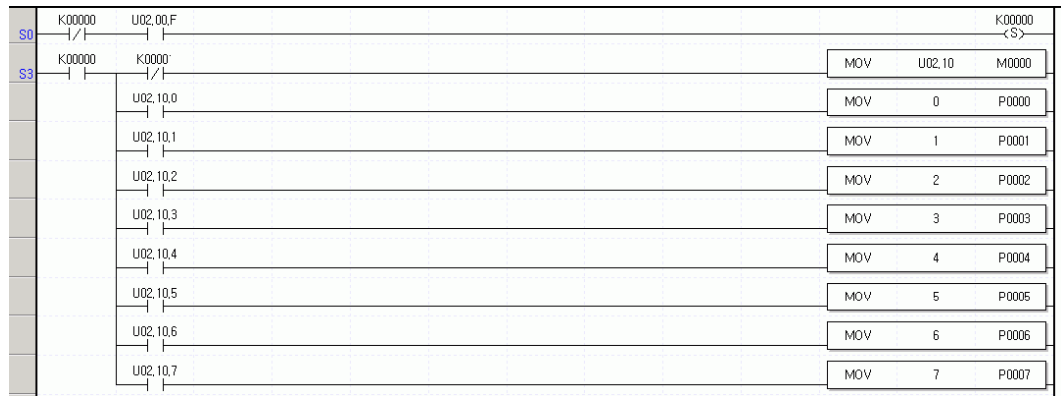

2. Specifications

2.4. Functions

3. Installation and wiring

3.1 Installation

Installation environment

The 2MLF-AV8A/AC8A modules have high reliability regardless of their installation environment. The following factors ensure for system reliability and stability..

1. Environmental prerequisites

Avoid installing the module in places where it is subjected or exposed to:

- a) Water leakage and dust
- b) Continuous shocks or vibrations
- c) Direct sunlight
- d) Dew condensation due to rapid temperature change
- e) Temperatures outside the range of 0 to 55 °C

2. Precautions during installing and wiring

- a) Ensure that no external materials like wire scraps enter the upper part of the PLC during drilling or wiring..
- b) Ensure to install PLC in a location where it is easy for monitoring and use.
- c) Ensure that PLC is not located on the same panel where high voltage equipment is located.
- d) Ensure that the distance from the walls of duct and external equipment is 50mm or more.
- e) Ensure that the PLC is properly grounded to locations that have good ambient noise immunity.

3. Installation and wiring

3.1. Installation

Handling precautions

The following precautions must be taken when unpacking and installing the Analog Input Module.

1. Do not drop the module, and avoid any strong or sudden shocks.
2. Do not remove the PCB from its case. It can result in damage or an abnormal operation.
3. Do not install or remove the module to/from the base when the power supply is turned on.

3.2 Wiring

Precautions for wiring

The following precautions must be taken when wiring the Analog Input Module.

1. The module must be kept away from the alternating current (A/C) wire to avoid surge or inductive noise produced from the A/C supply wire.
2. Select the cable considering the ambient temperature and value of the current. The maximum size of the cable must not be less than the standard cable size of AWG22 (0.3mm²).
3. The cable must not be too close to a hot device/material and in direct contact with oil for a long period, as it can result in damage or abnormal operation due to short-circuit.
4. The polarity check must be performed before wiring.

Wiring examples

The following figures illustrate a sample wiring of 2MLF-AV8A/AC8A.

2MLF-AV8A

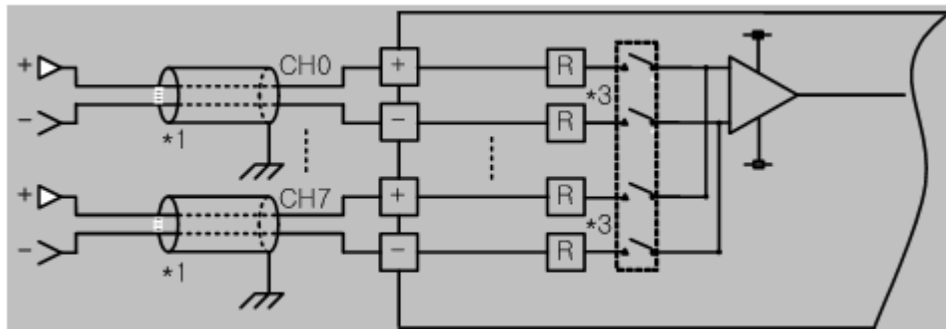

3. Installation and wiring
3.2. Wiring

2MLF-AC8A

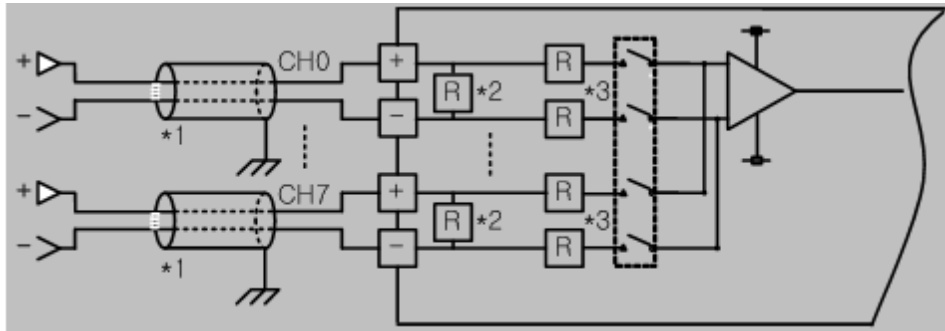

1. Use a 2-core twisted shielded wire. AWG 22 is recommended for the cable standard.
 - a) 2MLF-AC8A's input resistance is 250Ω (typical).
 - b) 2MLF-AV8A's input resistance is 1MΩ (minimum).
2. Enable (Run) only the channels those are used and disable the rest to maintain best overall conversion speed.
3. Analog input module does not provide power for the input device. Use an external power supply.

Wiring example of 2-wire sensor/transmitter (current input)

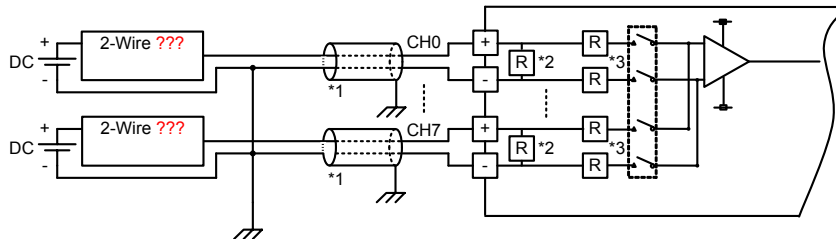

Wiring example of 4- wire sensor/transmitter (voltage/current input)

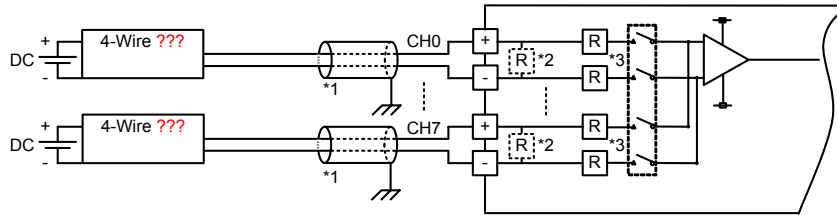

Relationship between voltage input accuracy and wiring length

With voltage input, the wiring (cable) length between transmitter/sensor and module has an effect on digitally-converted values of the module as specified below:

where,

Rc: Resistance value due to line resistance of cable

Rs: Internal resistance value of transmitter or sensor

Ri: Internal resistance value (1MΩ) of voltage input module

Vin: Voltage allowed to analog input module

% Vi: Tolerance of converted value (%) due to source and cable length in voltage input

$$V_{in} = \frac{R_i \times V_s}{[R_s + (2 \times R_c) + R_i]}$$

$$\%Vi = \left(1 - \frac{V_{in}}{V_s}\right) \times 100 \%$$



ATTENTION

With current input, there is no accuracy, tolerance caused by cable length and internal resistance of the source.

3. Installation and wiring
3.2. Wiring

4. Operating Procedures and Monitoring

4.1 Operating procedures

The following flowchart illustrates the procedure to initialize the operation of the Analog Input Module.

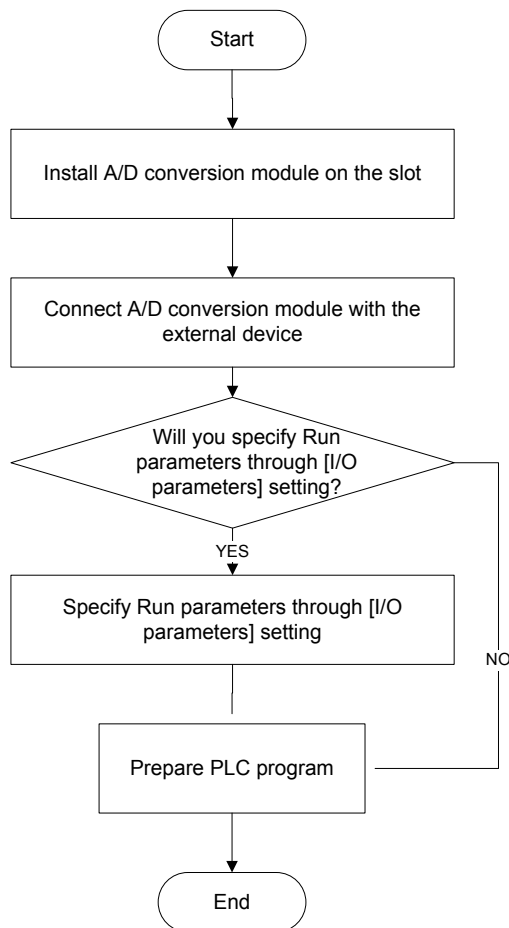

Figure 9 – Operating procedure

4. Operating Procedures and Monitoring

4.2. Run parameters setting

4.2 Run parameters setting

The Run parameters of A/D conversion module can be specified using SoftMaster's I/O parameters.

Setting items

SoftMaster provides a graphical user interface (GUI) for setting the parameters of A/D conversion module. These settings are available as I/O parameters option on the SoftMaster project window.

The following table lists the I/O parameter setting functions..

Table 4 – I/O parameter setting functions

Item	Details
I/O parameters	<p>Specify the following setting items necessary for the module operation.</p> <ul style="list-style-type: none">• Channel Enable/Disable• Input Voltage/Current Range• Output Data Format Setting• Filter Processing Enable/Disable Setting• Filter Constant Setting• Average Processing Enable/Disable Setting• Average Processing Method Setting• Average Value Setting <p>The above data specified by user through SoftMaster is directly saved on A/D conversion module when Special Module Parameters are downloaded. In other words, the download has no relevance to the CPU status, that is, RUN or STOP.</p>

Setting I/O parameters

The procedure for setting I/O parameters based on 2MLF-AV8A is described as follows:

The procedure remains same for 2MLF-AC8A.

Step	Action
1	Run SoftMaster to create a project. (Refer to <i>SoftMaster User's Guide</i> for details on how to create the project)
2	On the Project window, double-click I/O Parameters .

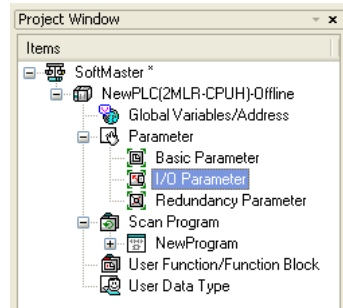

The **I/O Parameter Setting** window appears.

4. Operating Procedures and Monitoring
4.2. Run parameters setting

- | Step | Action |
|------|---|
| 3 | Click the slot on which the A/D conversion module is installed. Here, the 8-channel voltage type of A/D conversion module is installed on Base No. 1, Slot No. 4. |
| 4 | Click the arrow button on the Module cell display the list of applicable modules. Select the appropriate module. |

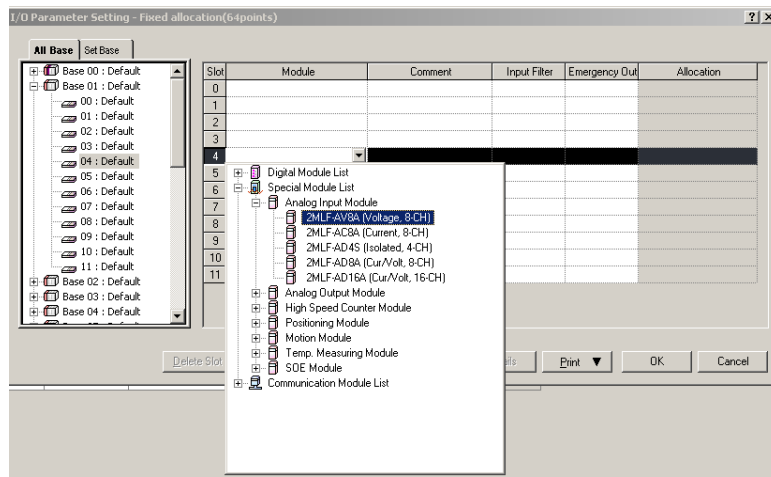

- 5 Click **Details** and specify the parameters for respective channel as below:

Channel Status: This enables or disables the respective channel. Select either Disable or Enable from the drop-down list.

Parameter	CH 0	CH 1	CH 2	CH 3	CH 4	CH 5	CH 6	CH 7
<input type="checkbox"/> Channel status	Disable	Disable	Disable	Disable	Disable	Disable	Disable	Disable
<input type="checkbox"/> Input range	Disable	1~5V	1~5V	1~5V	1~5V	1~5V	1~5V	1~5V
<input type="checkbox"/> Output type	Enable	0~16000	0~16000	0~16000	0~16000	0~16000	0~16000	0~16000
<input type="checkbox"/> Filter process	Disable	Disable	Disable	Disable	Disable	Disable	Disable	Disable
Filter constant	1	1	1	1	1	1	1	1
<input type="checkbox"/> Average setting	Disable	Disable	Disable	Disable	Disable	Disable	Disable	Disable
<input type="checkbox"/> Average processing	Count-Avr	Count-Avr	Count-Avr	Count-Avr	Count-Avr	Count-Avr	Count-Avr	Count-Avr
Average value	2	2	2	2	2	2	2	2

Input range: Select the range for analog input voltage (or current) as applicable. 2MLF-AV8A provides four voltage input ranges, and 2MLFAC8A provides two current input ranges.

4. Operating Procedures and Monitoring
4.2. Run parameters setting

Step

Action

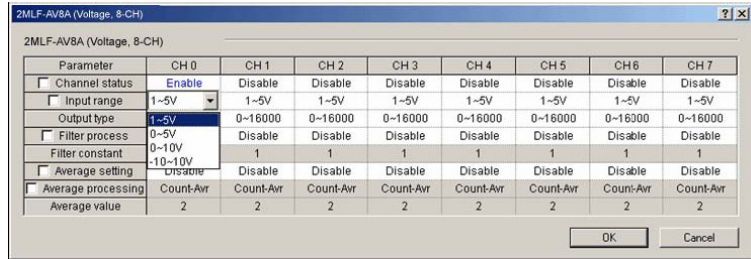

4. Operating Procedures and Monitoring
4.2. Run parameters setting

Step **Action**

Output type: Select the format of output data from the list of available formats.

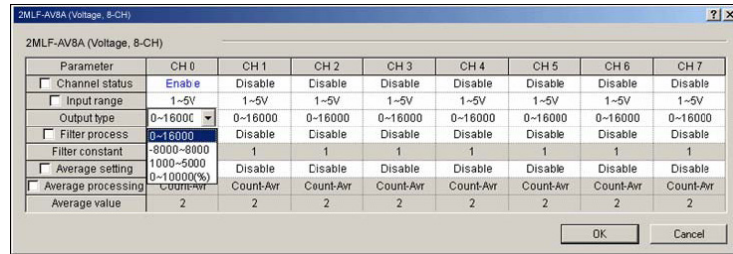

Filter process: Enable or disable the filter process as necessary.

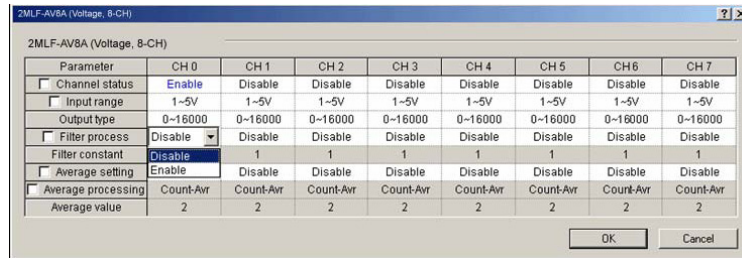

Filter constant: This field is active only when the filter process is enabled. Double-click the filter constant to enter the value. The available range is 1~99.

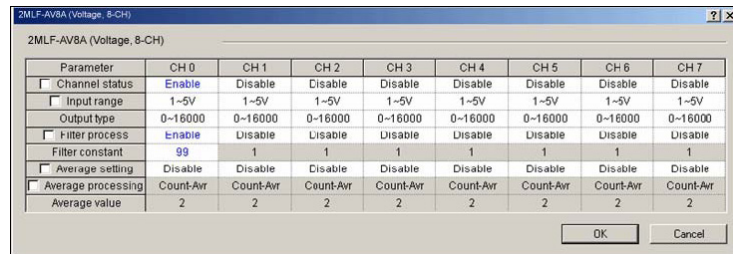

Average setting: Enable or disable the average process as necessary.

4. Operating Procedures and Monitoring

4.2. Run parameters setting

Step

Action

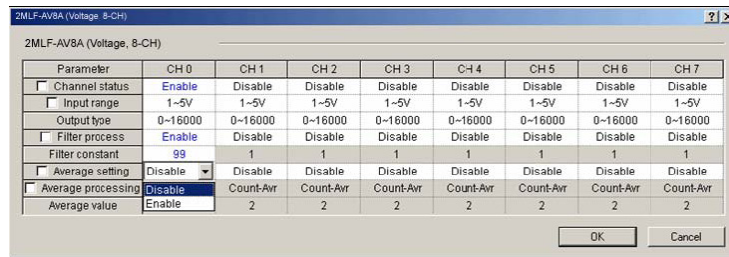

Average processing: This field is active only when the average process is enabled. You can select average processing as time average or count average.

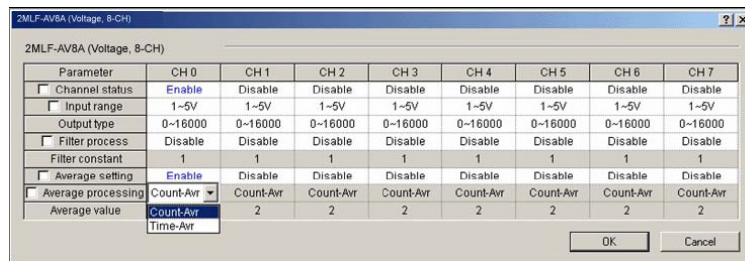

Average value: This field is active only when the average process setting is enabled. Double-click the average value to input the value. The available range is 2 ~ 64000 for count average, and 4 ~ 16000 for time average.

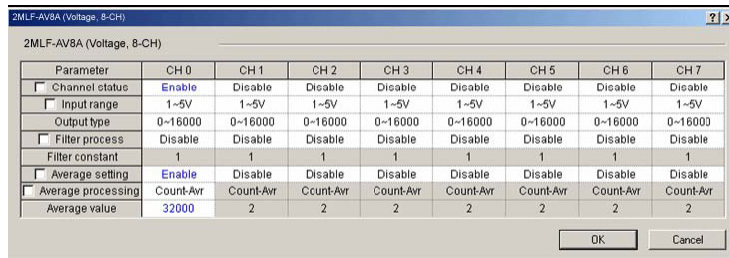

Select all channels to change parameters.

- Select the check box in the parameters item in order to change the parameters of all channels to identical setting value.
- Change the parameters of any one channel to change the parameters of the all channels at a time.

4. Operating Procedures and Monitoring
4.2. Run parameters setting

Step **Action**

Following figure shows an example where the Channel Status of all the channels are enabled at the same time.

Parameter	CH 0	CH 1	CH 2	CH 3	CH 4	CH 5	CH 6	CH 7
<input checked="" type="checkbox"/> Channel status	Enable	Enable	Enable	Enable	Enable	Enable	Enable	Enable
<input type="checkbox"/> Input range	1~5V	1~5V	1~5V	1~5V	1~5V	1~5V	1~5V	1~5V
Output type	0~16000	0~16000	0~16000	0~16000	0~16000	0~16000	0~16000	0~16000
<input type="checkbox"/> Filter process	Disable	Disable	Disable	Disable	Disable	Disable	Disable	Disable
Filter constant	1	1	1	1	1	1	1	1
<input type="checkbox"/> Average setting	Enable	Disable	Disable	Disable	Disable	Disable	Disable	Disable
<input type="checkbox"/> Average processing	Count-Avr	Count-Avr	Count-Avr	Count-Avr	Count-Avr	Count-Avr	Count-Avr	Count-Avr
Average value	32000	2	2	2	2	2	2	2

4.3 Special module monitoring

The special module monitoring function helps you to monitor the analog input modules for testing. It also helps in tuning parameters like average processing constants.

To monitor and test the module, perform the following steps.

Step	Action
1	Click Online > Connect . The SoftMaster is connected to PLC.
2	Click Monitor > Special Module Monitoring . The Special Module List window appears. This window displays base/slot information in addition to special module type.



ATTENTION

If the module status is not Online, the **Special Module Monitoring** menu is disabled.

- 3 Click **Module Info** to display the module information as shown in the following figure.

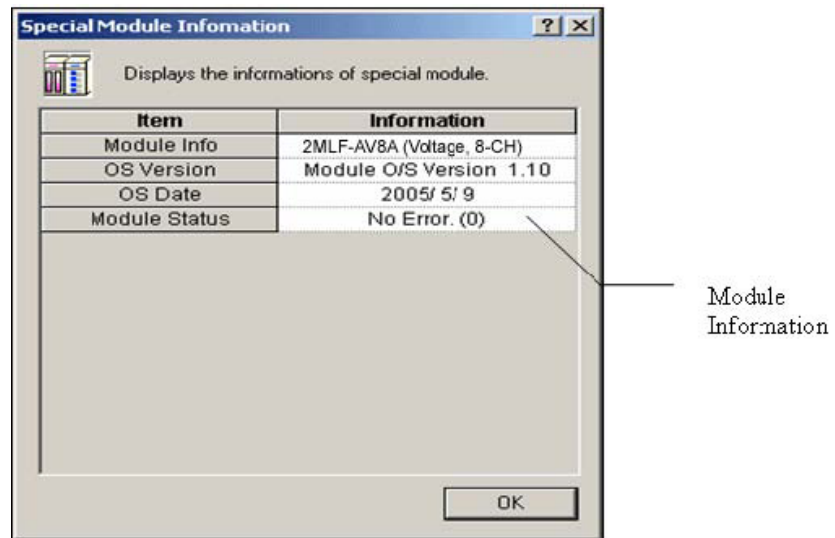

- 4 On the **Special Module List** window, select the module and click **Monitor**. The **Monitor Special Module** window appears.

4. Operating Procedures and Monitoring
4.3. Special module monitoring

Step **Action**

Item	Max/Min Value	Current Value
CH0 A/D Value		
CH1 A/D Value		
CH2 A/D Value		
CH3 A/D Value		
CH4 A/D Value		
CH5 A/D Value		
CH6 A/D Value		
CH7 A/D Value		

Item	Setting Value	Current Value
Channels		
Channel Status	Disable	CH 0
Input Range	1~5V	
Output Type	0~16000	
Filter Process	Disable	
Filter Constants	1	
Average Process	Disable	
Average Method	Count-Avr	
Average Value	2	

Selected channel

Parameter items of selected channel

The four buttons available are:

- Reset max./min value
- Start Monitoring
- Test
- Close

The current value of A/D conversion output and maximum/minimum value are displayed in upper-half of the monitoring window. Parameter settings for each selected channel are displayed in the lower-half of the monitoring window.

- 5** Click **Start Monitoring** to display the current values A/D conversion output of all channels.

Step	Action

- 6 Click **Test** to temporarily modify the current parameters of A/D conversion module for testing. Make suitable parameter changes in the lower-half of the window and click **Test** button to execute the changes.

To permanently download new settings to the A/D conversion module, make changes in the **I/O parameters setting** window.

- 7 **Reset Max./Min. value** The maximum/minimum value field in the window shows the maximum and minimum value of A/D conversion computed for the current session. Click **Reset max./min. value** to initialize them. The following figure shows the channel 0's A/D converted value when reset.

4. Operating Procedures and Monitoring
4.3. Special module monitoring

Step **Action**

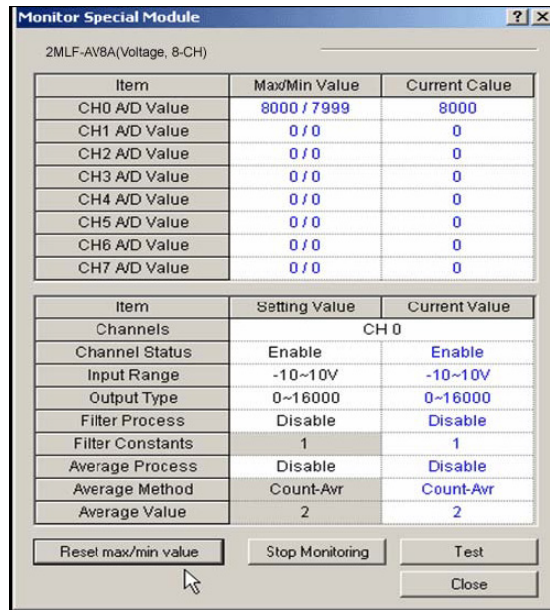

8 Click **Close** to close the monitoring/test window.

4.4 Register special module variables

This section describes the automatic registration function of Special Module Variables in the SoftMaster. In MasterLogic PLCs, examples of Special Modules are Analog I/O Modules, RTD, TC modules, HSC modules, position control modules.

Registering special module variables

Register the variables for each module referring to the special module information set in the I/O parameters. You can modify the variables.

To modify the variables, perform the following steps.

Step	Action
1	On the Project Window, double-click I/O parameters . The I/O Parameters Setting window appears.
2	Click the module area of the concerned slot to select the applicable module and select the special module type..
3	Double-click the selected 2MLF-AV8A module or click Details to set parameter.
4	On the Project Window , double-click Global Variables/Address . The registered global variables are displayed in the right-pane.
5	To register special module variables automatically in the global variables list, click Edit > Register Special/Communication Module Variables .

The following confirmation message appears.

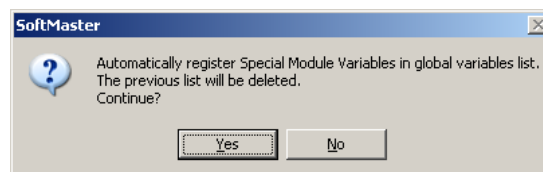

4. Operating Procedures and Monitoring

4.4. Register special module variables

Step	Action
------	--------

- | | |
|---|---|
| 6 | Click Yes . The registered variables are displayed as shown in the following figure. |
|---|---|

Variable Kind	Variable Name	Type	Address	Initial Value	Retain	Used	Comment
VAR_GLOBAL	_0202_CH0_ACT	BOOL	%UX2.2.16		<input type="checkbox"/>	<input type="checkbox"/>	Analog Input Module: CH0 Active
VAR_GLOBAL	_0202_CH0_DATA	INT	%UW2.2.2		<input type="checkbox"/>	<input type="checkbox"/>	Analog Input Module: CH0 Output
VAR_GLOBAL	_0202_CH0_HOOR	BOOL	%UX2.2.320		<input type="checkbox"/>	<input type="checkbox"/>	Analog Input Module: CH0 High Out Of Range
VAR_GLOBAL	_0202_CH0_IDD	BOOL	%UX2.2.160		<input type="checkbox"/>	<input type="checkbox"/>	Analog Input Module: CH0 Input Disconnection
VAR_GLOBAL	_0202_CH0_LOOR	BOOL	%UX2.2.336		<input type="checkbox"/>	<input type="checkbox"/>	Analog Input Module: CH0 Low Out Of Range
VAR_GLOBAL	_0202_CH1_ACT	BOOL	%UX2.2.17		<input type="checkbox"/>	<input type="checkbox"/>	Analog Input Module: CH1 Active
VAR_GLOBAL	_0202_CH1_DATA	INT	%UW2.2.3		<input type="checkbox"/>	<input type="checkbox"/>	Analog Input Module: CH1 Output
VAR_GLOBAL	_0202_CH1_HOOR	BOOL	%UX2.2.321		<input type="checkbox"/>	<input type="checkbox"/>	Analog Input Module: CH1 High Out Of Range
VAR_GLOBAL	_0202_CH1_IDD	BOOL	%UX2.2.161		<input type="checkbox"/>	<input type="checkbox"/>	Analog Input Module: CH1 Input Disconnection
VAR_GLOBAL	_0202_CH1_LOOR	BOOL	%UX2.2.337		<input type="checkbox"/>	<input type="checkbox"/>	Analog Input Module: CH1 Low Out Of Range
VAR_GLOBAL	_0202_CH2_ACT	BOOL	%UX2.2.18		<input type="checkbox"/>	<input type="checkbox"/>	Analog Input Module: CH2 Active
VAR_GLOBAL	_0202_CH2_DATA	INT	%UW2.2.4		<input type="checkbox"/>	<input type="checkbox"/>	Analog Input Module: CH2 Output
VAR_GLOBAL	_0202_CH2_HOOR	BOOL	%UX2.2.322		<input type="checkbox"/>	<input type="checkbox"/>	Analog Input Module: CH2 High Out Of Range
VAR_GLOBAL	_0202_CH2_IDD	BOOL	%UX2.2.162		<input type="checkbox"/>	<input type="checkbox"/>	Analog Input Module: CH2 Input Disconnection
VAR_GLOBAL	_0202_CH2_LOOR	BOOL	%UX2.2.338		<input type="checkbox"/>	<input type="checkbox"/>	Analog Input Module: CH2 Low Out Of Range
VAR_GLOBAL	_0202_CH3_ACT	BOOL	%UX2.2.19		<input type="checkbox"/>	<input type="checkbox"/>	Analog Input Module: CH3 Active
VAR_GLOBAL	_0202_CH3_DATA	INT	%UW2.2.5		<input type="checkbox"/>	<input type="checkbox"/>	Analog Input Module: CH3 Output

Saving variables

The variables can be saved as a text file as follows:

- On the **Global Variable/Address** window, click **Edit > Export Variables to File**.

Program example with variable and address

The below program shows procedure to read the A/D conversion values when the module is in READY condition and to transfer each of the 8 channels digital value (only when enabled) to D area.

4. Operating Procedures and Monitoring
 4.4. Register special module variables

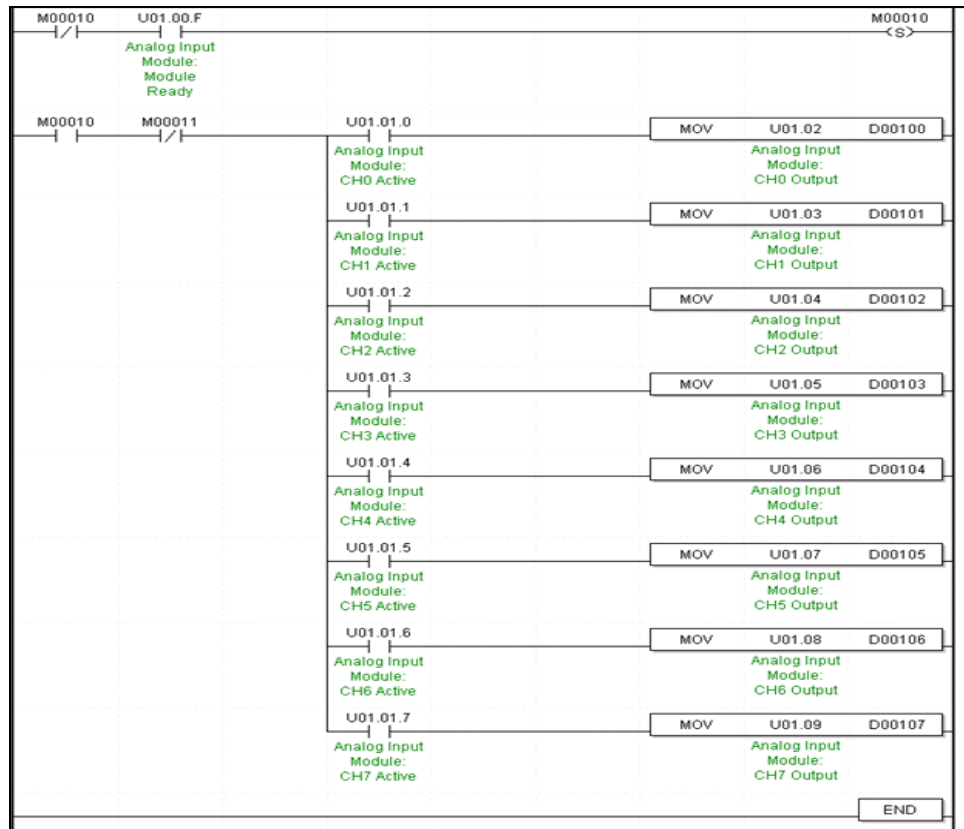

Figure 10 –Program example with variables and addresses

4. Operating Procedures and Monitoring

4.4. Register special module variables

5. Configuration and Function of Internal Memory

5.1 Internal memory configuration

A/D conversion module has its own internal memory to transmit/receive data to/from PLC CPU.

The following table lists the details of the I/O area of A/D converted data..

Table 5 – I/O area of A/D converted data

Address Assigned	Global Variable	Details	R/W	Direction
%UXa.b.0	_ab_ERR	Module ERROR	R	A/D → CPU
%UXa.b.15	_ab_RDY	Module READY		
%UXa.b.16	_ab_CH0_ACT	CH0 Active	R	A/D → CPU
%UXa.b.17	_ab_CH1_ACT	CH1 Active		
%UXa.b.18	_ab_CH2_ACT	CH2 Active		
%UXa.b.19	_ab_CH3_ACT	CH3 Active		
%UXa.b.20	_ab_CH4_ACT	CH4 Active		
%UXa.b.21	_ab_CH5_ACT	CH5 Active		
%UXa.b.22	_ab_CH6_ACT	CH6 Active		
%UXa.b.23	_ab_CH7_ACT	CH7 Active		
%UWa.b.2	_ab_CH0_DATA	CH0 Output	R	A/D → CPU
%UWa.b.3	_ab_CH1_DATA	CH1 Output		
%UWa.b.4	_ab_CH2_DATA	CH2 Output		
%UWa.b.5	_ab_CH3_DATA	CH3 Output		
%UWa.b.6	_ab_CH4_DATA	CH4 Output		
%UWa.b.7	_ab_CH5_DATA	CH5 Output		
%UWa.b.8	_ab_CH6_DATA	CH6 Output		
%UWa.b.9	_ab_CH7_DATA	CH7 Output		

5. Configuration and Function of Internal Memory

5.1. Internal memory configuration

Address Assigned	Global Variable	Details	R/W	Direction
%UXa.b.160	_ab_CH0_IDD	CH0 Input Disconnection	R	A/D → CPU
%UXa.b.161	_ab_CH1_IDD	CH1 Input Disconnection		
%UXa.b.162	_ab_CH2_IDD	CH2 Input Disconnection		
%UXa.b.163	_ab_CH3_IDD	CH3 Input Disconnection		
%UXa.b.164	_ab_CH4_IDD	CH4 Input Disconnection		
%UXa.b.165	_ab_CH5_IDD	CH5 Input Disconnection		
%UXa.b.166	_ab_CH6_IDD	CH6 Input Disconnection		
%UXa.b.167	_ab_CH7_IDD	CH7 Input Disconnection		
%UXa.b.176	_ab_ERR_CLR	Error clear request	W	CPU → A/D

In the address assigned, 'a' denotes the Base No. and 'b' denotes the Slot No. on which the module is installed.

In order to read 'CH1 digital value' of A/D conversion module installed on Base No. 0, Slot No. 4, it is displayed as %UW0.4.3.

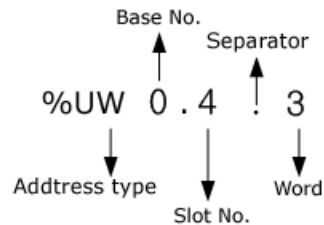

In order to read 'CH4 Input disconnection' of A/D conversion module installed on Base No. 0, Slot No. 5, it is displayed as %UX0.5.164.

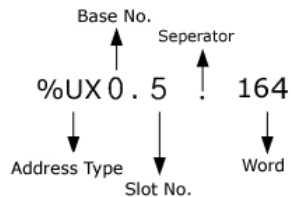

5. Configuration and Function of Internal Memory
5.1. Internal memory configuration

Setting area of Run parameters

The following table lists the details of the setting area of A/D conversion module's Run parameters.

Table 6 – Setting area of run parameters

Memory Address		Details	R/W	Remarks
Hex	Dec			
0 _H	0	Channel enable/disable setting	R/W	PUT
1 _H	1	Setting range of input voltage/current	R/W	PUT
2 _H	2	Output data format setting	R/W	PUT
3 _H	3	Filter processing enable/disable setting	R/W	PUT
4 _H	4	CH0 filter constant	R/W	PUT
5 _H	5	CH1 filter constant		
6 _H	6	CH2 filter constant		
7 _H	7	CH3 filter constant		
8 _H	8	CH4 filter constant		
9 _H	9	CH5 filter constant		
A _H	10	CH6 filter constant		
B _H	11	CH7 filter constant		
C _H	12	Average processing enable/disable setting	R/W	PUT
D _H	13	Average processing method setting	R/W	
E _H	14	CH0 average value	R/W	
F _H	15	CH1 average value		
10 _H	16	CH2 average value		
11 _H	17	CH3 average value		
12 _H	18	CH4 average value		

5. Configuration and Function of Internal Memory

5.1. Internal memory configuration

Memory Address		Details	R/W	Remarks
Hex	Dec			
13 _H	19	CH5 average value		
14 _H	20	CH6 average value		
15 _H	21	CH7 average value		
16 _H	22	Error code	R/W	GET

Note: R/W indicates Read/Write if available from PLC program.

5.2 I/O area of A/D converted data

Module Ready/Error (%UXa.b.0, %UXa.b.15; a: Base No., b: Slot No.)

%UXa.b.15: It is ON when PLC CPU is powered or reset with A/D conversion, ready to process A/D conversion.

%UXa.b.0: It is a flag to display the error status of A/D conversion module.

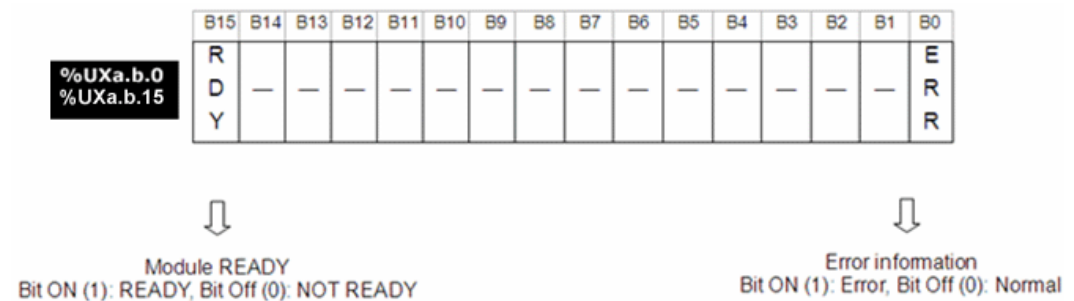

Run channel (%UXa.b.16~23, a: Base No., b: Slot No.)

This area stores Enable/Disable (Run/Stop) information of individual channel.

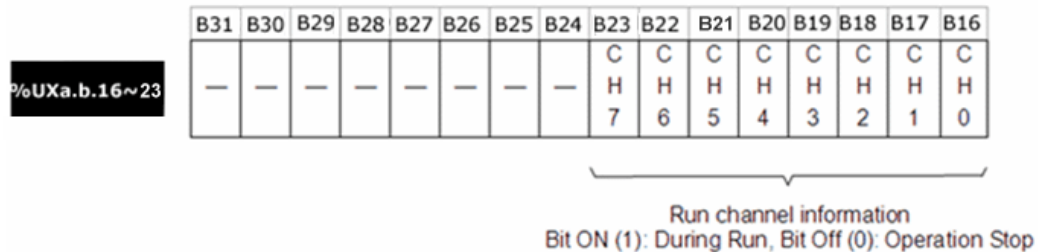

Digital output value (%UWa.b.2 ~9, a: Base No., b: Slot No.)

A/D conversion value is output to buffer memory addresses 2 ~ 9 (%UWa.b.2 ~9) for respective channels.

Digital output value is saved in 16-bit binary.

5. Configuration and Function of Internal Memory

5.2. I/O area of A/D converted data

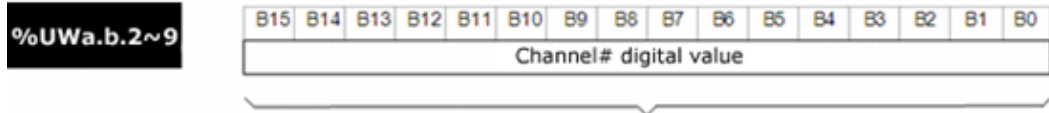

Address	Details
%UWa.b.2	CH0 digital value
%UWa.b.3	CH1 digital value
%UWa.b.4	CH2 digital value
%UWa.b.5	CH3 digital value
%UWa.b.6	CH4 digital value
%UWa.b.7	CH5 digital value
%UWa.b.8	CH6 digital value
%UWa.b.9	CH7 digital value

Detect input signal failure/disconnect flag (%UXa.b.160~167 a: Base No., b: Slot No.)

Failure/disconnect status bit for respective input channels is saved in %UXa.b.

Each bit is set to 1 if an assigned channel is detected as disconnected, and it is reset to 0 if connected back. In addition, this bit can be used in the program, together with execution conditions.

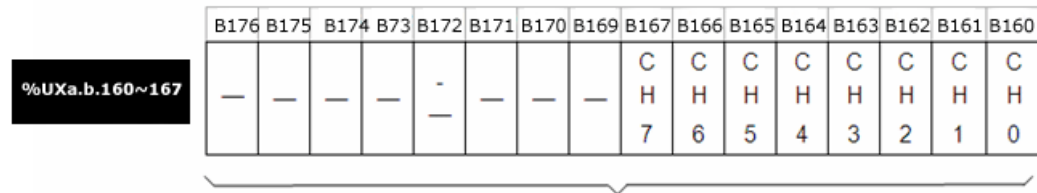

BIT	Description
0	Normal
1	Disconnection

Error clear request flag (%UXa.b.176, a: Base No., b: Slot No.)

Whenever a parameter setting error occurs in the A/D module (for example, incorrect filter constant), the RUN LED starts blinking and the error code would be set in address No. 22. This error code/status is not automatically cleared, even if parameter setting errors are rectified. The error status/code is cleared when the CPU provides an ‘error clear request’ (%UXa.b.176 bit ON) to the module. Once the error status is cleared, RUN LED returns to steady On status.

The flag ‘error clear request’ should always be used together with %UXa.b for correct operation as in the below example.

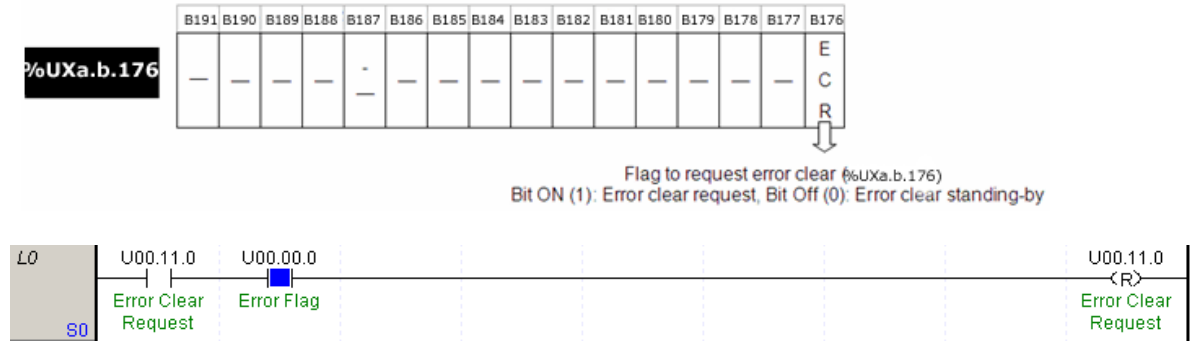

5. Configuration and Function of Internal Memory

5.3. Operation parameters settings area

5.3 Operation parameters settings area

One word (2 bytes) is assigned for each address in the internal memory, which can be displayed in 16 bits. Each of the 16 bits can be set: On – ‘1’ or Off – ‘0’ for various functions.

Address 0 - A/D conversion enable/disable status for each channel

Enable/disable status of A/D conversion for each channel can be set as below:

1. Set all unused channels as ‘Disable’. This saves the conversion cycle time.

	B15	B14	B13	B12	B11	B10	B9	B8	B7	B6	B5	B4	B3	B2	B1	B0
Address “0”	—	—	—	—	—	—	—	—	C	C	C	C	C	C	C	C
									H	H	H	H	H	H	H	H
									7	6	5	4	3	2	1	0

BIT	Description
0	Disable
1	Enable

2. B8 ~ B15 bits are reserved for future use.

Address 1 - Input voltage/current range

1. The range of analog input voltage/current is specified for each channel.
2. If the analog input range is not specified, the range of all the channels is set to 1 ~ 5V (or 4 ~ 20mA).
3. Setting range of analog input voltage/current is as explained below.

5. Configuration and Function of Internal Memory
5.3. Operation parameters settings area

2MLF-AV8A

Address "1"

B15	B14	B13	B12	B11	B10	B9	B8	B7	B6	B5	B4	B3	B2	B1	B0
C		C		C		C		C		C		C		C	
H		H		H		H		H		H		H		H	
7		6		5		4		3		2		1		0	

BIT	Description
00	1 V ~ 5 V
01	0 V ~ 5 V
10	0 V ~ 10 V
11	-10 V ~ 10 V

5. Configuration and Function of Internal Memory

5.3. Operation parameters settings area

2MLF-AC8A

Address "1"	B15	B14	B13	B12	B11	B10	B9	B8	B7	B6	B5	B4	B3	B2	B1	B0
	C		C		C		C		C		C		C		C	
	H		H		H		H		H		H		H		H	
	7		6		5		4		3		2		1		0	

BIT	Description
00	4 mA ~ 20 mA
01	0 mA ~ 20 mA

5. Configuration and Function of Internal Memory
5.3. Operation parameters settings area

Address 2 - Output data format

The range of digital output data for analog input is specified for each channel.

1. If the output data range is not specified, the range of all the channels is set to 0 ~ 16000.
2. Setting range of digital output data range is as explained below.

Address "2"	B15	B14	B13	B12	B11	B10	B9	B8	B7	B6	B5	B4	B3	B2	B1	B0
	C	C	C	C	C	C	C	C	C	C	C	C	C	C	C	C
	H	H	H	H	H	H	H	H	H	H	H	H	H	H	H	H
	7	6	5	4	3	2	1	0								

BIT	Description
00	0 ~ 16000
01	-8000 ~ 8000
10	Precise Value
11	0 ~ 10000

Precise value has the following digital output ranges for the analog input range.

2MLF-AV8A

Analog input	-10 ~ 10V	0 ~ 10V	0 ~ 5V	1 ~ 5V
Digital output				
Precise Value	-10000 ~ 10000	0 ~ 10000	0 ~ 5000	1000 ~ 5000

2MLF-AC8A

Analog input	4 ~ 20mA	0 ~ 20mA
Digital output		
Precise Value	4000 ~ 20000	0 ~ 20000

5. Configuration and Function of Internal Memory

5.3. Operation parameters settings area

Address 3 - Filter process Enable/Disable

The Enable/Disable status of filter process is specified for each channel.

1. If the filter process is not specified, all the channels are sampled.
2. Setting of the filter process is as explained below.

Address "3"	B15	B14	B13	B12	B11	B10	B9	B8	B7	B6	B5	B4	B3	B2	B1	B0
	—	—	—	—	—	—	—	—	C	C	C	C	C	C	C	C
									H	H	H	H	H	H	H	H
									7	6	5	4	3	2	1	0

BIT	Description
0	Disable
1	Enable

Address 4-11 - Filter constant

Default value of the filter constant is 1. Setting range for the filter constant is 1 ~ 99.

If any other value exceeding the setting range is specified, error code 50# is displayed on error code address 22.

If the filter constant is not specified, the filter constant is set to '1'.

Setting of the filter constant is as explained below.

5. Configuration and Function of Internal Memory
5.3. Operation parameters settings area

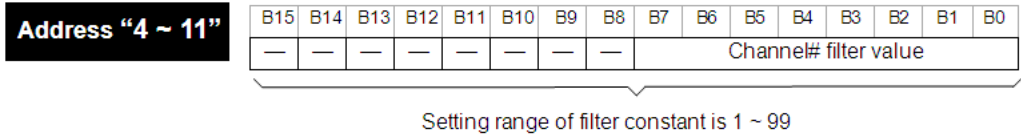

Address	Details
Address No. 4	CH0 filter value
Address No. 5	CH1 filter value
Address No. 6	CH2 filter value
Address No. 7	CH3 filter value
Address No. 8	CH4 filter value
Address No. 9	CH5 filter value
Address No. 10	CH6 filter value
Address No. 11	CH7 filter value



ATTENTION

These filter constants are effective only when the filter process is set to 'Enable'.

Address 12 - Average process Enable/Disable

The Enable/Disable status of average process is specified for each channel.

If the average process is not specified, all the channels are sampled.

Setting of the average process is as explained below.

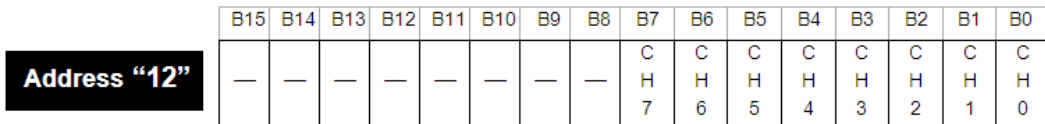

BIT	Description
0	Disable
1	Enable

5. Configuration and Function of Internal Memory

5.3. Operation parameters settings area

Address 13 - Average process method (address number 13)

This area is used for specifying average processing method. The available options are count average and time average. If neither is specified, all the channels are set to count average process by default.

Address "13"	B15	B14	B13	B12	B11	B10	B9	B8	B7	B6	B5	B4	B3	B2	B1	B0
	—	—	—	—	—	—	—	—	C	C	C	C	C	C	C	C
									H	H	H	H	H	H	H	H
									7	6	5	4	3	2	1	0

BIT	Description
0	Count average
1	Time average



ATTENTION

This setting is effective only when the average process is set to 'Enable'.

Address 14-21 - Average value

Setting range of time/count average's constant value is explained as follows:

- Setting range of time average: 4 ~ 16000 (ms)
- Setting range of count average: 2 ~ 64000 (times)

If it exceeds the range:

1. Error No. 60X is generated if time average range is exceeded.
2. Error No. 70X is generated if count average range is exceeded.

The above error codes are available on address 22. If the above error occurs, the default values are applied for average processing.

Default values are time average: 4, Frequency average: 2

The process value of time/count average is as stored below:

5. Configuration and Function of Internal Memory

5.3. Operation parameters settings area

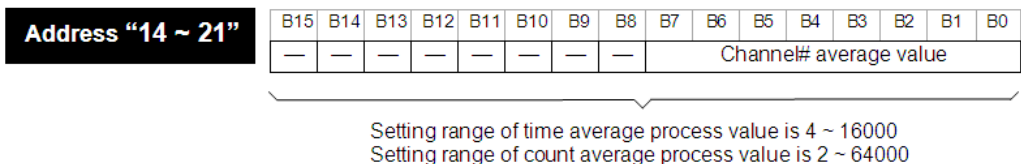

Address	Details
14	CH0 average value
15	CH1 average value
16	CH2 average value
17	CH3 average value
18	CH4 average value
19	CH5 average value
20	CH6 average value
21	CH7 average value



ATTENTION

This setting is effective only when the average process method (time or count) is set to 'Enable'.

Error code (address number 22)

When the A/D conversion module detects any error, during operation, it generates an error code and saves it in Address 22.

5. Configuration and Function of Internal Memory

5.3. Operation parameters settings area

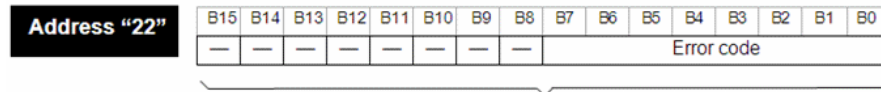

Refer to the table below for detailed error codes.

Error Code (Dec)	Error Details	Remarks
0	Normal Run	RUN LED On
20	Module error (A/D Conversion Error)	RUN LED flickers every 0.2 sec.
40#	Offset value with the range of 1 ~ 5 V (4 ~ 20 mA) is set greater than or equal to Gain value.	RUN LED flickers every 1 sec.
41#	Offset value with the range of 0 ~ 5 V (0 ~ 20 mA) is set greater than or equal to Gain value.	
42#	Offset value with the range of 0 ~ 10 V is set greater than or equal to Gain value.	
43#	Offset value with the range of -10 ~ 10 V is set greater than or equal to Gain value.	
50#	Filter constant setting range exceeded	
60#	Time average setting range exceeded	
70#	Count average setting range exceeded	
80#	Analog input range setting error	Applied to 2MLF-AC8A



ATTENTION

1. # denotes the channel with error found.
2. For more details of error codes, refer to section Troubleshooting.
3. If more than two errors occur, the module saves only the first error code.
4. Once the cause of error condition is rectified, use the flag 'error clear request' to clear the error code and this changes the RUN LED return to steady ON. For more information, refer to section Error Clear request flag (UXY.11.0, X: Base No., Y: Slot No.).

5.4 Global variable (data area)

How to use global variable

There are two ways to register a global variable.

- Automatic registration after I/O parameter setting at project window
- Batch registration after I/O parameter setting

For automatic registration and batch registration, refer to section Registering special module variables.

Local variable registration

You can register the variables as local variables among registered global variables.

To register local variables in I/O parameter, perform the following steps.

Step	Action
1	In the Project Window , double-click Local Variables under Scan Program .
2	Right-click in the local variable window and click Add EXTERNAL variable .

5. Configuration and Function of Internal Memory
5.4. Global variable (data area)

Step	Action

How to use local variables

This section describes the how to add a global variable at local program.

The following is an example for getting the conversion value of CH0 of A/D conversion module to %MW0.

1. By using the following MOVE function, double-click variable part ahead of IN, then **Select Variable** window displays.

5. Configuration and Function of Internal Memory

5.4. Global variable (data area)

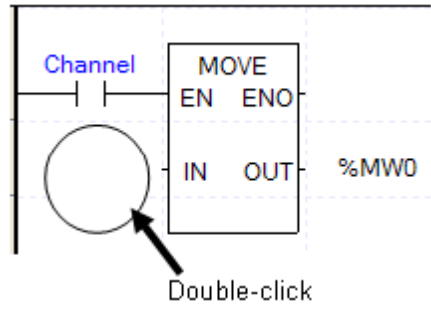

2. On **Select Variable** window, select global variable under **Variable List** and select relevant base (8 base, 4 slot) at global variable view item.

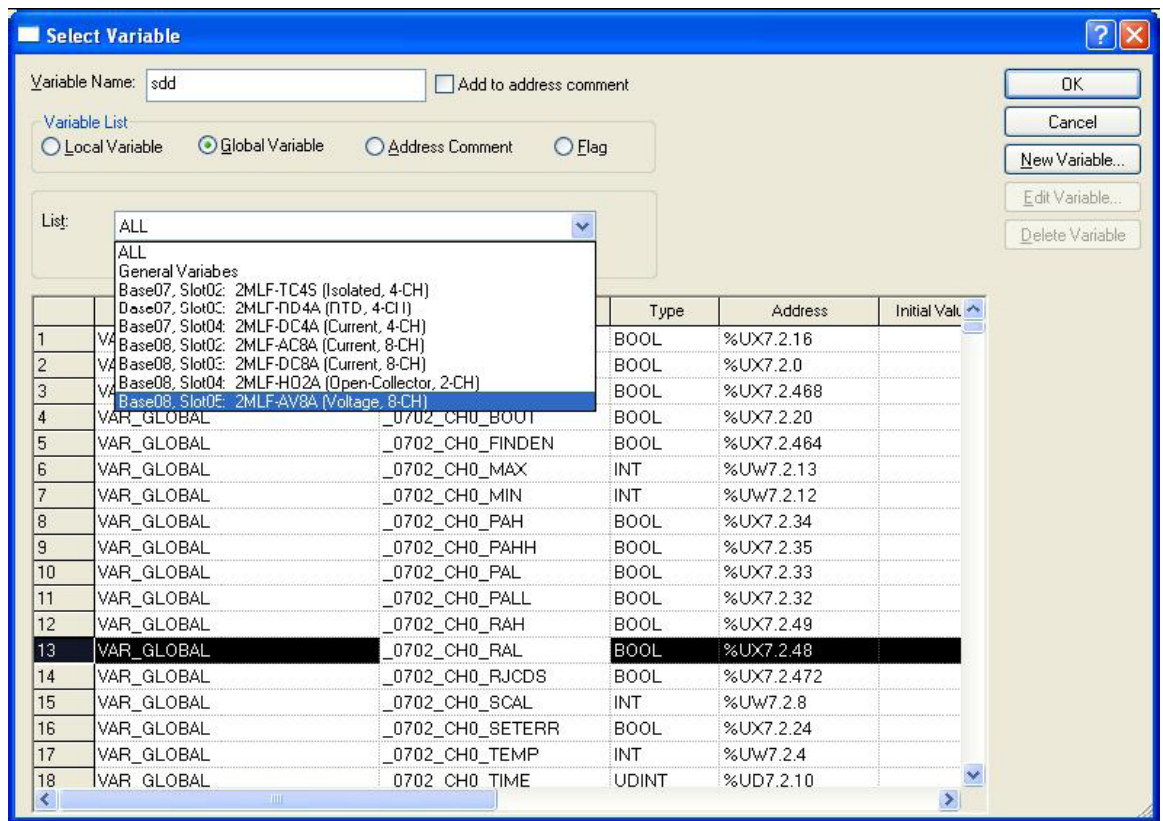

5. Configuration and Function of Internal Memory

5.4. Global variable (data area)

- Double-click or select `_0805_CH4_DATA` corresponding to CH4 A/D conversion data and click **OK**.

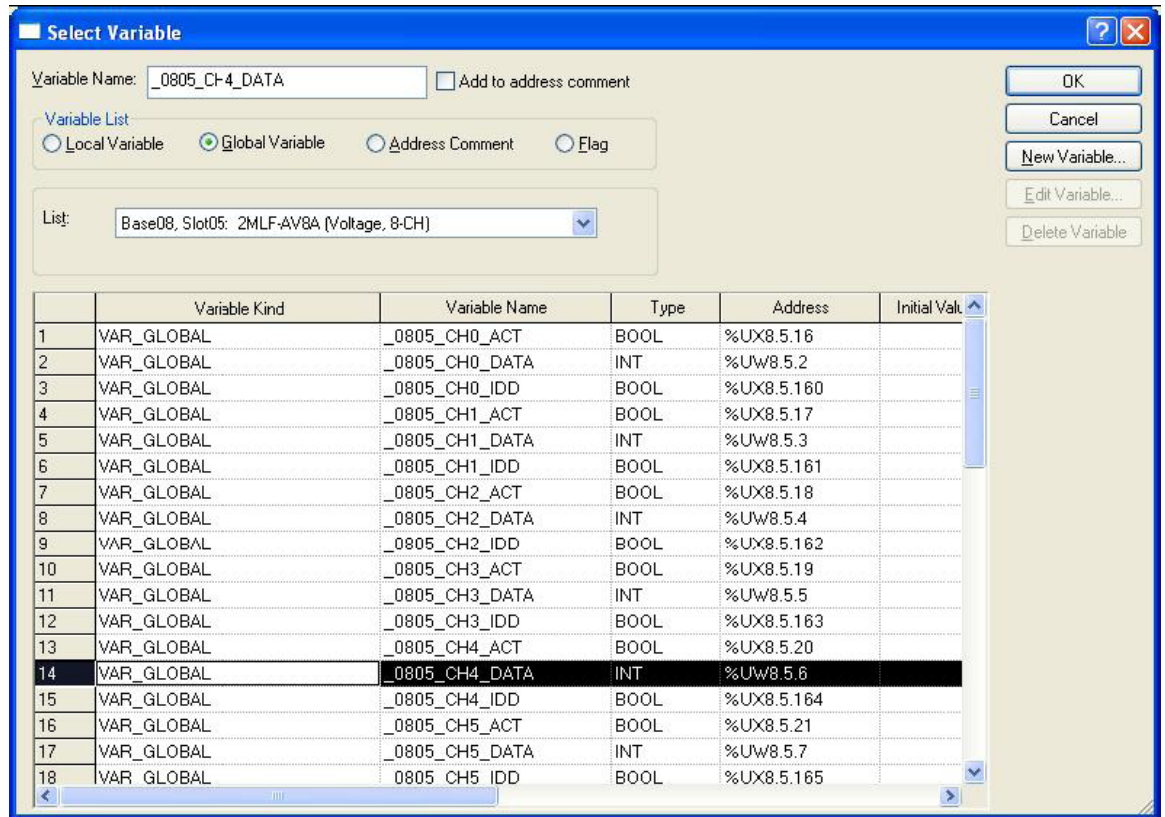

- The following figure is the result of adding global variable corresponding to CH0 A/D conversion value.

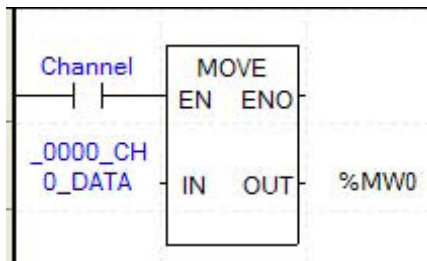

5. Configuration and Function of Internal Memory
5.5. PUT/GET function block use area (parameter area)

5.5 PUT/GET function block use area (parameter area)

The following table describes operation parameter setting area of A/D conversion module.

Global Variable	Contents	Read/Write	Instruction
_Fab_CH_EN	Channel Enable/Disable	Read/Write	PUT
_Fab_IN_RANGE	Input current/voltage ranges setting	Read/Write	PUT
_Fab_DATA_TYPE	Output data type setting	Read/Write	PUT
_Fab_FILT_EN	Filter processing enable/disable setting	Read/Write	PUT
_Fab_CH0_FILT_CON ST	CH0 filter constant setting	Read/Write	PUT
_Fab_CH1_FILT_CON ST	CH1 filter constant setting		
_Fab_CH2_FILT_CON ST	CH2 filter constant setting		
_Fab_CH3_FILT_CON ST	CH3 filter constant setting		
_Fab_CH4_FILT_CON ST	CH4 filter constant setting		
_Fab_CH5_FILT_CON ST	CH5 filter constant setting		
_Fab_CH6_FILT_CON ST	CH6 filter constant setting		
_Fab_CH7_FILT_CON ST	CH7 filter constant setting		
_Fab_AVG_EN	Average processing enable/disable setting	Read/Write	PUT

5. Configuration and Function of Internal Memory
5.5. PUT/GET function block use area (parameter area)

Global Variable	Contents	Read/Write	Instruction
_Fab_AVG_SEL	Average processing method setting	Read/Write	
_Fab_CH0_AVG_VAL	CH0 average value setting	Read/Write	
_Fab_CH1_AVG_VAL	CH1 average value setting		
_Fab_CH2_AVG_VAL	CH2 average value setting		
_Fab_CH3_AVG_VAL	CH3 average value setting		
_Fab_CH4_AVG_VAL	CH4 average value setting		
_Fab_CH5_AVG_VAL	CH5 average value		
_Fab_CH6_AVG_VAL	CH6 average value setting		
_Fab_CH7_AVG_VAL	CH7 average value setting		
_Fab_ERR_CODE	Error codes	Read/Write	GET

At device allocation, 'a' means base number and 'b' means slot number where module is equipped.

PUT instruction

Using PUT instruction, write data to special module.

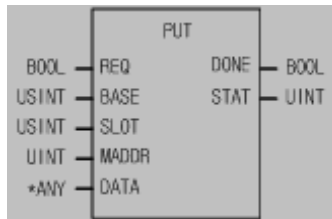

*ANY: WORD, DWORD, INT, USINT, DINT, UDINT type available among ANY type

5. Configuration and Function of Internal Memory

5.5. PUT/GET function block use area (parameter area)

Input

REQ: execute function when 1

BASE: set base position

SLOT: set slot position

MADDR: module address

DATA: data to save module

Output

DONE: Output 1 when normal

STAT: Error information

Function

This instruction is used for reading data from designated special module.

Function Block	Input (ANY) Type	Description
PUT_WORD	WORD	Save WRD data into the designated module address (MADDR).
PUT_DWORD	DWORD	Save DWORD data into the designated module address (MADDR).
PUT_INT	INT	Save INT data into the designated module address (MADDR).
PUT_UINT	UINT	Save UNIT data into the designated module address (MADDR).
PUT_DINT	DINT	Save DINT data into the designated module address (MADDR).
PUT_UDINT	UDINT	Save UDINT data into the designated module address (MADDR).

5. Configuration and Function of Internal Memory
5.5. PUT/GET function block use area (parameter area)

GET instruction

Using GET instruction, read from special module data.

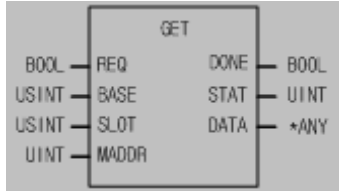

*ANY: WORD, DWORD, INT, UINT, DINT, UDINT type available among ANY type

Input

- REQ: execute function when 1
- BASE: set base position
- SLOT: set slot position
- MADDR: module address
512(0x200) ~ 1023(0x3FF)

Output

- DONE: output 1 when normal
- STAT: Error information
- DATA: data to read from module

Function

This instruction is used for reading data from designated special module.

Function Block	Output (ANY) Type	Description
GET_WORD	WORD	Read data as much as WORD from the designated module address (MADDR).
GET_DWORD	DWORD	Read data as much as DWORD from the designated module address (MADDR).

5. Configuration and Function of Internal Memory
5.5. PUT/GET function block use area (parameter area)

Function Block	Output (ANY) Type	Description
GET_INT	INT	Read data as much as INT from the designated module address (MADDR).
GET_UINT	UINT	Read data as much as UNIT from the designated module address (MADDR).
GET_DINT	DINT	Read data as much as DINT from the designated module address (MADDR).
GET_UDINT	UDINT	Read data as much as UDINT from the designated module address (MADDR).

Example using PUT/GET instruction

Enable channel

1. You can enable/disable A/D conversion per channel.
2. Disable channel to reduce the conversion cycle per channel.
3. When channels not designated, all channels are set as not used.
4. Enable/disable of A/D conversion is as follows.

B15	B14	B13	B12	B11	B10	B9	B8	B7	B6	B5	B4	B3	B2	B1	B0
-	-	-	-	-	-	-	-	CH7	CH6	CH5	CH4	CH3	CH2	CH1	CH0

BIT	Description
0	Stop
1	Run

5. Configuration and Function of Internal Memory
5.5. PUT/GET function block use area (parameter area)

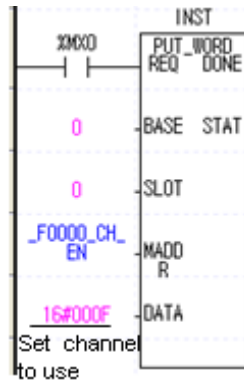
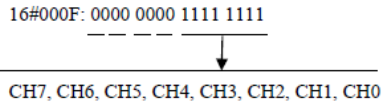

5. The value in B8~B15 is ignored.
6. The above figure is an example for enabling CH0~CH3 of A/D module equipped at slot 0.

Input voltage/current range setting

1. You can set input voltage/current range per channel.
2. When analog input range is not set, all channels are set as 1 ~ 5V (4 ~ 20mA).
3. Setting of analog input voltage/current range is as follows.
 - 2MLF-AV8A

The following is an example for setting CH0~CH3 as 1~5V and CH4~CH7 as 0~10V.

B15	B14	B13	B12	B11	B10	B9	B8	B7	B6	B5	B4	B3	B2	B1	B0
CH7		CH6		CH5		CH4		CH3		CH2		CH1		CH0	

BIT	Description
00	1V ~ 5V
01	0V ~ 5V

5. Configuration and Function of Internal Memory

5.5. PUT/GET function block use area (parameter area)

10	0V ~ 10V
11	-10V ~ 10V

16#AA00 : 1010 1010 0000 0000

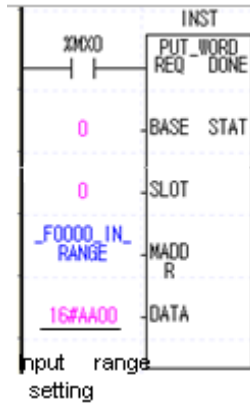
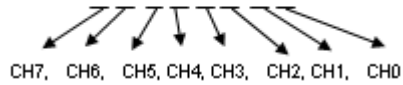

- 2MLF-AC8A

The following figure is an example for setting CH0~CH3 as 4~20mA and CH4~CH7 as 0~20mA.

B15	B14	B13	B12	B11	B10	B9	B8	B7	B6	B5	B4	B3	B2	B1	B0
CH7		CH6		CH5		CH4		CH3		CH2		CH1		CH0	

BIT	Description
00	4mA ~ 20mA
01	0mA ~ 20mA

5. Configuration and Function of Internal Memory
5.5. PUT/GET function block use area (parameter area)

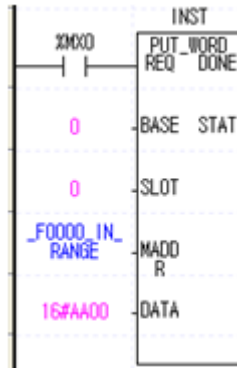
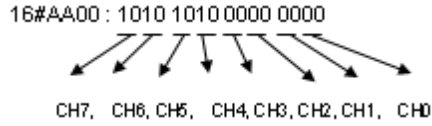

Output data range setting

1. Digital output data range for analog input can be set per channel.
2. When output data range is not set, all channels are set as 0~16000.
3. The following figure is an example for setting CH0~CH3 as -8000~8000, CH4~CH7 as 0~10000.

B15	B14	B13	B12	B11	B10	B9	B8	B7	B6	B5	B4	B3	B2	B1	B0
CH7		CH6		CH5		CH4		CH3		CH2		CH1		CH0	

BIT	Description
00	Unsigned value:0 ~ 16000
01	Signed value:-8000 ~ 8000
10	Precise value
11	Percentile value:0 ~ 10000

5. Configuration and Function of Internal Memory
5.5. PUT/GET function block use area (parameter area)

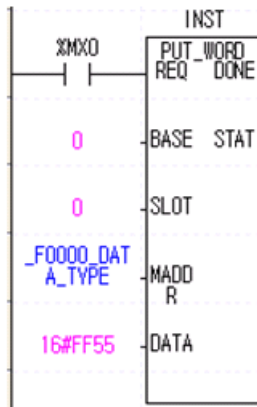
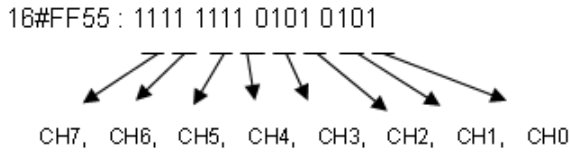

Precise value has the following digital output range for analog input range.

- 2MLF-AV8A

Analog input	-10 ~ 10V	0 ~ 10V	0 ~ 5V	-1 ~ 5V
Digital output				
Precise value	-10000 ~ 10000	0 ~ 10000	0 ~ 5000	1000 ~ 5000

- 2MLF-AC8A

Analog input	4 ~ 20mA	0 ~ 20mA
Digital output		
Precise value	4000 ~ 20000	0 ~ 20000

Filter process setting

1. You can enable/disable filter process per channel.
2. If filter process is not set; all channels are set as enable.
3. The following figure is an example for using filter CH4.

5. Configuration and Function of Internal Memory
5.5. PUT/GET function block use area (parameter area)

B15	B14	B13	B12	B11	B10	B9	B8	B7	B6	B5	B4	B3	B2	B1	B0
-	-	-	-	-	-	-	-	CH7	CH6	CH5	CH4	CH3	CH2	CH1	CH0

BIT	Description
0	Disable
1	Enable

16#0010 : 0000 0000 0001 0000
↓
 CH7, CH6, CH5, CH4, CH3, CH2, CH1, CH0

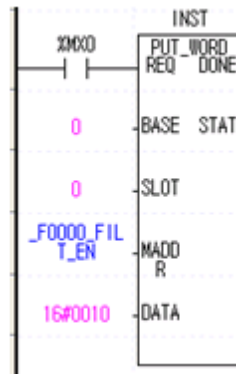

Filter constant setting

1. Initial value of filter constant is 1.
2. Setting range of filter constant is 1~99.
3. When setting value other than setting range, it indicates error number 50# at error code indication address (22). At this time, A/D conversion value keeps previous data. (# means the channel where error occurs at error code.)
4. If filter constant is not set; filter constant is set as '1'.
5. The following figure is an example for setting filter constant as 9 at channel 0.

5. Configuration and Function of Internal Memory
5.5. PUT/GET function block use area (parameter area)

B15	B14	B13	B12	B11	B10	B9	B8	B7	B6	B5	B4	B3	B2	B1	B0
-	-	-	-	-	-	-	-	CH# filter constant							

Address	Description
_Fab_CH0_FILT_CONST	CH0 filter constant setting
_Fab_CH1_FILT_CONST	CH1 filter constant setting
_Fab_CH2_FILT_CONST	CH2 filter constant setting
_Fab_CH3_FILT_CONST	CH3 filter constant setting
_Fab_CH4_FILT_CONST	CH4 filter constant setting
_Fab_CH5_FILT_CONST	CH5 filter constant setting
_Fab_CH6_FILT_CONST	CH6 filter constant setting
_Fab_CH7_FILT_CONST	CH7 filter constant setting

At device allocation, 'a' means base number, 'b' means slot number where module is equipped.



ATTENTION

For filter constant to be an effective value, enable the filter process.

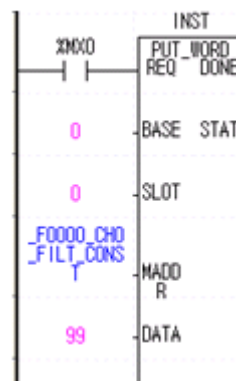

5. Configuration and Function of Internal Memory
5.5. PUT/GET function block use area (parameter area)

Average process setting

1. You can enable/disable average process per channel.
2. When disabling the average process, all channels are set as sampling process.
3. The following figure is an example for setting average process for channel 7.

B15	B14	B13	B12	B11	B10	B9	B8	B7	B6	B5	B4	B3	B2	B1	B0
-	-	-	-	-	-	-	-	CH7	CH6	CH5	CH4	CH3	CH2	CH1	CH0

BIT	Description
0	Disable
1	Enable

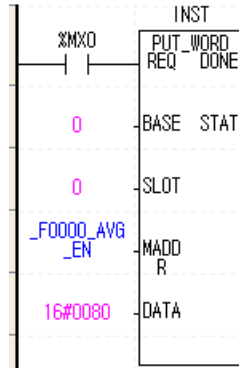
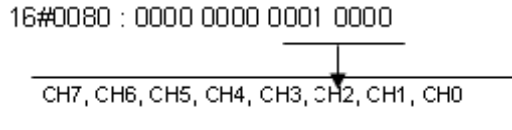

Average process method setting

1. In average process method, there are Count average, and Time average.
2. All channels execute average process by Count if Time/Count average process is not set.

5. Configuration and Function of Internal Memory

5.5. PUT/GET function block use area (parameter area)

3. The following figure is an example setting for CH0~CH3 as count average and CH4~CH7 as time average.

B15	B14	B13	B12	B11	B10	B9	B8	B7	B6	B5	B4	B3	B2	B1	B0
-	-	-	-	-	-	-	-	CH7	CH6	CH5	CH4	CH3	CH2	CH1	CH0

BIT	Description
0	Count average
1	Time average

16#00F0 : 0000 0000 1111 0000

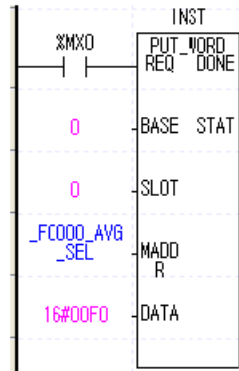
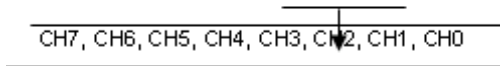

ATTENTION

For setting average process by Time/Count, enable average process.

Average value setting

- Constant value setting range of Time/Count is as follows:
 - Time average setting range: 4 ~ 16000 (ms)
 - Count average setting range: 2 ~ 64000 (times)

5. Configuration and Function of Internal Memory
5.5. PUT/GET function block use area (parameter area)

2. In case of setting value other than setting range:
 - If time average setting range exceeds, then error number 60x shows up.
 - If count average setting range exceeds, then error number 70x shows up. At this time, initial value is applied and calculated.
3. If the Time/Count average process value is not set, initial value is applied and calculated (Time average: 4, Count average: 2).
4. The following figure is an example for setting count average as 30 at channel 1.

B15	B14	B13	B12	B11	B10	B9	B8	B7	B6	B5	B4	B3	B2	B1	B0
-	-	-	-	-	-	-	-	CH# filter constant							

Address	Description
_Fab_CH0_AVG_VAL	CH0 average process value setting
_Fab_CH1_AVG_VAL	CH1 average process value setting
_Fab_CH2_AVG_VAL	CH2 average process value setting
_Fab_CH3_AVG_VAL	CH3 average process value setting
_Fab_CH4_AVG_VAL	CH4 average process value setting
_Fab_CH5_AVG_VAL	CH5 average process value setting
_Fab_CH6_AVG_VAL	CH6 average process value setting
_Fab_CH7_AVG_VAL	CH7 average process value setting
_Fab_CH0_AVG_	VAL CH0 average process value setting

At device allocation, 'a' means base number, 'b' means slot number, where module is installed.

5. Configuration and Function of Internal Memory
5.5. PUT/GET function block use area (parameter area)

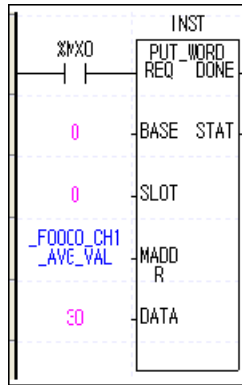

ATTENTION

For setting Time/Count average process value, enable average process..

Error code

1. Saves error code detected at A/D conversion module.
2. The following figure is a program example for reading error code

B15	B14	B13	B12	B11	B10	B9	B8	B7	B6	B5	B4	B3	B2	B1	B0			
-	-	-	-	-	-	-	-	Error Code										

Error Code (Decimal)	Error Contents	Remark
0	Normal RUN	RUN LED on
20	Module error (A/D Conversion Error)	RUN LED flickers every 0.2s
40#	Offset value of 1~5V (4~20mA) range is set as larger or equal than gain value	

5. Configuration and Function of Internal Memory

5.5. PUT/GET function block use area (parameter area)

Error Code (Decimal)	Error Contents	Remark
41#	Offset value of 0~5V (0~20mA) range is set as larger or equal than gain value	
42#	Offset value of 0~10V range is set as larger or equal than gain value	RUN LED flickers every 1s
43#	Offset value of -10~10V range is set as larger or equal than gain value	
50#	Filter constant setting range exceeded	
60#	Time average setting range exceeded	
70#	Count average setting range exceeded	
80#	Analog input range setting error	Applied at 2MLF-AC8A

At error code, # indicates channel where error occurs.



REFERENCE - INTERNAL

For more details on error code, refer to section [Error Codes](#).

- In case, two error code occurs, module saves first occurred error code and later occurred error code is not saved
- In case error occurs, after modifying error, use error clear request flag, restart power to delete error code and stop LED flicker. For more details about error clear request flag, refer to [Error Clear request Flag \(%UXa.b.176, a: Base No, b: Slot No.\)](#).

6. Programming

6.1 Read/Write of operation parameter settings area

The below program examples of read/write commands (GET/PUT) for data transfer between CPU and I/O module. For example, configuration of internal memory, and so on.

Read operation parameters settings area (GET, GETP command)

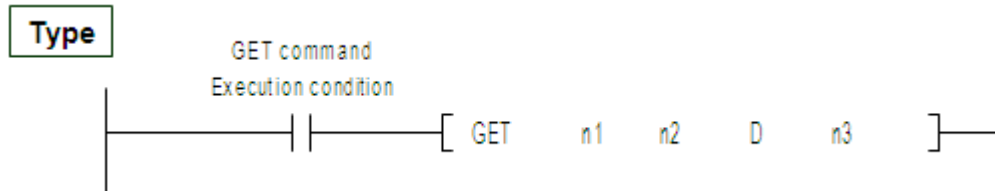

Type	Description	Area available
n1	Slot number where the special module is installed	Integer
n2	Start address of setting area of special module's Run parameters to read data.	Integer
D	Device's start address with saved data to read	M, P, K, L, T, C, D, #D
n3	Number of words data to read	Integer

< Difference between GET command and GETP command >

GET: Always executed with execution condition On ()

GETP: Executed with execution condition of operation start ()

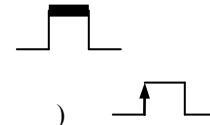

Example

The below program example reads A/D conversion module (Base 0, Slot 3) memory addresses 0 and 1 and transfers to D0 and D1 of CPU module.

6. Programming

6.1. Read/Write of operation parameter settings area

(Address) D area of CPU module		Internal memory (Address)	
D0	CH enable/disable setting	CH enable/disable setting	0
D1	Range setting of input voltage/ current	Range setting of input voltage/ current	1
	-	-	
	-	-	
	-	-	

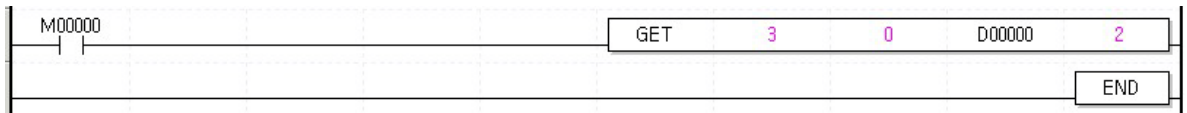

Write operation parameters settings area (PUT, PUTP command)

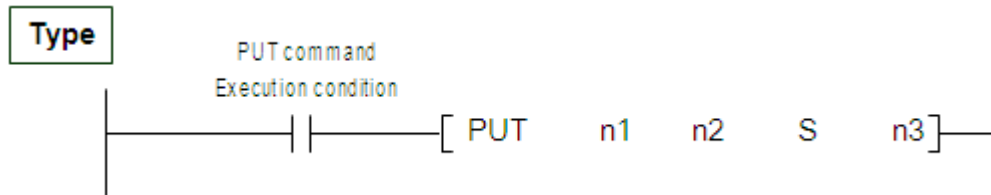

Type	Description	Area available
n1	Slot number where the special module is installed	Integer
n2	Start address of special module's internal memory to write data.	Integer
S	Device's start address or integer with saved data to write.	M,P,K,L,T,C,D,# D,integer
n3	Number of word data to write	Integer

< Difference between PUT command and PUTP command >

PUT: Always executed with execution condition On ()



PUTP: Executed with execution condition of operation start ()

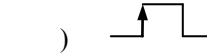

Example

6. Programming

6.1. Read/Write of operation parameter settings area

The below program example reads D10 ~ D13 of CPU module and writes to A/D conversion module (Base 0, Slot 6) memory addresses 12 ~ 15.

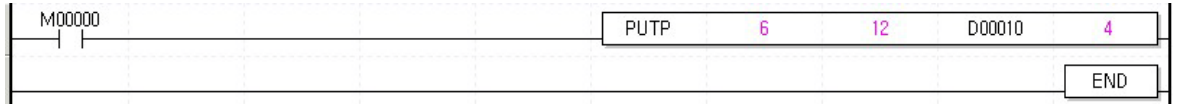
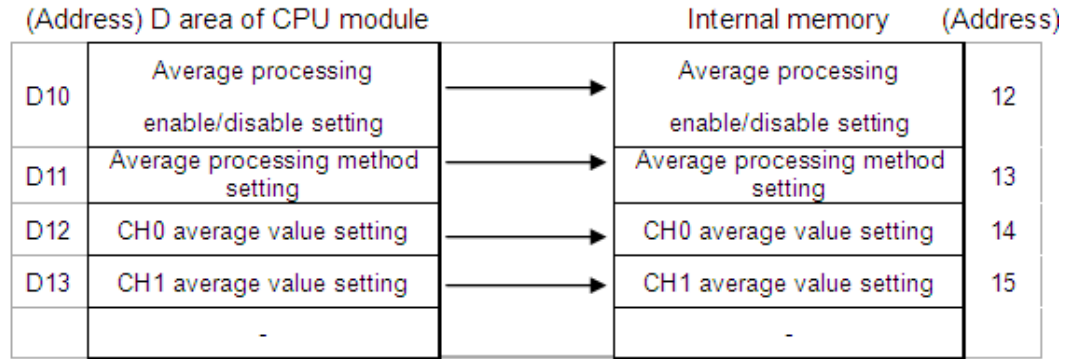

6. Programming

6.2. Configuring A/D module through program method

6.2 Configuring A/D module through program method

2MLF-AV8A

1. This program example accesses the A/D conversion value from CPU memory U02.02~U02.09 (Base 0, Slot 2) and directly reads the error code from Address 22 in the module.

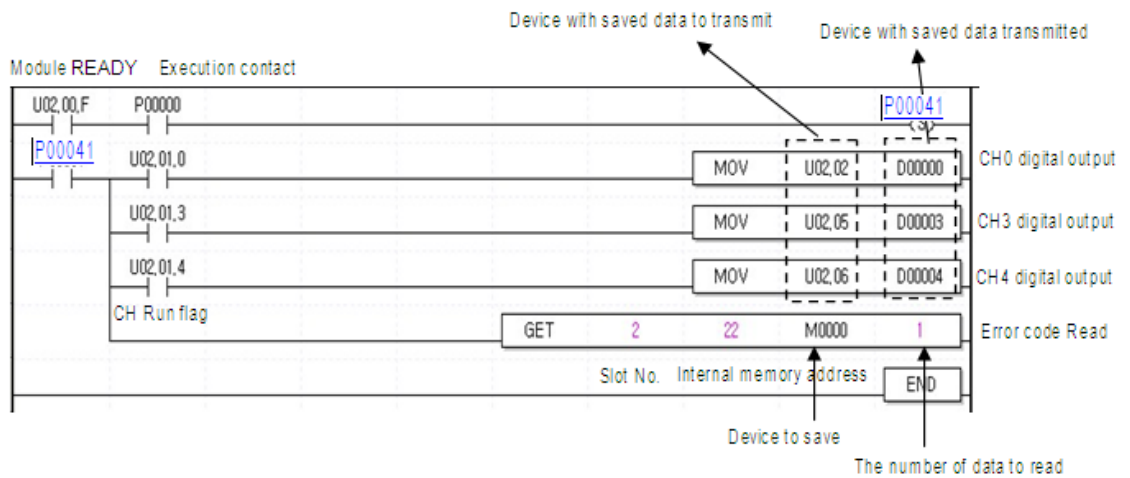

6. Programming

6.2. Configuring A/D module through program method

- This program example shows the procedure to configure the A/D voltage to digital conversion module by program method. That is, using PUT/GET commands to transfer data between CPU and module internal memory.

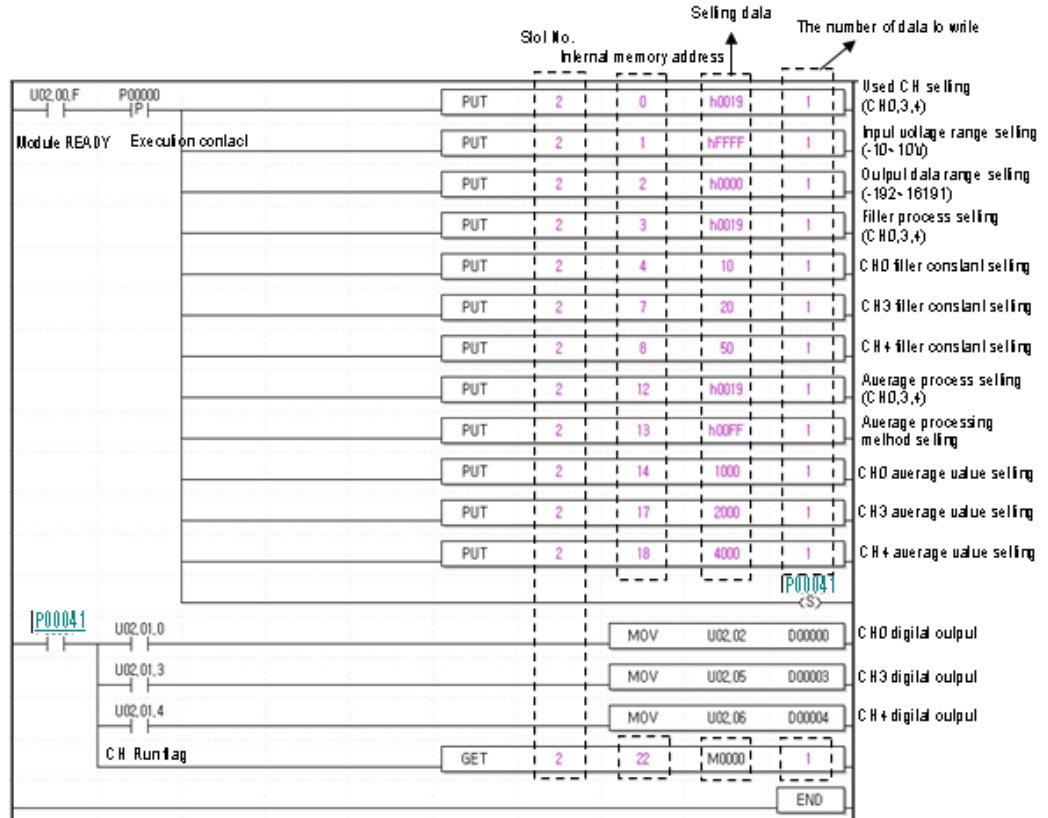

2MLF-AC8A

This program example shows the procedure to configure the A/D current to digital conversion module by program method. That is, using PUT/GET commands to transfer data between CPU and module internal memory.

6. Programming

6.2. Configuring A/D module through program method

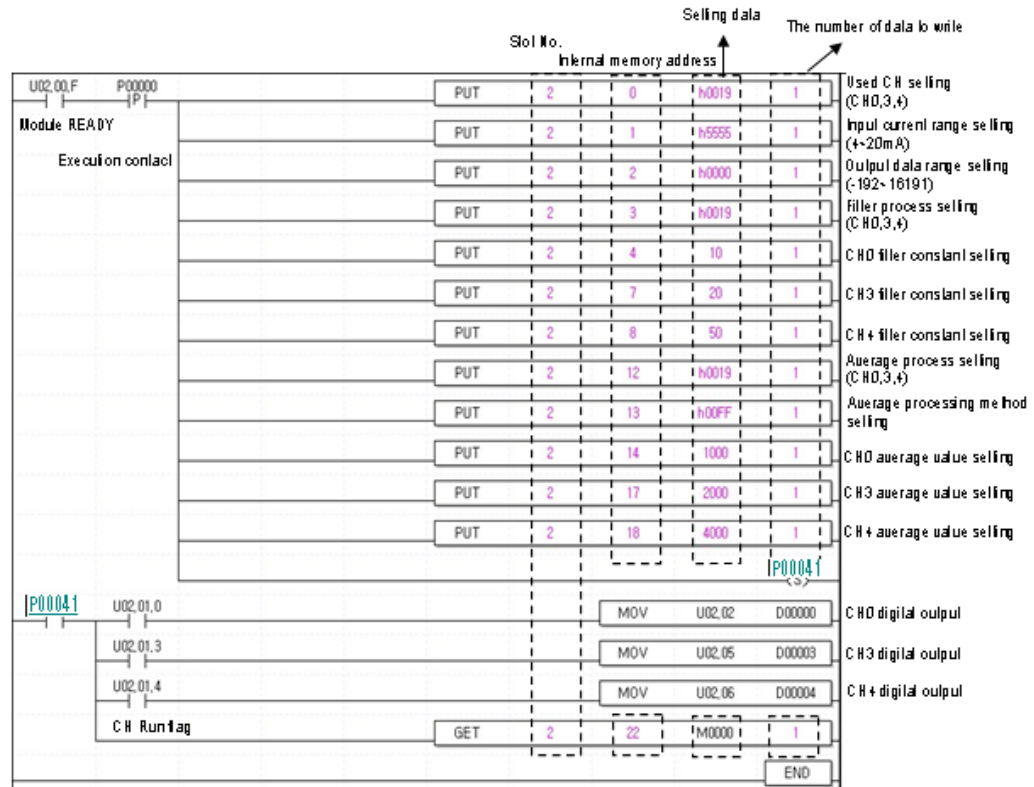

6.3 Basic program

- It describes about setting the operation condition at internal memory of A/D conversion module.
- A/D conversion module is equipped at slot 2.
- I/O occupation points of A/D conversion module are 16 points (fixed type).
- Initial setting condition is saved at internal memory by 1 time input.

2MLF-AV8A

1. Program example using I/O Parameter.

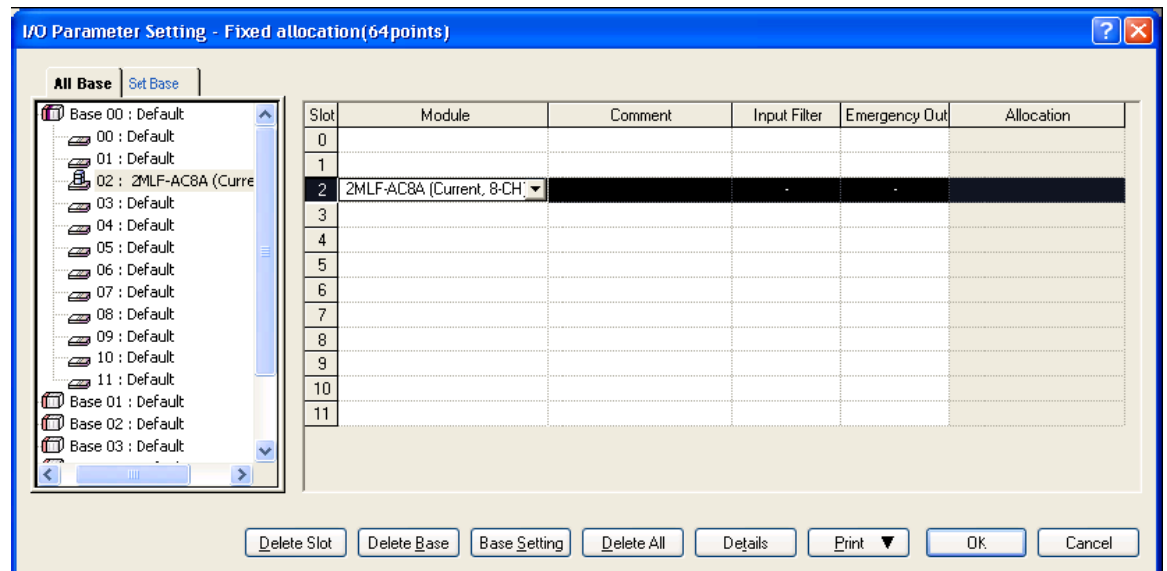

6. Programming
6.3. Basic program

2MLF-AC8A (Current, 8-CH) ? X

2MLF-AC8A (Current, 8-CH)

Parameter	CH 0	CH 1	CH 2	CH 3	CH 4	CH 5	CH 6	CH 7
<input type="checkbox"/> Input range	4~20mA	4~20mA	4~20mA	4~20mA	4~20mA	4~20mA	4~20mA	4~20mA
Output type	0~16000	0~16000	0~16000	0~16000	0~16000	0~16000	0~16000	0~16000
<input type="checkbox"/> Filter process	Enable	Disable	Disable	Enable	Enable	Disable	Disable	Disable
Filter constant	10	1	1	20	50	1	1	1
<input type="checkbox"/> Average setting	Enable	Disable	Disable	Enable	Enable	Disable	Disable	Disable
<input type="checkbox"/> Average processing	Time-Avr	Count-Avr	Count-Avr	Time-Avr	Time-Avr	Count-Avr	Count-Avr	Count-Avr
Average value	1000	2	2	2000	4000	2	2	2

2~64000 OK Cancel

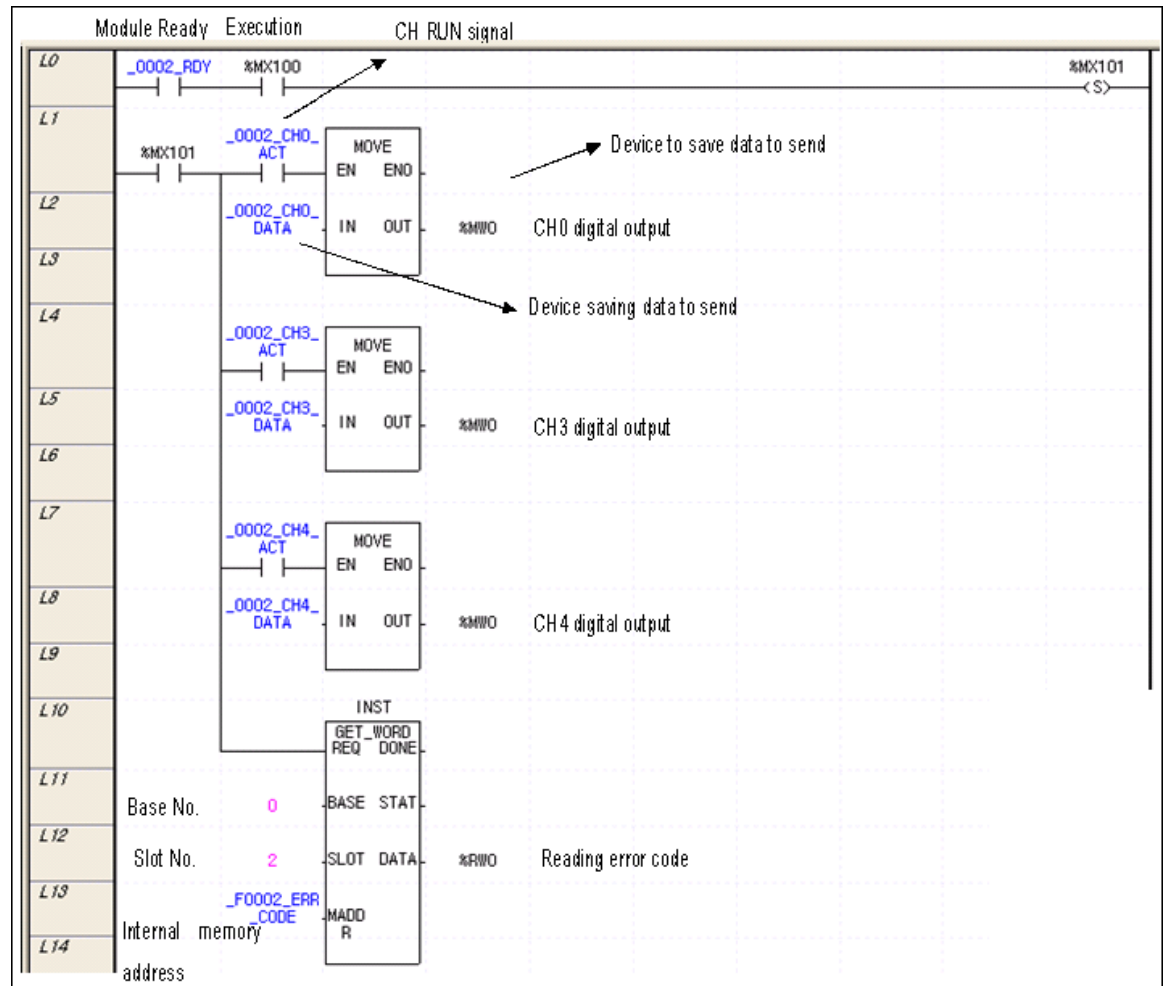

2. Program example using PUT/GET instruction.

6. Programming
6.3. Basic program

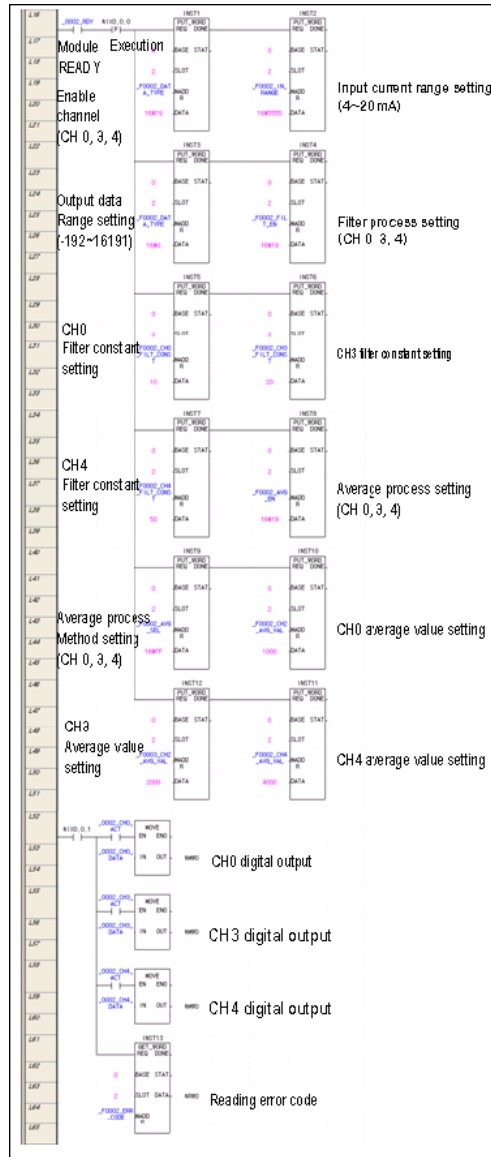

2MLF-AC8A

1. Program example using [I/O Parameter]

6. Programming
6.3. Basic program

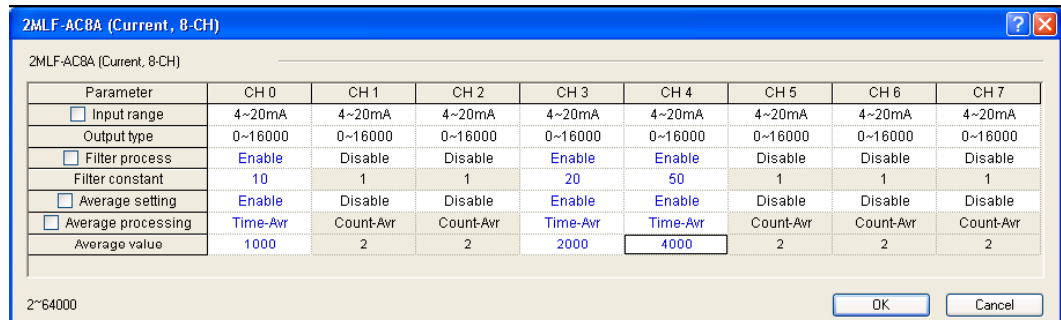
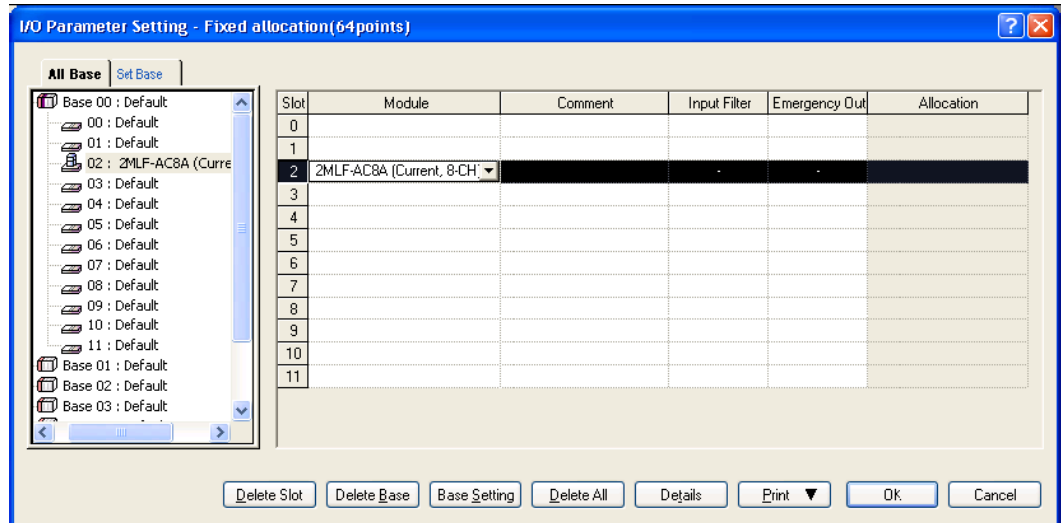

6. Programming
6.3. Basic program

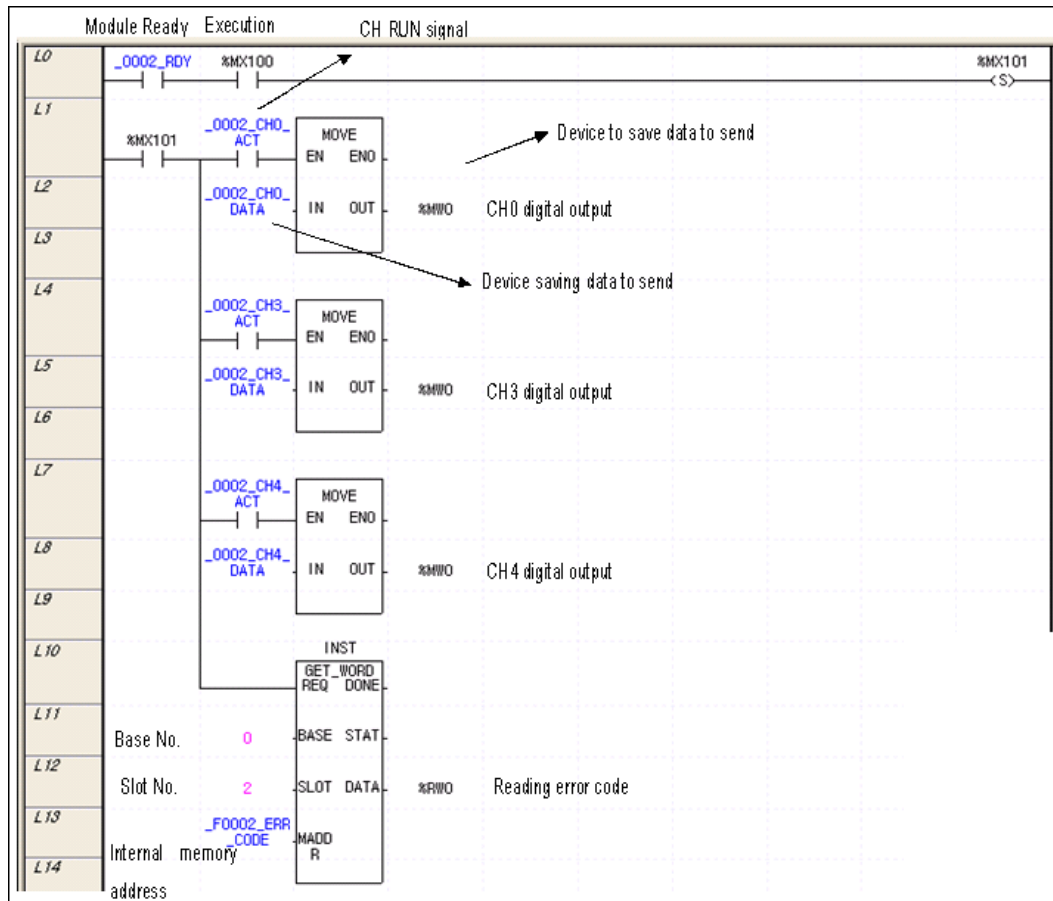

2. Program example using PUT/GET instruction

6. Programming
6.3. Basic program

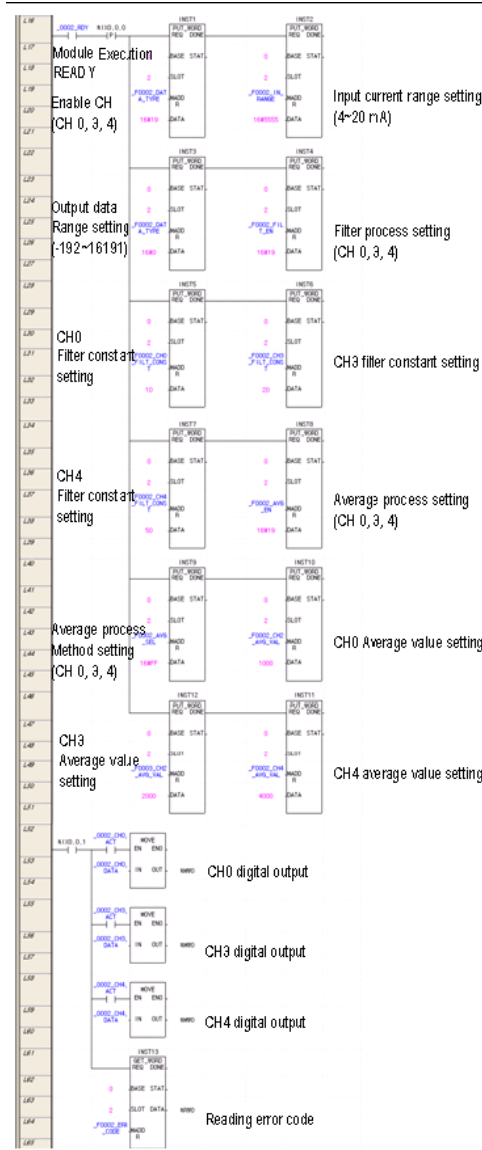

6. Programming

6.4. Application program examples

6.4 Application program examples

Program to compare A/D conversion values

The following figure shows system configuration.

2MLP- ACF2	2MLK- CPU	2MLI- D24A	2MLF- AV8A	2MLQ -	
---------------	--------------	---------------	---------------	-----------	--

Details of initial setting

No.	Item	Details of Initial Setting	Internal Memory Address	Value to Write on Internal Memory
1	Used CH	CH0, CH2, CH4	0	'h0015' or '21'
2	Input voltage range	-10 ~ 10V	1	'hFFFF' or '65535'
3	Output data range	0 ~ 16000	2	'h0000' or '0'
4	Filter process	CH0	3	'h0001' or '1'
5	CH0 filter constant	50	4	'h0032' or '50'
6	Average process	CH2, CH4	12	'h0014' or '20'
7	Average processing method	Frequency average: CH2 Time average: CH4	13	'h0010' or '16'
8	Average value	Frequency average value: 100 (times)	16	'h0064' or '100'
		Time average value: 200 (ms)	18	'h00C8' or '200'

Program description

1. If CH 0's digital value is less than 12000, Contact No. 0 (P00080) of relay output module installed on Slot No. 2 is ON.
2. If CH 2's digital value is greater than 13600, Contact No. 2 (P00082) of relay output module installed on Slot No. 2 is ON.
3. If CH 4's digital value is greater than or equal to 12000 and less than or equal to 13600, Contact No. 4 (P00084) of relay output module installed on Slot No. 2 is ON.
4. If CH 4's digital value is equal to 13600, Contact No. 5 (P00085) of relay output module installed on Slot No. 2 is ON.

Program

1. Program example using I/O Parameter.

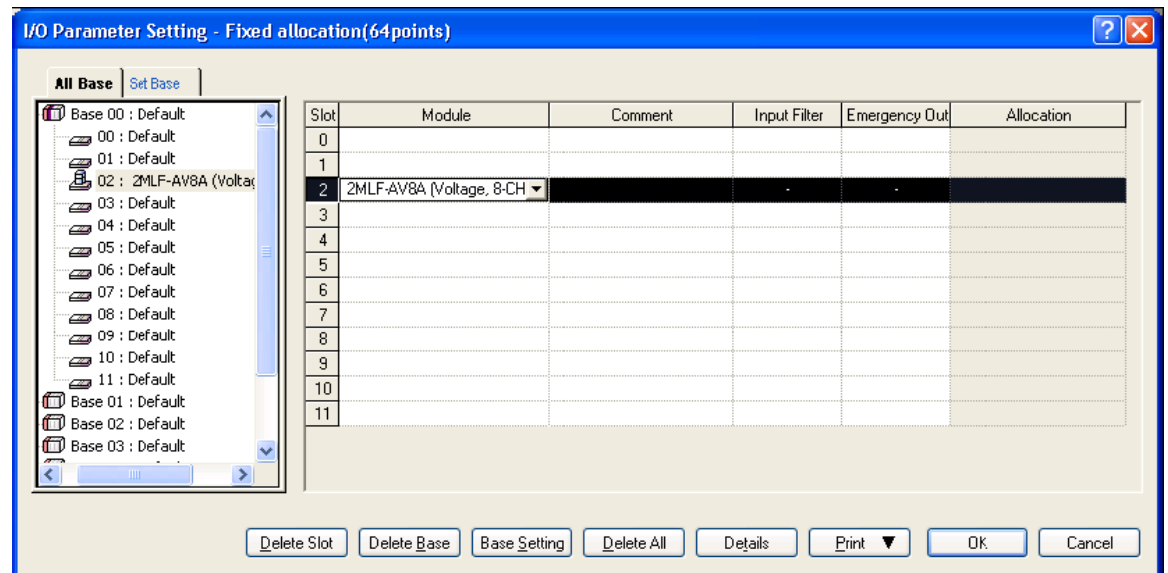

6. Programming

6.4. Application program examples

2MLF-AV8A (Voltage, 8-CH) ? X

2MLF-AV8A (Voltage, 8-CH)

Parameter	CH 0	CH 1	CH 2	CH 3	CH 4	CH 5	CH 6	CH 7
<input type="checkbox"/> Input range	-10~10V	1~5V	-10~10V	1~5V	-10~10V	1~5V	1~5V	1~5V
Output type	0~16000	0~16000	0~16000	0~16000	0~16000	0~16000	0~16000	0~16000
<input type="checkbox"/> Filter process	Enable	Disable	Disable	Disable	Disable	Disable	Disable	Disable
Filter constant	50	1	1	1	1	1	1	1
<input type="checkbox"/> Average setting	Disable	Disable	Enable	Disable	Enable	Disable	Disable	Disable
<input type="checkbox"/> Average processing	Count-Avr	Count-Avr	Count-Avr	Count-Avr	Count-Avr	Count-Avr	Count-Avr	Count-Avr
Average value	2	2	100	2	200	2	2	2

2~64000 OK Cancel

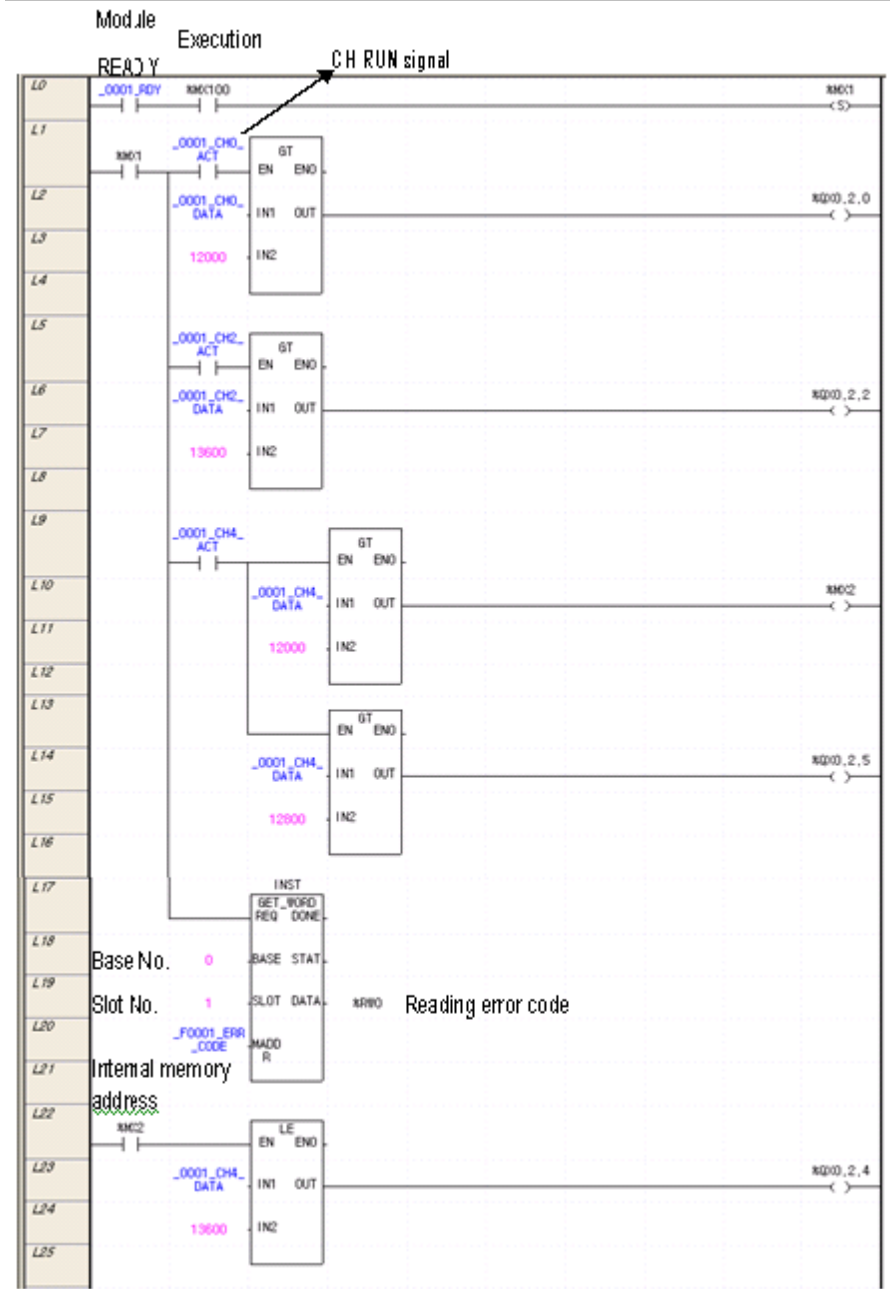

6. Programming

6.4. Application program examples

Program to output error codes of analog input module to BCD display

The following figure shows system configuration.

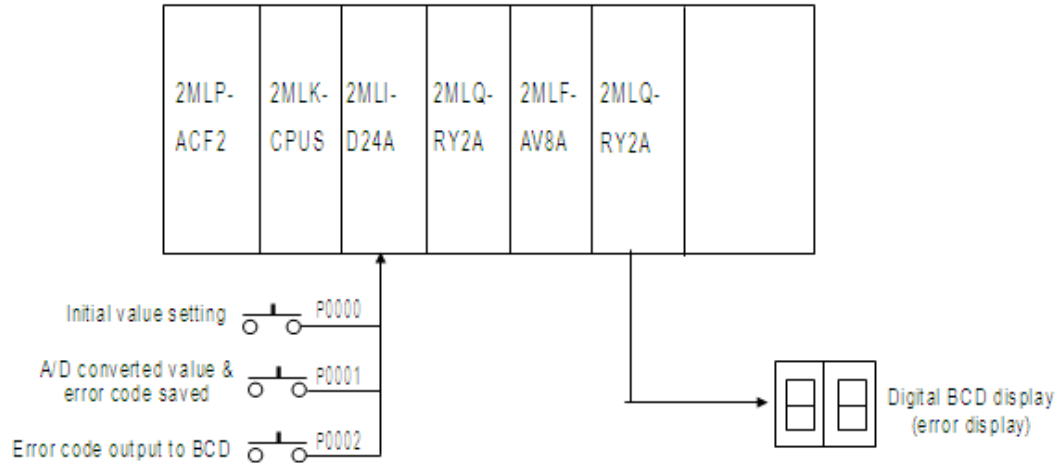

Details of initial setting

1. Used CH: CH 0
2. Analog input current range: DC 4 ~ 20mA
3. Time average process setting: 100ms
4. Digital output data range: 0 ~ 16000

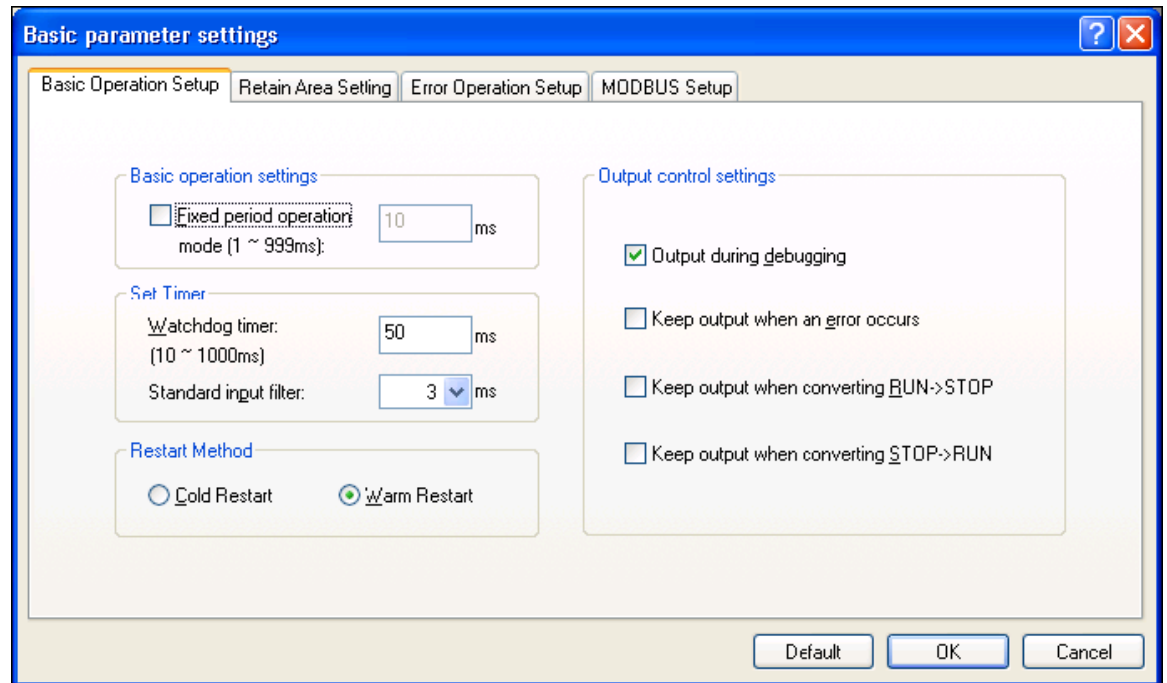

Program description

1. If P00000 is On, A/D conversion is initially specified.
2. If P00001 is On, A/D converted value and error code is saved, respectively, on D00000 and D00001.
3. If P00002 is ON, applicable error code is output to digital BCD display (P00040 ~ P0004F).

Program

Program example using I/O Parameter.

6. Programming

6.4. Application program examples

I/O Parameter Setting - Fixed allocation(64points)

All Base | Set Base

- Base C0 : Default
 - 00 : DC 24V INPUT, 16points
 - 01 : RELAY OUTPUT, 16points
 - 02 : 2MLF-AC8A (Current, 8-CH)
 - 03 : Default
 - 04 : Default
 - 05 : Default
 - 06 : Default
 - 07 : Default
 - 08 : Default
 - 09 : Default
 - 10 : Default
 - 11 : Default
- Base C1 : Default
- Base C2 : Default
- Base C3 : Default

Slot	Module	Comment	Input Filter	Emergency Out	Allocation
0	DC 24V INPUT, 16points		3 Standard (ms)	-	
1	RELAY OUTPUT, 16points		-	Default	
2	2MLF-AC8A (Current, 8-CH)		-	-	
3					
4					
5					
6					
7					
8					
9					
10					
11					

Delete Slot | Delete Base | Base Setting | Delete All | Details | Print ▼ | OK | Cancel

2MLF-AC8A (Current, 8-CH)

2MLF-AC8A (Current, 8-CH)

Parameter	CH 0	CH 1	CH 2	CH 3	CH 4	CH 5	CH 6	CH 7
<input type="checkbox"/> Input range	4~20mA	4~20mA	4~20mA	4~20mA	4~20mA	4~20mA	4~20mA	4~20mA
Output type	0~16000	0~16000	0~16000	0~16000	0~16000	0~16000	0~16000	0~16000
<input type="checkbox"/> Filter process	Disable	Disable	Disable	Disable	Disable	Disable	Disable	Disable
Filter constant	1	1	1	1	1	1	1	1
<input type="checkbox"/> Average setting	Enable	Disable	Disable	Disable	Disable	Disable	Disable	Disable
<input type="checkbox"/> Average processing	Time-Avr	Count-Avr	Count-Avr	Count-Avr	Count-Avr	Count-Avr	Count-Avr	Count-Avr
Average value	100	2	2	2	2	2	2	2

2~64000

OK | Cancel

6. Programming
6.4. Application program examples

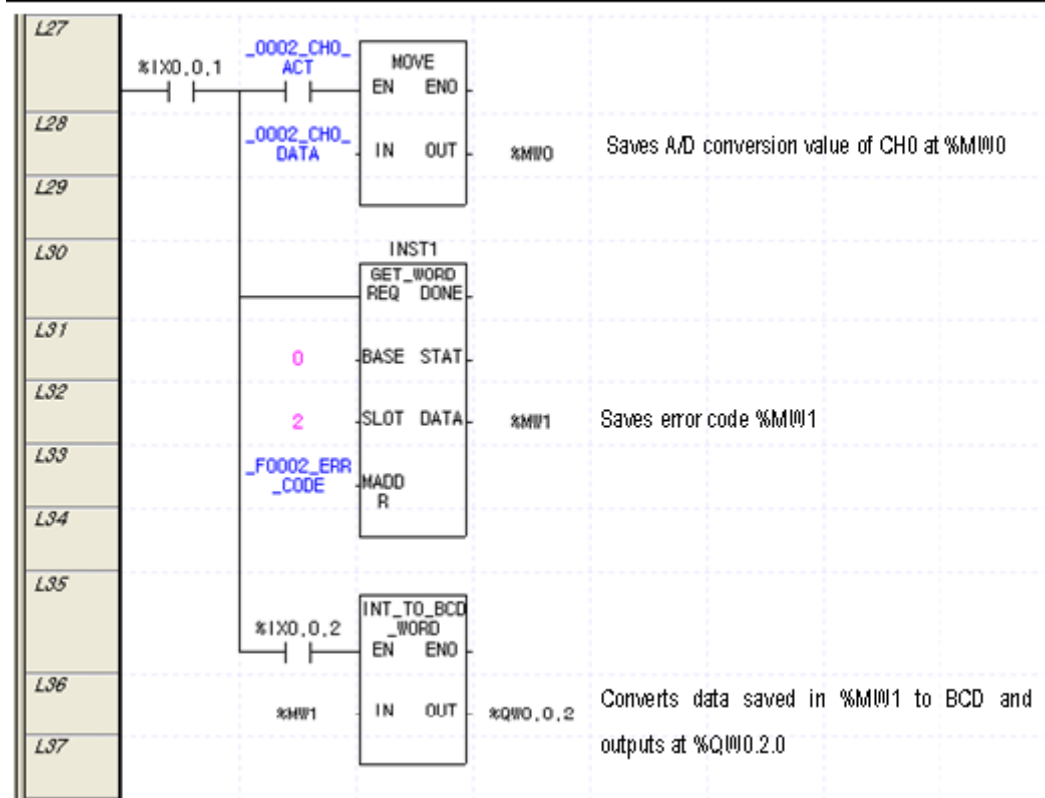

6. Programming

6.4. Application program examples

7. Troubleshooting

7.1 Error codes

Errors which occur when A/D conversion module's RUN LED blinks are as described in Table 7.

Table 7 – List of error codes

Error Code (Dec)	Description	RUN LED status
10	Module error (ASIC Reset Error).	Flickers every 0.2s.
11	Module error (ASIC RAM or Register Error).	
20	Module error (A/D Conversion Error).	
30	Module error (EEPROM Error).	
40#	Module error (Offset value with the range of 1 ~ 5V or 4 ~ 20mA is set greater than or equal to Gain value.)	Flickers every 1s.
41#	Module error (Offset value with the range of 0 ~ 5V or 0 ~ 20mA is set greater than or equal to Gain value.)	
42#	Module error (Offset value with the range of 0 ~ 10V is set greater than or equal to Gain value.)	
43#	Module error (Offset value with the range of -10 ~ 10V is set greater than or equal to Gain value.)	
50#	Filter constant setting range exceeded.	
60#	Time average setting range exceeded.	
70#	Count average setting range exceeded.	
80#	Analog input range setting error (only for 2MLF-AC8A).	

7. Troubleshooting

7.1. Error codes



ATTENTION

1. # of the error code stands for the channel with error found.
 2. If two or more errors occur, the module saves only the first error code.
 3. When the error is found and corrected, use the 'flag to request error clear'. For more information, refer Error Clear request Flag (UXY.11.0, X: Base No., Y: Slot No); or restart the unit. This stops the blinking LED and has the unit ready to detect the next error code.
-

7.2 Troubleshooting

RUN LED blinks

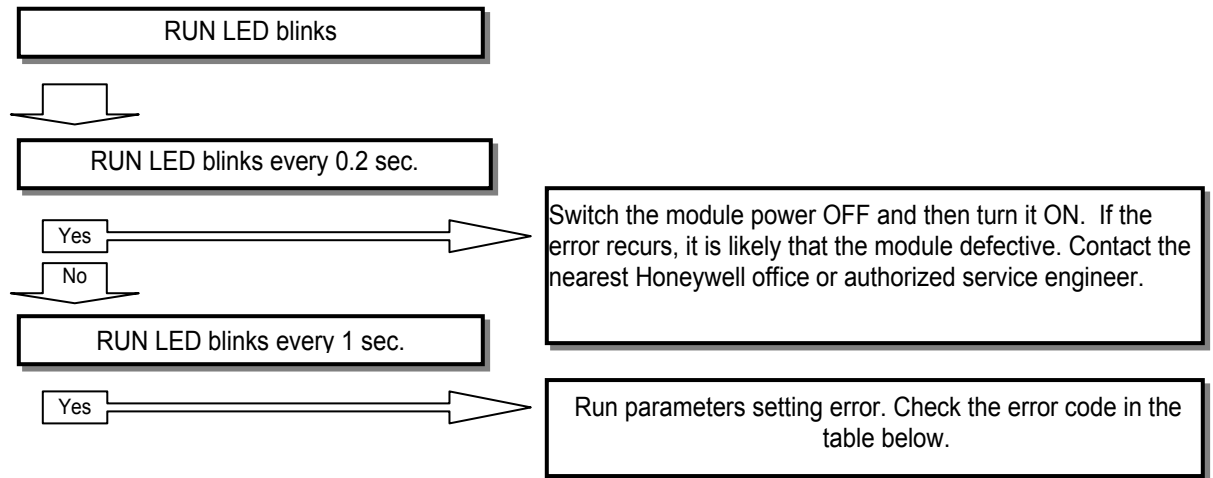

Error Code (Dec)	Error Details	Action
40#	Module Offset/Gain error	Turn the power ON/OFF. If the error recurs, it is likely that the module is defective. Contact the nearest Honeywell agency or branch office.
41#		
42#		
43#		
50#	Filter constant setting range exceeded	Change filter constant setting value within 1 ~ 99.
60#	Time average setting range exceeded	Change time average setting value within 4 ~ 16000.
70#	Frequency average setting range exceeded	Change frequency average setting value within 2 ~ 64000.
80#	Analog input range error (Only 2MLF-AC8A)	Refer to Address 1- input Voltage/Current section and then change the analog input range.

7. Troubleshooting
7.2. Troubleshooting

RUN LED is OFF

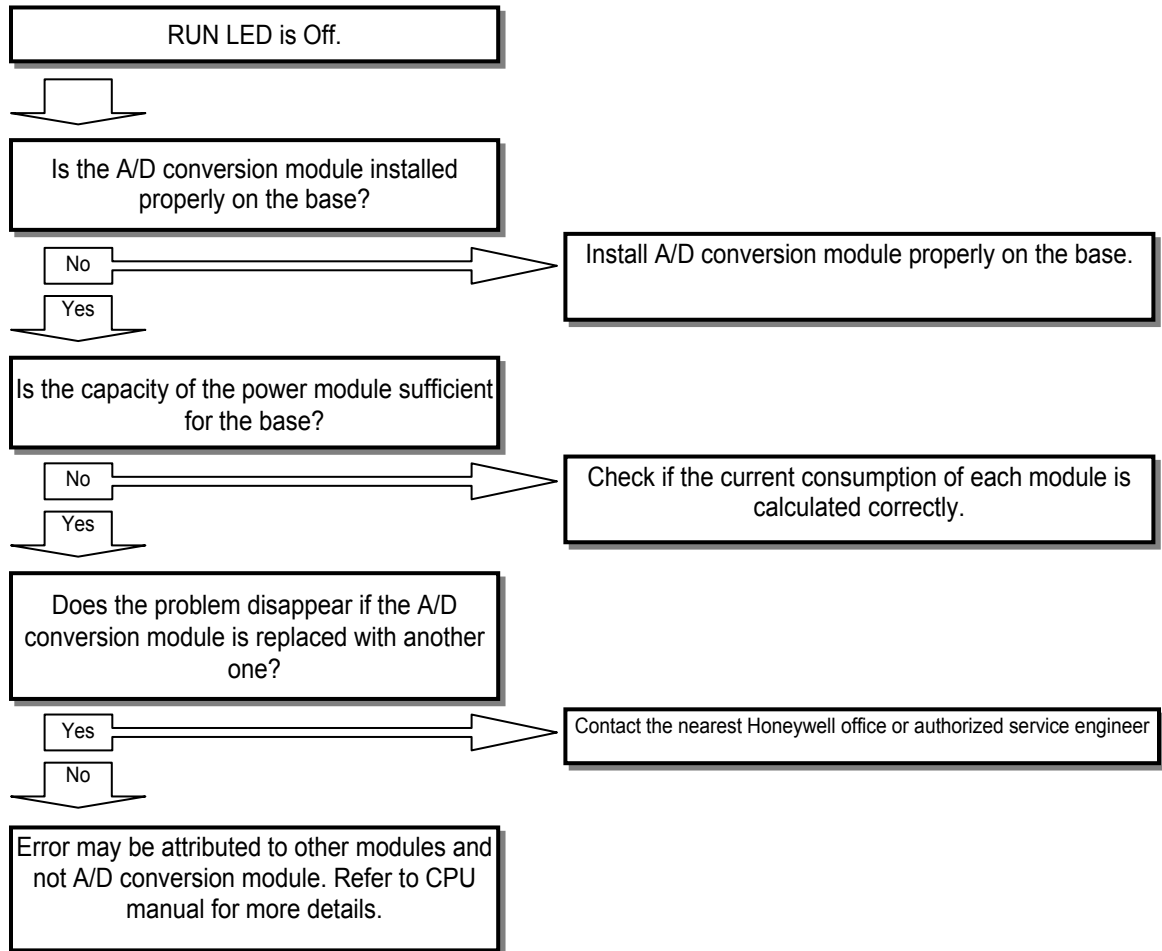

CPU module cannot read A/D conversion value

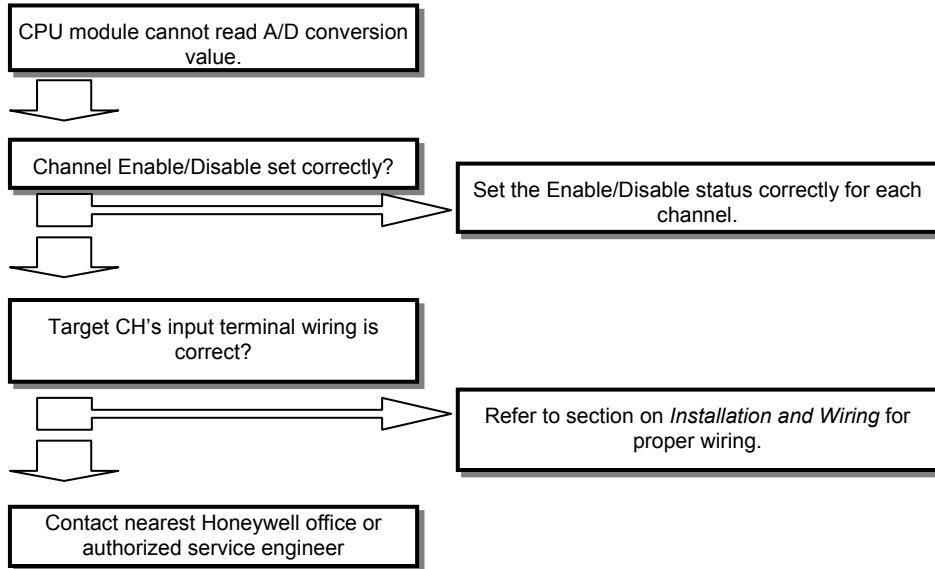

Mismatch between analog input value and digital output value

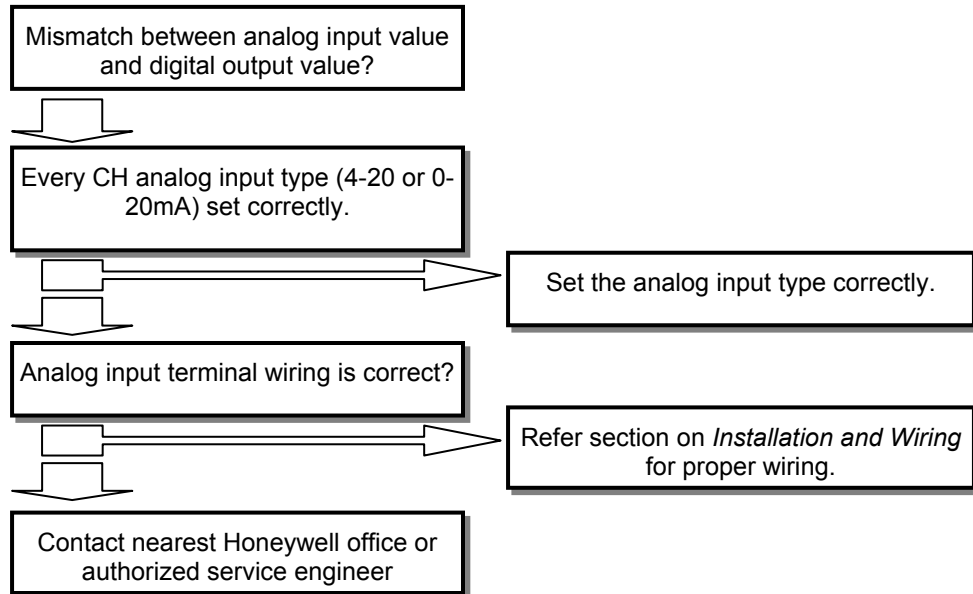

7. Troubleshooting

7.2. Troubleshooting

H/W error of A/D conversion module

Turn the module Power OFF and ON. If the error recurs, it is likely to be a module defect. Contact the nearest Honeywell office or authorized service engineer.

Status check of A/D conversion module using System Monitor menu

Module type, module information, O/S version, and module status of A/D conversion module can be checked through SoftMaster system monitoring function. For more details, refer to Section 4.3.

8. Appendix

8.1 Appendix 1: Terminology

Terms and abbreviation used in the user's guide and the analog module in general are as described below.

A/D Converter	Converts analog input signal (voltage or current) to a proportional digital output value (raw count).
Analog Input Module	The module that converts analog voltage/current input signal to proportional digital value. It has a resolution of 14 and 16 bits depending on the converter used.
Channel	The inputs to A/D converters are connected through channels. Each voltage or current input is on a different channel. Every analog input module will have many channels (typically 8 ~ 16). Thus, channel represents the circuitry used to connect input or output to an A/D or (D/A) converter.
Conversion time	Time taken by analog input module to sample and convert the analog input signal (one channel) into digital output value. Similarly, this term is also used to indicate the time required for analog output module to convert the digital value into an analog output signal.
D/A converter	Converts digital value to a proportional analog output signal (voltage or current, respectively).
Full Scale	The maximum value of the analog input (voltage or current) that can be converted by an A/D.
Full Scale Error	Difference between expected analog-converted value (voltage or current) and actual analog-converted value.
Full Scale Range	Difference between the maximum and the minimum value of the analog input (voltage or current).
LSB (Least Significant Bit)	The bit unit that gives minimum value (used in digital representation).

8. Appendix

8.1. Appendix 1: Terminology

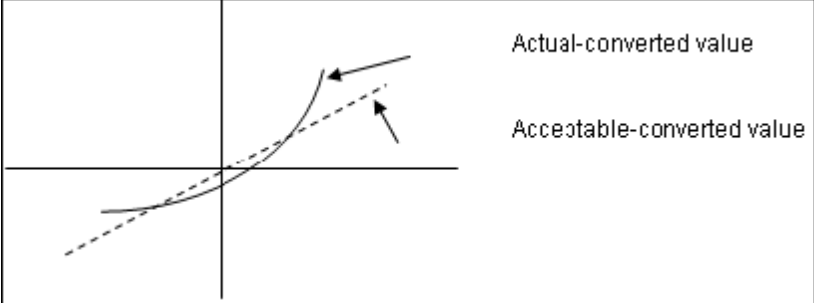
Linearity Error	Analog I/O is related to continuous voltage/current value and digital value. The acceptable I/O value is defined as a line within a distance of the minimum 1LSB of voltage/current. I/O linearity error is regarded as the deviation between the acceptable-converted value and the actual-converted value on the graph. See the following figure.
	
Multiplexer	A switching circuit where many signals share one A/D converter or D/A converter.
Analog Output Module	A module with output circuit to convert digital value from the process to analog output (voltage/current).
Resolution	The minimum value recognizable by a measuring instrument, which is usually displayed in the engineering unit (1mV) or the number of bits. So when there are 14 bits, 16383 output values can be generated.
Filter	Filters are used to avoid sudden changes in the digital value output caused either by external noise or sudden change in the analog input signal. Two types of filters used are: S/W and H/W filters.

Accuracy	Displays the maximum deviation between acceptable value and output value (voltage or current) for the full range of output. It also indicates the maximum deviation between acceptable value and digitally-converted input signal value for the full range of input. Generally, accuracy is displayed as percentage of the full scale value. Gain, offset, and linearity errors are all listed in the error codes generated.
Output accuracy	The difference between the actual analog output voltage/current value and the acceptable-converted value is indicated as percentage of full scale. It takes into account the effect of temperature, offset, gain, and drift error factors.

8.2 Appendix 2: External dimensions

External dimensions of 2MLF-AV8A/AC8A

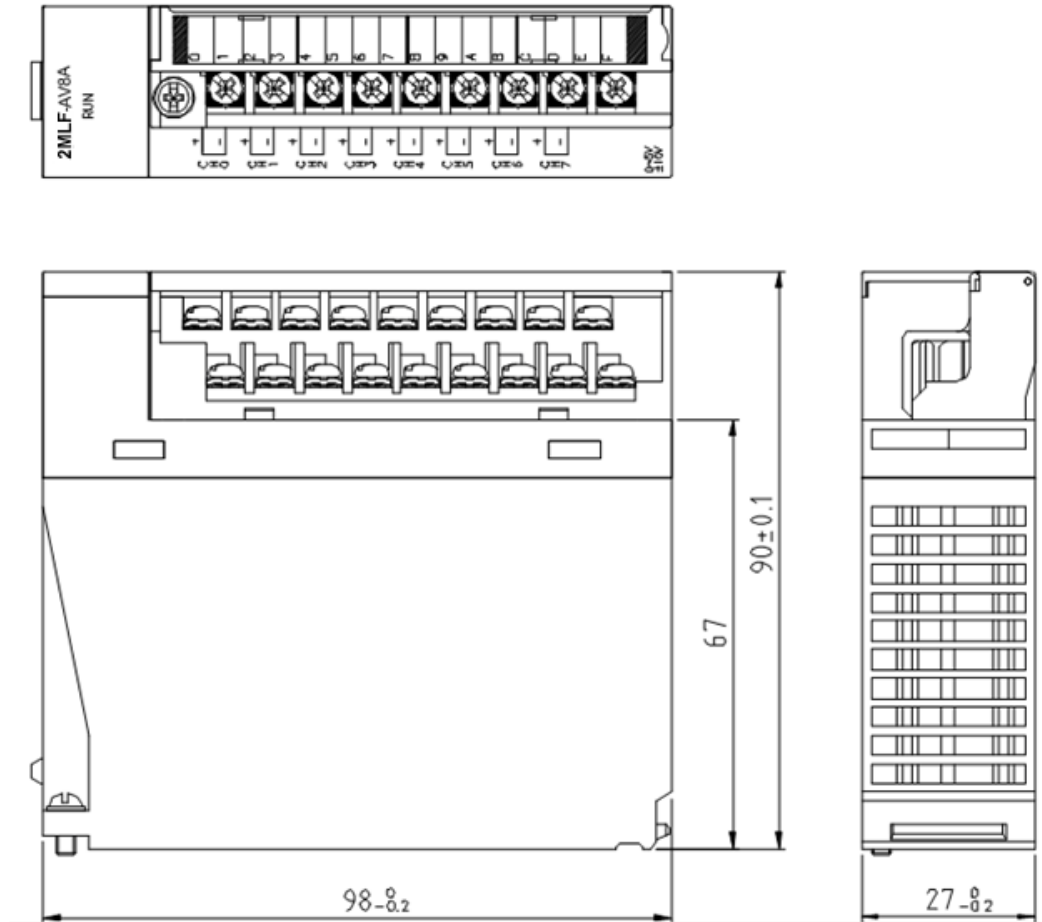

Honeywell

Honeywell Process Solutions
1860 W. Rose Garden Lane
Phoenix, AZ 85027 USA