

**Siemens**  
Energy & Automation, Inc.

# **Installation and Service Instruction**

**SD39VIM-2**  
Rev: 3  
July 1998  
(Updated April 2012)

## **APACS+ Voltage Input Module(VIM)**

## Changes Since Revision 1

Preface (Conventions and Symbols) - New Section

Product Support - Contact information updated

2.2 Considerations and Preparation - Danger Alert Added

2.2.2 Page 2-3a added.

3 Maintenance - Danger Alert Added

*Siemens Energy & Automation, Inc., assumes no liability for errors or omissions in this document or for the application and use of information included in this document. The information herein is subject to change without notice.*

*Procedures included in this document have been reviewed for compliance with applicable approval agency requirements and are considered sound practice. Neither Siemens Energy & Automation, Inc., nor these agencies are responsible for repairs made by the user.*

*ProcessSuite, QUADLOG, 4-mation, and APACS+ are trademarks of Siemens Energy & Automation, Inc. All other trademarks are the property of their respective owners.*

*© 2006 Siemens Energy & Automation, Inc. All rights reserved.*









---

---

## PREFACE

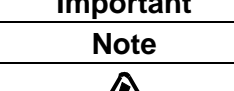
### Conventions and Symbols

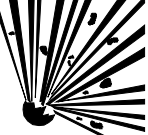
The following symbols may appear in this manual and may be applied to the equipment. The reader should become familiar with the symbols and their meaning. Symbols are provided to quickly alert the user to safety related situations, issues, and text.

Symbol	Meaning
	Indicates an immediate hazardous situation which, if not avoided, <i>will</i> result in death or serious injury.
	Indicates a potentially hazardous situation which, if not avoided, <i>could</i> result in death or serious injury.
	Indicates a potentially hazardous situation which, if not avoided, <i>may</i> result in minor or moderate injury.
	Indicates a potentially hazardous situation which, if not avoided, may result in property damage.
	Indicates a potential situation which, if not avoided, may result in an undesirable result or state.
	Identifies an action that should be taken to avoid an undesirable result or state.
	<b>Electrical shock hazard.</b> The included Warning text states that the danger of electrical shock is present.
	<b>Electrical shock hazard.</b> Indicated that the danger of electrical shock is present.
	<b>Explosion hazard.</b> Indicates that the danger of an explosion hazard exists.
	<b>Electrostatic discharge.</b> The presence of this symbol indicates that electrostatic discharge can damage the electronic assembly.

---

---

## Qualified Persons

The described equipment should be installed, configured, operated, and serviced only by qualified persons thoroughly familiar with this publication. The current version, in Portable Document Format (PDF), is available at <http://sightscape.sea.siemens.com/>.

For the purpose of this publication and product labels, a qualified person is one who is familiar with the installation, construction, and operation of the equipment, and the involved hazards. In addition, he or she has the following qualifications:

- Is trained and authorized to energize, de-energize, clear, ground and tag circuits and equipment in accordance with established safety practices.
- Is trained in the proper care and use of protective equipment such as rubber gloves, hard hat, safety glasses or face shields, flash clothing, etc., in accordance with established safety practices.
- Is trained in rendering first aid.

## Scope

This publication does not purport to cover all details or variations in equipment, nor to provide for every possible contingency to be met in connection with installation, operation, or maintenance. Should further information be desired or should particular problems arise which are not covered sufficiently for the purchaser's purposes, the matter should be referred to one of the support groups listed in the Product Support section of this manual.

The contents of this manual shall not become part of or modify any prior or existing agreement, commitment or relationship. The sales contract contains the entire obligation of Siemens. The warranty contained in the contract between the parties is the sole warranty of Siemens. Any statements continued herein do not create new warranties or modify the existing warranty.

## General Warnings and Cautions



This equipment contains hazardous voltages, and it has been certified for use in the hazardous locations specified on the product nameplate and in the Model Designation and Specifications section. Death, serious personal injury, or property damage can result if safety instructions are not followed. Only qualified personnel should work on or around this equipment after becoming thoroughly familiar with all warning, safety notices, and maintenance procedures contained herein. The successful and safe operation of this equipment is dependent upon proper handling, installation, operation, and maintenance.

The perfect and safe operation of the equipment is conditional upon proper transport, proper storage, installation and assembly, as well as, on careful operation and commissioning.

The equipment may be used only for the purposes specified in this publication.

---



---

**CAUTION**

Electrostatic discharge can damage or cause the failure of semiconductor devices such as integrated circuits and transistors. The symbol at right may appear on a circuit board or other electronic assembly to indicate that special handling precautions are needed.



- A properly grounded conductive wrist strap must be worn whenever an electronics module or circuit board is handled or touched. A service kit with a wrist strap and static dissipative mat is available from Siemens (PN15545-110). Equivalent kits are available from both mail order and local electronic supply companies.
- Electronic assemblies must be stored in anti-static protective bags when not installed in equipment.

 <b>DANGER</b>		
	<b>Electrical shock hazard</b> <b>Explosion hazard</b>  Will cause death, serious injury or property damage	
	<ul style="list-style-type: none"><li>• Remove power from all wires and terminals and verify that there are no hazardous voltages before working on equipment.</li><li>• In potentially hazardous atmosphere, remove power from equipment before connecting or disconnecting power, signal, or other circuit, or extracting/inserting module.</li><li>• Observe all pertinent regulations regarding installation in hazardous area.</li><li>• Ensure all devices are rated for hazardous (classified) locations.</li></ul>	



---

## TABLE OF CONTENTS

<b><u>SECTION</u></b>	<b><u>TITLE</u></b>	<b><u>PAGE</u></b>
<b>1.0</b>	<b>INTRODUCTION .....</b>	<b>1-1</b>
1.1	PRODUCT DESCRIPTION .....	1-1
1.1.1	Channel Types .....	1-4
1.1.2	Diagnostics .....	1-4
1.1.2.1	Overall Module Performance Diagnostics .....	1-4
1.1.2.2	Input Circuit Diagnostics .....	1-5
1.1.3	LED Indicators .....	1-5
1.1.4	Configuration .....	1-5
1.1.4.1	Thermocouple Input Channel Parameters .....	1-6
1.1.4.2	Voltage Input Channel Parameters .....	1-6
1.1.5	Terminations .....	1-6
1.2	PRODUCT SUPPORT .....	1-6
1.3	INTERNATIONAL STANDARDS ORGANIZATION (ISO) SYMBOLS .....	1-8
1.4	RELATED LITERATURE .....	1-9
<b>2.0</b>	<b>INSTALLATION .....</b>	<b>2-1</b>
2.1	HARDWARE IDENTIFICATION .....	2-1
2.1.1	Voltage Input Module (VIM) .....	2-1
2.1.2	VIM Local Termination Strip Identification .....	2-1
2.1.3	VIM Marshalled Termination Assembly Identification .....	2-2
2.2	CONSIDERATIONS AND PREPARATION .....	2-2
2.2.1	EMC Directive Installation Considerations .....	2-2
2.2.2	Preparations .....	2-2
2.3	ENVIRONMENTAL CONSIDERATIONS .....	2-3
2.4	EQUIPMENT DELIVERY AND HANDLING .....	2-4
2.4.1	Predelivery Test .....	2-4
2.4.2	Factory Shipment .....	2-4
2.4.3	Receipt of Shipment .....	2-4
2.4.4	Equipment Handling .....	2-4
2.4.5	Equipment Storage .....	2-5
2.5	VIM TERMINATION STRIP INSTALLATION .....	2-5
2.6	VIM MARSHALLED TERMINATION ASSEMBLY AND CABLE INSTALLATION .....	2-8
2.6.1	Marshalled Termination Assembly Installation .....	2-8
2.6.2	Optional (Flat Surface) Marshalled Termination Assembly Installation .....	2-13
2.6.3	Interconnect I/O Cable Installation .....	2-14
2.7	VIM INSTALLATION .....	2-16
2.7.1	Module and Module Rack Mechanical Keying .....	2-18
2.7.2	Module Installation .....	2-18

---

**TABLE OF CONTENTS (continued)**

<b><u>SECTION</u></b>	<b><u>TITLE</u></b>	<b><u>PAGE</u></b>
2.8	ELECTRICAL INSTALLATION .....	2-19
2.8.1	Field Input Wire Selection .....	2-19
2.8.2	Field Input Wiring Connections .....	2-20
2.8.3	Unterminated I/O Cable Assembly Connections .....	2-25
2.8.4	Configuration .....	2-25
2.9	APACS+ CALIBRATION VERIFICATION REQUIREMENTS—LONG TERM DRIFT	2-25
<b>3.0</b>	<b>MAINTENANCE .....</b>	<b>3-1</b>
3.1	TOOL AND EQUIPMENT REQUIREMENTS .....	3-1
3.2	VISUAL INSPECTION .....	3-1
3.3	CLEANING .....	3-1
3.4	TROUBLESHOOTING .....	3-1
3.5	VIM REMOVAL/REPLACEMENT .....	3-3
3.5.1	Removal .....	3-3
3.5.2	Replacement .....	3-3
3.6	VIM TERMINATION STRIP REMOVAL/REPLACEMENT .....	3-4
3.6.1	Removal .....	3-4
3.6.2	Replacement .....	3-4
3.7	VIM MARSHALLED TERMINATION ASSEMBLY REMOVAL/REPLACEMENT ...	3-4
3.7.1	Removal .....	3-4
3.7.2	Replacement .....	3-5
3.8	INTERCONNECT I/O CABLE ASSEMBLY REMOVAL/REPLACEMENT .....	3-5
3.8.1	Removal .....	3-5
3.8.2	Replacement .....	3-6
3.9	RETURN OF EQUIPMENT WITHIN NORTH AMERICA .....	3-6
3.10	RETURN OF EQUIPMENT OUTSIDE OF NORTH AMERICA .....	3-6
3.11	SPARE AND REPLACEMENT PARTS .....	3-7
3.12	MAINTENANCE RECORDS .....	3-7
<b>4.0</b>	<b>CIRCUIT DESCRIPTION .....</b>	<b>4-1</b>
4.1	THERMOCOUPLE INPUT CIRCUITRY .....	4-1
4.2	SENSOR SELECTION .....	4-3
4.3	MULTIPLEXING, AMPLIFYING, AND DIGITIZING .....	4-3
4.4	IOBUS MODEM .....	4-3
4.5	THERMOCOUPLE BURNOUT DETECTION .....	4-3
4.6	CALIBRATOR .....	4-4
4.7	VIM REDUNDANCY .....	4-4
4.8	VIM DIAGNOSTICS .....	4-4
<b>5.0</b>	<b>MODEL DESIGNATION .....</b>	<b>5-1</b>
5.1	ACCESSORIES .....	5-1
5.2	OPTIONS .....	5-2

---

---

## TABLE OF CONTENTS (continued)

<b><u>SECTION TITLE</u></b>	<b><u>PAGE</u></b>
<b>6.0 SPECIFICATIONS</b> .....	6-1
6.1 MODULE SPECIFICATIONS .....	6-1
6.2 ENVIRONMENTAL SPECIFICATIONS .....	6-2
6.3 ELECTRICAL CLASSIFICATION .....	6-3
6.3.1 Approvals (see important note) .....	6-3
6.3.2 CSA Hazardous Locations Precautions .....	6-4
6.3.2.1 Precautions - English .....	6-4
6.3.2.2 Précautions - Français .....	6-5
6.4 ELECTROMAGNETIC COMPATIBILITY (EMC) .....	6-5
<b>DECLARATION OF CONFORMITY</b>	
<b>WARRANTY</b>	

## LIST OF FIGURES

<b><u>FIGURE AND TITLE</u></b>	<b><u>PAGE</u></b>
FIGURE 1-1 APACS+ Voltage Input Module and Associated Hardware .....	1-2
FIGURE 1-2 Basic Input Wiring .....	1-3
FIGURE 2-1 VIM Termination Strip and Interconnect I/O Cable Mounting .....	2-7
FIGURE 2-2 VIM Marshalled Termination Assembly .....	2-9
FIGURE 2-3 Marshalling Utility Panel Dimensions .....	2-10
FIGURE 2-4 Mounting Marshalled Termination Assembly .....	2-12
FIGURE 2-5 VIM Marshalled Termination Assembly Mounting Ear Installation .....	2-13
FIGURE 2-6 Interconnect I/O Cable Keying .....	2-15
FIGURE 2-7 Module Keying Assignment and Installation .....	2-17
FIGURE 2-8 Using a Pin-type Crimp-on Connector .....	2-21
FIGURE 2-9 Typical Signal Input Connections .....	2-23
FIGURE 2-10 Signal Input Cable End Preparation .....	2-24
FIGURE 4-1 VIM Input Circuit Block Diagram .....	4-2
FIGURE 5-1 Model Designation .....	5-1



---

**LIST OF TABLES**

<b><u>TABLE AND TITLE</u></b>	<b><u>PAGE</u></b>
TABLE 1-1 TIC Contact Information .....	1-7
TABLE 1-2 ISO/IEC Symbols .....	1-8
TABLE 2-1 Voltage and Millivoltage Input Cable Selection .....	2-19
TABLE 2-2 Thermocouple and Extension Grade Wire Characteristics .....	2-20
TABLE 2-3 Termination Assembly Channel/Terminal Identification .....	2-22
TABLE 2-4 Unterminated I/O Cable Assembly .....	2-27
TABLE 3-1 LED Indications .....	3-2
TABLE 5-1 VIM Accessories .....	5-1
TABLE 5-2 VIM Options .....	5-2
TABLE 6-1 VIM Specifications .....	6-1
TABLE 6-2 VIM Environmental Specifications .....	6-2
TABLE 6-3 Agency Approvals .....	6-3

## 1.0 INTRODUCTION

This Instruction provides installation and service information for the following APACS+<sup>®</sup> components:

- Model VIMCCN Voltage Input Module (VIM) P/N 16171-126
- VIM Local Termination Strip P/N 16187-1
- VIM Marshalled Termination Assembly P/N 16170-1

This Instruction is divided into six major sections.

- Section 1, Introduction—Contains product description, product support, and lists related literature.
- Section 2, Installation—Describes environmental considerations and mechanical and electrical installation.
- Section 3, Maintenance—Consists of preventive maintenance, troubleshooting, assembly replacement procedures, and spare and replacement parts suggestions.
- Section 4, Circuit Description—Contains a brief system level description of the VIM.
- Section 5, Model Designation—Provides model designation and tables of accessories, attachments, and options.
- Section 6, Specifications—Consists of mechanical, electrical, and environmental specifications.

## 1.1 PRODUCT DESCRIPTION

The Voltage Input Module (VIM), which is shown in Figure 1-1, is an I/O element of the APACS+ Advanced Controller. It is an intelligent (microprocessor-based), configurable module, which interfaces thermocouple and voltage input signals with an APACS+ control module's IOBUS. Figure 1-2 illustrates basic input wiring.

The VIM:

- Minimizes hardware costs with 16 software-configurable channels (thermocouple or voltage input)
- Improves accuracy and simplifies configuration with integral linearization, autoranging, self-calibration, and cold junction compensation
- Facilitates faster response to field problems with a configurable burnout detection feature (up or down scale)
- Provides greater protection against short circuits via individually isolated channels
- Supports redundant architecture for high availability
- Reduces servicing time by allowing the module to be inserted or removed while powered without disturbing field wiring
- Isolates field faults by electrically isolating all input channels from the backplane and ground
- Complies with the European Union's Electromagnetic Compatibility (EMC) Directive, which requires process control equipment to be immune to electromagnetic interference (EMI) and limits the amount of electromagnetic emissions (see module specifications in Table 6-2 for more detailed information)

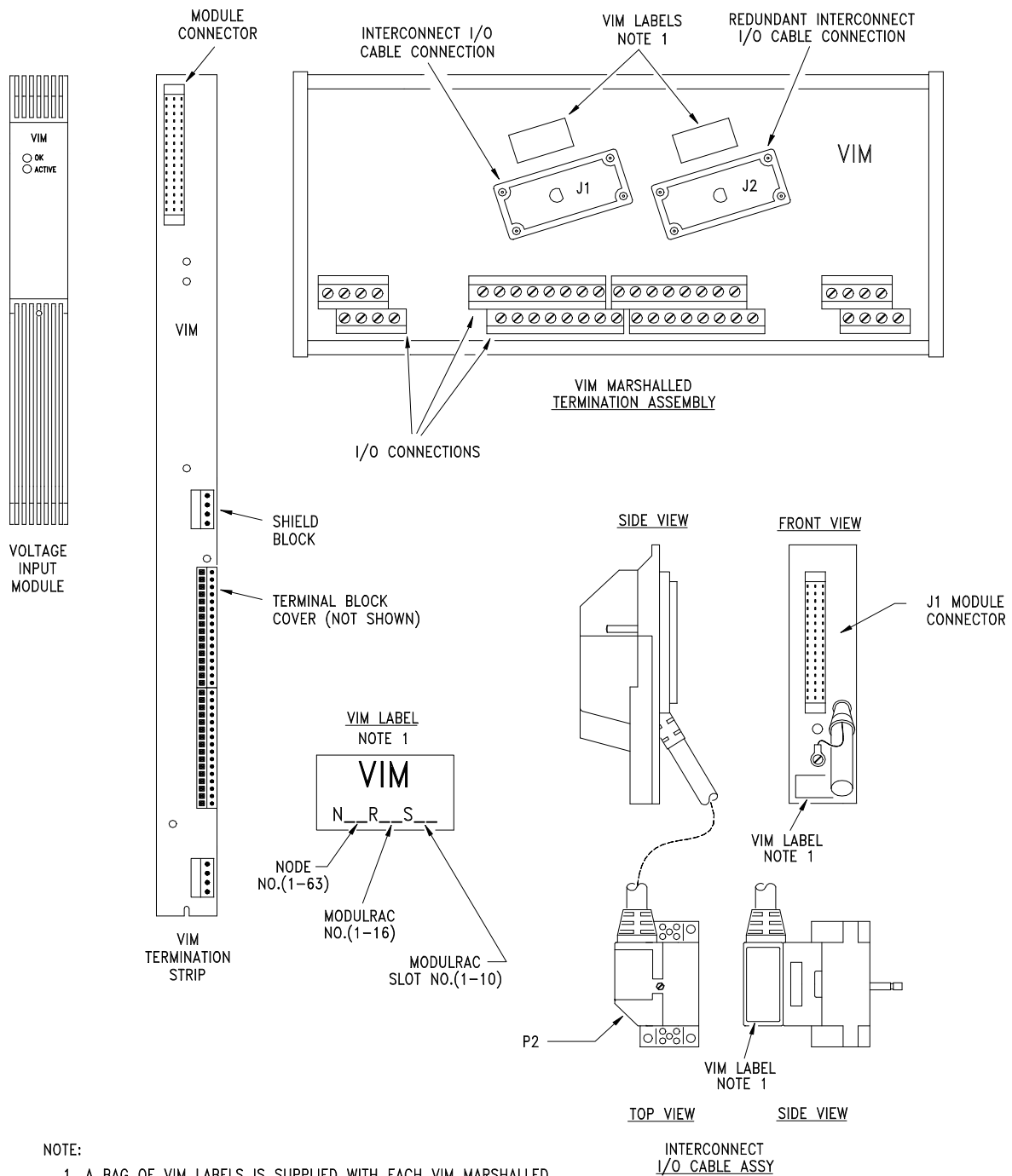

A02346A0

**FIGURE 1-1 APACS+ Voltage Input Module and Associated Hardware**

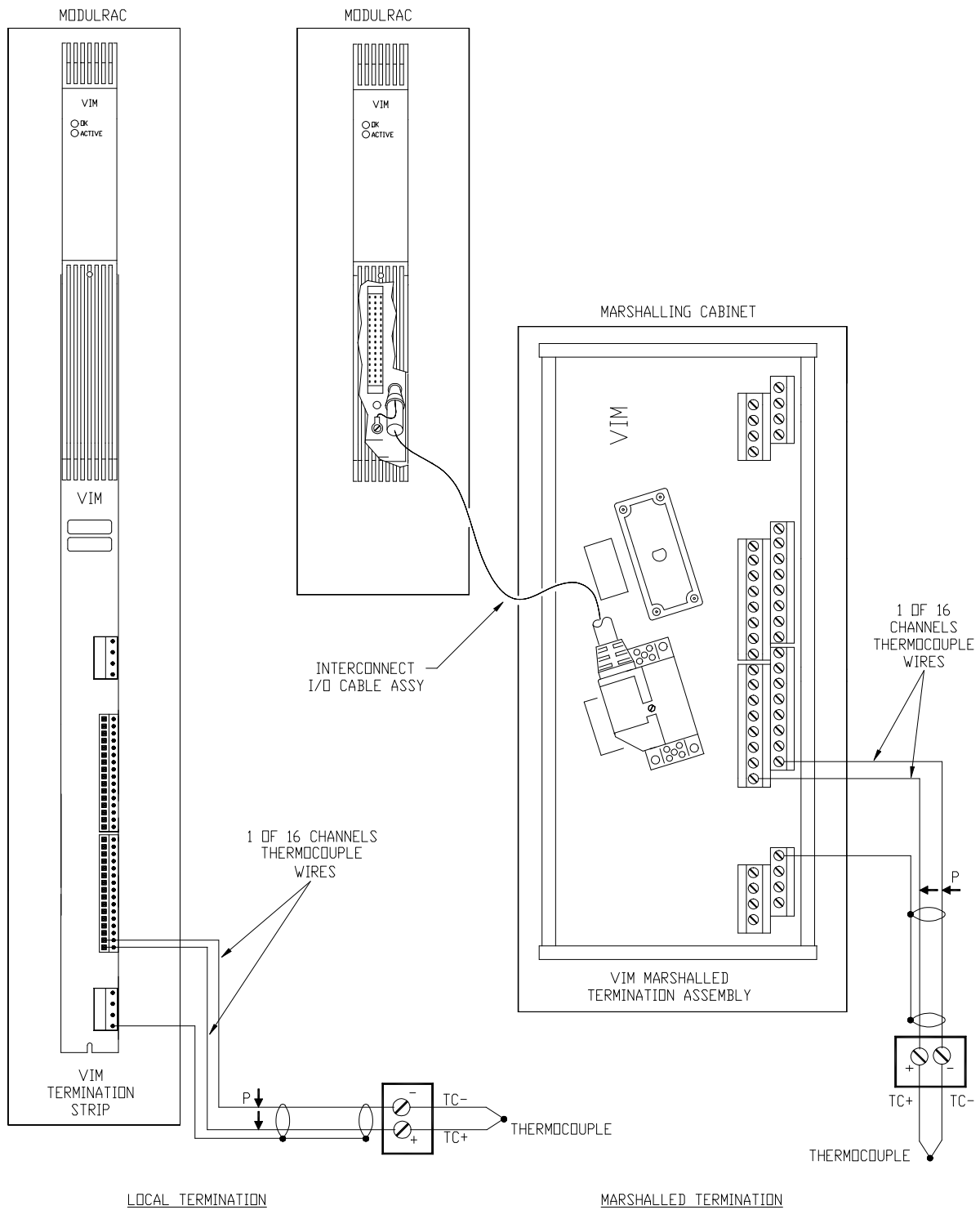

**FIGURE 1-2 Basic Input Wiring**

### 1.1.1 Channel Types

The VIM provides 16 channels, each of which can be configured to be a thermocouple or voltage input. Several standard features allow the VIM to accommodate many input types with minimal configuration and high accuracy, such as:

- Automatic linearization for thermocouple types J, K, E, T, R, S, B, N to user-selectable engineering units, such as °C, °F, °K, or °R
- Cold junction compensation provided for all thermocouple input measurements
- Autoranging input circuitry for thermocouple inputs, eliminating the need to specify a temperature range while maintaining high accuracy
- Self-calibration feature eliminating the need for field calibration
- Integral burnout detection to determine if a thermocouple has opened or, if, due to aging, its resistance has increased

In addition, the VIM's configurable channels reduce hardware costs and spare parts requirements by allowing one module to accommodate several input requirements.

### 1.1.2 Diagnostics

The VIM is designed to provide years of trouble-free service. However, in the event of unexpected operation, the VIM is equipped with extensive self-diagnostics. The goals of these diagnostics are to:

- Notify the appropriate personnel of a module malfunction or wiring error
- Perform automatic switchover in a fully redundant (1oo2D) APACS+ system

Any errors detected by these diagnostics are reported to the associated control module. The control module and the VIM maintain a log of current and historical errors that can be reviewed using the Diagnostic Logger Utility or the *4-mation*<sup>®</sup> configuration software. In addition, errors are indicated by the module's LED indicators.

There are two types of circuit diagnostics: those diagnostics that monitor overall module performance, which are common to all I/O modules, and those that cover individual input channels.

#### 1.1.2.1 Overall Module Performance Diagnostics

Diagnostics for overall module performance include failure detection in the communications, processor, and common circuits. These diagnostics include:

- Power supply diagnostics (monitor the three 24 Vdc power input busses for under voltage and the onboard isolated power supply for voltages within tolerance)
  - Over temperature diagnostics (check the module for over temperature conditions via an online monitor)
  - Memory diagnostics [run a complete IEEE published test on RAM memory at module startup, detect RAM failure modes in the optimal amount of time via galpat tests, and verify critical RAM data and ROM memory online with cyclical redundancy checking (CRC)]
-

- Communication diagnostics (verify IOBUS communications for each message via CRC)
- Redundancy diagnostics (monitor logic signals for valid combinations, compare redundancy status information from the IOBUS with logical signals on the module, reporting any discrepancies as errors)
- Watchdog timer diagnostics (detect processor operation failures via external and CPU hardware timers and monitor IOBUS and scanning operation via additional timers)
- CPU diagnostics (run manufacturer-supplied tests on CPU components, where results from the instruction sequences must match predetermined values)
- Software diagnostics (verify program flow control to ensure that software functions execute in proper sequence and time, perform data integrity checks, and compare data to predetermined ranges)
- Addressing diagnostics (compare module slot/rack addresses against their addresses at startup)

### 1.1.2.2 Input Circuit Diagnostics

Redundant isothermal sensors on the termination strip are compared to detect failures. To detect excessive drift failures, duplicate voltage references are also compared, while amplifiers and A/D converter circuits are continually automatically recalibrated online. Any component failures that require abnormal calibration correction are also detected. Input source impedance is monitored for up and down scale thermocouple burnout detection and fault detection for other components.

### 1.1.3 LED Indicators

The VIM's LEDs support local troubleshooting without an operator interface. The module includes two LEDs that indicate a combination of two of the following module statuses:

- Module OK
- Channel(s) faulted
- Module faulted
- Module unconfigured
- IOBUS communication failed
- Module failed
- Module active (calculate mode)
- Module inactive (verify mode)

### 1.1.4 Configuration

Like all APACS+ I/O modules, the VIM is configured using the *4-mation* software. The configuration is loaded into the module's memory, and a copy of the configuration is stored in the associated control module's non-volatile memory. This approach to configuration allows the module to be removed and replaced on-line without the need for reconfiguration.

During configuration, *4-mation* is used to assign a type to each channel (thermocouple input or voltage input) and several parameters which vary according to channel type.

### 1.1.4.1 Thermocouple Input Channel Parameters

- Thermocouple Type (J, K, E, T, R, S, B, or N)
- Engineering Units (°C, °F, °K, °R)
- Bias (in engineering units)
- Minimum and Maximum Scale
- Burnout (upscale, downscale, or no detection)
- Digital Filter Time Constant
- Step Response Time (defines the time for a moving average digital filter for the input signal, thus specifying the time to fully respond to an input step; this filter reduces periodic noise and improves repeatability and resolution)

### 1.1.4.2 Voltage Input Channel Parameters

- Input Range (1 to 5 Vdc, 0 to 5 Vdc, -10 to 10 Vdc, -5 to 5 Vdc, -1 to 1 Vdc, or custom range between -10 and 10 Vdc)
- Minimum and Maximum Scale
- Engineering Units
- Digital Filter Time Constant
- Step Response Time

### 1.1.5 Terminations

The VIM's field I/O can be terminated locally or remotely according to user needs and preferences. Local terminations reside directly below the VIM. Marshalled Termination Assemblies or Rail Termination Assemblies provide for terminations up to 100 feet (30.5 m) away from the VIM. Figure 1-2 is an example of the wiring used for any of these options.

## 1.2 PRODUCT SUPPORT

## Product Support

Our Technical Support Centers (TSC) offer a variety of technical support services that are designed to assist you with Siemens products and systems. Our support engineers have experience with troubleshooting, development, system startup, and system test. They will help you to solve your issues in an efficient and professional manner.

Customers in North America can contact Siemens Technical Support Center at 1-800-333-7421, on the web at: <http://support.automation.siemens.com>, or by e-mail: [techsupport.sea@siemens.com](mailto:techsupport.sea@siemens.com)

Customers outside North America can contact their local Siemens subsidiary; addresses and telephone numbers are listed on the Internet at the web site: <http://support.automation.siemens.com>.

When contacting Siemens, customers will be asked to provide site-contact information (name, address, and phone number), the product involved and detailed information regarding the nature of the issue.

Product documentation is now located in the Library forum of the Process Automation User Connection at: <http://sitiescape.sea.siemens.com/>. The Process Automation User Connection is a secure site. Registration is open to all verified users of Siemens process automation systems. If you are not already, and would like to become a member, please visit our Process Automation User Connection web page at: <http://www.sea.siemens.com/process/support/papauc.html>

Contained within the Process Automation User Connection is the APACS+/QUADLOG Secure Site at: <http://sitiescape.sea.siemens.com/forum/aca-1/dispatch.cgi/f.apacsquadlo> forum. This site is only open to customers with an active service agreement. It contains all service manuals, service memos, service notes, configuration manuals, etc. for the APACS+ and QUADLOG family of products. If you are experiencing technical difficulties with the site, please contact SiteScape technical support at: toll free 1-877-234-1122 (US) or 1-513-336-1474.



## A&D Technical Support

Worldwide, available 24 hours a day:





<b>United States:</b> Johnson City, TN	<b>Worldwide:</b> Nürnberg	<b>Asia / Australia:</b> Beijing
<p><b>Technical Support and Authorization</b>                      Local time: Monday to Friday                      8:00 AM to 5:00 PM                      Telephone: +1 (423) 262 2522                      or +1 (800) 333-7421 (USA only)                      Fax: +1 (423) 262 2289                      Mail to: <a href="mailto:techsupport.sea@siemens.com">techsupport.sea@siemens.com</a>                      GMT: -5:00</p>	<p><b>Technical Support</b>                      24 hours a day, 365 days a year                      Phone: +49 (180) 5050-222                      Fax: +49 (180) 5050-223                      E-Mail: <a href="mailto:ad.support@siemens.com">ad.support@siemens.com</a>                      GMT: +1:00</p> <p><b>Authorization</b>                      Local time: Monday to Friday                      8:00 AM to 5:00 PM                      Phone: +49 (180) 5050-222                      Fax: +49 (180) 5050-223                      Mail to: <a href="mailto:ad.support@siemens.com">ad.support@siemens.com</a>                      GMT: +1:00</p>	<p><b>Technical Support and Authorization</b>                      Local time: Monday to Friday                      8:00 AM to 5:00 PM                      Phone: +86 10 64 75 75 75                      Fax: +86 10 64 74 74 74                      Mail to: <a href="mailto:ad.support.asia@siemens.com">ad.support.asia@siemens.com</a>                      GMT: +8:00</p>
<p>Automation and Drives Service and Support International  <a href="http://www.siemens.com/automation/service&amp;support">http://www.siemens.com/automation/service&amp;support</a></p>		
<p>The languages of the SIMATIC Hotlines and the authorization hotline are generally German and English.</p>		

<b>TIC EUROPE</b>	Tel:	See previous table for updated information.
	Fax:	
	E-mail:	
	Hours of Operation:	
	Secure Web Site:	

### 1.3 INTERNATIONAL STANDARDS ORGANIZATION (ISO) SYMBOLS

Refer to Table 1-2 for an explanation of ISO and IEC symbols that, when appropriate, are prominently displayed on the surfaces of hardware. The symbols are also used in instructions to denote **CAUTION** and **WARNING** notes.

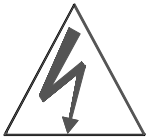
**TABLE 1-2 ISO/IEC Symbols**

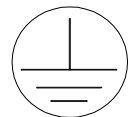
SYMBOL	PUBLICATION	DESCRIPTION
 Background Color = Yellow Symbol Color = Black Outline Color = Black	ISO 3864, No. B.3.6	<b>WARNING: Risk of Electric Shock.</b> The symbol is prominently displayed on the surfaces of hardware. When used in an instruction, text accompanies the symbol which identifies something that can be dangerous and possibly life threatening to personnel. For example: <b>WARNING: Risk of electric shock. Remove power from all involved wires before making connections to the Marshall Termination Assembly.</b>
 Background Color = Yellow Symbol Color = Black Outline Color = Black	ISO 3864, No. B.3.1	<b>CAUTION:</b> Refer to accompanying Installation and Service Instruction. The symbol is prominently displayed on the surfaces of hardware. When used in an instruction, text accompanies the symbol which identifies something that can damage equipment or cause a control problem with a process. For example: <b>CAUTION: The safety system should not be operated with forced I/O.</b>
 Background Color = White Symbol Color = Black Outline Color = Black	IEC 417, No. 5019	<b>PROTECTIVE CONDUCTOR TERMINAL</b> Symbol is prominently displayed on the surfaces of hardware.

## 1.4 RELATED LITERATURE

The following literature should be available when performing the VIM installation.

- *APACS+ MODULRAC Installation and Service Instruction (SD39MODULRAC-1)*
  - *APACS+ SIXRAC Installation and Service Instruction (SD39SIXRAC-1)*
  - *APACS+ UNIRAC Installation and Service Instruction (SD39UNIRAC-1)*
  - *APACS MODULPAC 1000 Installation and Service Instruction (SD39MODULPAC-1)*
  - *APACS MODULPAC 2000 Installation and Service Instruction (SD39MODULPAC-2)*
  - *APACS Relay Marshalled Termination Assembly Installation and Service Instruction (SD39RMTA-1)*
-

## 2.0 INSTALLATION

This section describes installation of the VIM and its associated assemblies. Be sure to review and complete the steps in section 2.2 before proceeding with the VIM installation.

### IMPORTANT

The VIM installation should be in accordance with the National Electrical Code (NEC) and other applicable construction and electrical codes.

## 2.1 HARDWARE IDENTIFICATION

### 2.1.1 Voltage Input Module (VIM)

The Voltage Input Module is identified by the letters “VIM” on the bezel and by two nameplate labels: a large label, shown below, located on the tracking plate (left side of VIM in Figure 1-1), and a small label inside the bezel compartment. Both labels contain the module’s model designation, part number/issue level, ROM version number or software compatibility identification, and serial number. The larger label also lists the current and voltage requirements of the module, and space is provided for additional information, such as agency certifications.

MODEL VIM <sub>xx</sub> N	AMPS 0.14 A	P/N 16171-121
ROM VERSION <sub>xx.x</sub>	VOLTS 24 VDC	S/N xxxxxxxx

### 2.1.2 VIM Local Termination Strip Identification

The VIM Local Termination Strip is identified by the following information printed on its surface:

VIM  
VOLTAGE INPUT  
MODULE  
MOORE PRODUCTS CO.  
TERMINATION STRIP  
PN 16187-1

### 2.1.3 VIM Marshalled Termination Assembly Identification

The VIM Marshalled Termination Assembly is identified by the following information printed on its surface:

VIM  
VOLTAGE INPUT  
MODULE  
MOORE PRODUCTS CO.  
MARSHALLED TERMINATION  
ASSEMBLY  
PN 16170-1

## 2.2 CONSIDERATIONS AND PREPARATION - See Danger Alert on the last page

Read sections 2.2.1 and 2.2.2 before continuing with the VIM installation. Section 2.2.1 describes considerations required to ensure that the modules are compliant with the European Union's Electromagnetic Compatibility (EMC) Directive.

### 2.2.1 EMC Directive Installation Considerations

Some installations of VIM modules may require adherence to the European Union's Electromagnetic Compatibility (EMC) Directive. Refer to the "Declaration of Conformity" statement at the back of this document that lists the certificate number of the Technical Construction File issued to the Voltage Input Modules. Compliance with the Directive requires some or all of the following:

- APACS+ systems must use enclosures having sufficient RF attenuation.
- AC power input conductors to the enclosure must be filtered.
- MODULBUS (M-BUS) cables that enter or exit the enclosure must be filtered.
- The "shield" of all shielded cables that exit the enclosure must be connected to the enclosure.

Consult the factory for additional information concerning EMC Directive installation and the availability of enclosures and needed hardware.

### 2.2.2 Preparations

1. Install the MODULRAC, SIXRAC, or UNIRAC and the Local Termination Panel (for local termination only) in the cabinet where VIMs are to be installed. VIMs should not be installed in the rack at this time, however, the rack address (1 TO 16) and rack slot numbers (1 to 10) for VIM installation should be known.
2. If local I/O termination is employed, tag all I/O cables and route them into the cabinet. They should be ready for cable end preparation and connection to the VIM Termination Strips. Cable wire sizes: 14 to 26 AWG (American Wire Gage).

3. If remote I/O termination is employed, complete the following:
  - 1) If Marshalling Utility Panels are being used, install them in their respective marshalling cabinets.
  - 2) Tag all I/O cables and route them into the marshalling cabinet. They should be ready for cable end preparation and connection to the VIM Marshalled Termination Assemblies (cable wire sizes: 10 to 26 AWG) or user supplied termination assemblies. User supplied termination assemblies require a VIM Temperature Transducer Kit and an unterminated Interconnect I/O Cable. The VIM Temperature Transducer Kit is listed under "Accessories" in section 5.2 of this Instruction.
  - 3) Route the Interconnect I/O Cable (or Unterminated I/O Cable) between the marshalling cabinet and the cabinet and rack in which the VIM will be installed. Refer to Figure 1-1; J1 will be installed in the rack and P2 will connect to the VIM Marshalled Termination Assembly in the marshalling cabinet.
  - 4) If an Unterminated I/O Cable is installed, user-supplied terminations (e.g. terminal blocks) must be installed for field signal input wiring and the I/O Cable.
4. A dedicated, reliable, electrically clean power source should be furnished by the user to power field devices providing voltage input signals. An uninterruptible power supply (UPS) can be installed for increased reliability and power quality.

VIM input channels are isolated from one another, thus permitting voltage inputs to each channel to originate from dedicated, separate power sources.

High-power EMI-producing equipment should not be connected to any power lines dedicated to VIM input signals. See inserted Page 2-3a

## 2.3 ENVIRONMENTAL CONSIDERATIONS

- Many industrial environments create severe operating conditions. The conditions at each VIM location must be within the specifications stated in section 6.2.



Exceeding the specified operating temperature limits can adversely affect performance and may cause damage. Air temperature should be periodically checked to ensure that this specification is not being exceeded.

- To ensure operator safety, VIM Marshalled Termination Assemblies shall be installed in enclosures which require a key or special tool to gain access to the equipment.

Change Since Revision 1

Add to Section 2.2.2 item 4.

**WARNING!**

Arc welding to surfaces with attached, active thermocouples can damage VIM termination transducers. Remove VIM from rack or disconnect I/O wiring from VIM termination before welding.

- To ensure reliable data communications, it would be prudent to locate APACS+ equipment as far as possible from sources of interference such as high current electrical equipment which emit strong electromagnetic fields and switching transients.

## **2.4 EQUIPMENT DELIVERY AND HANDLING**

The following subsections provide information of interest to shipping, receiving, and warehouse personnel.

### **2.4.1 Predelivery Test**

An VIM is fully tested and inspected to ensure proper operation. If the VIM is ordered factory installed in a MODULPAC or other enclosure, the VIM is tested as part of the overall APACS+ process automation system and inspected to ensure proper operation.

### **2.4.2 Factory Shipment**

VIMs to be installed by the user are placed in static shielding bags and packaged for shipment. Accessories are packaged separately. If the VIM is ordered factory installed in a MODULPAC or other enclosure, the enclosure is bolted to a pallet and wrapped for protection during shipment.

### **2.4.3 Receipt of Shipment**

All cartons should be inspected at the time of their delivery for possible external damage. Any visible damage should be immediately recorded on the carrier's copy of the delivery slip.

Each carton should be carefully unpacked and its contents checked against the enclosed packing list. At the same time, each item should be inspected for hidden damage that may or may not have been accompanied by exterior carton damage.

If it is found that some items have been damaged or are missing, refer to sections 2.4.4 or 2.4.5 and notify Moore immediately, providing full details. In addition, damages must be reported to the carrier with a request for their on-site inspection of the damaged item and its shipping carton.

### **2.4.4 Equipment Handling**

The VIM is completely enclosed and may be safely handled without undertaking special ESD (electrostatic discharge) handling procedures provided the bezel compartment door is closed and secured. **DO NOT** touch the connector pins on the back of the module.





Use a grounded wrist strap to provide ESD protection whenever the module's bezel door is opened.

### 2.4.5 Equipment Storage

The storage temperature and humidity parameters of section 6 must be met for storage of an VIM.

## 2.5 VIM TERMINATION STRIP INSTALLATION

Install a VIM Termination Strip at the rack slot location of each VIM when local I/O termination is employed. As shown in Figure 2-1, a Local Termination Panel must be installed.

### NOTE

On the Termination Strip, delicate temperature sensors U1/U2 are mounted at each end of the terminal block. Handle the Termination Strip carefully to avoid sensor damage.

Refer to Figure 2-1 and the following mounting instructions:

1. Consult user's or system integrator's rack documentation and note the slot locations assigned to each VIM in each rack.
2. Note the following on a rack or a Termination Strip:
  - On a rack, locate and identify the extruded spacer to which the lower edge of the backplane is mounted. Note that the bottom of the extruded spacer is grooved. The top edge of a Termination Strip will rest in this groove.
  - Identify a series of alignment pins located below the rack frame that span the width of the rack panel. One of these pins will engage a hole located on the Termination Strip above the MOORE logo. The left-most pin corresponds to rack slot #1.
  - The Termination Strip's captive mounting screws can be seen projecting from the bottom of the plastic extrusion panel.

3. Mount each Termination Strip at its assigned location as follows:
  - 1) Angle the top edge of the Termination Strip toward the backplane's extruded spacer and insert the tip of the Termination Strip in the spacer's groove.
  - 2) Slide the Termination Strip in the groove until it is vertically and horizontally aligned with the appropriate pin (slot #).
  - 3) Carefully lower the Termination Strip and engage the pin with the extrusion and board pin mounting hole. Firmly push down to seat the strip on the pin. When the strip is properly seated, the pin will be flush with, or project slightly above the top surface of the strip.
  - 4) Secure the Termination Strip to the rack and Local Termination Panels with the strip's captive mounting screws, which are automatically aligned with their respective panel mounting holes.

#### **NOTE**

Do not remove any terminal block covers on the VIM Termination Strips. The purpose of these covers is to prevent temperature shifts due to air drafts at the terminals.

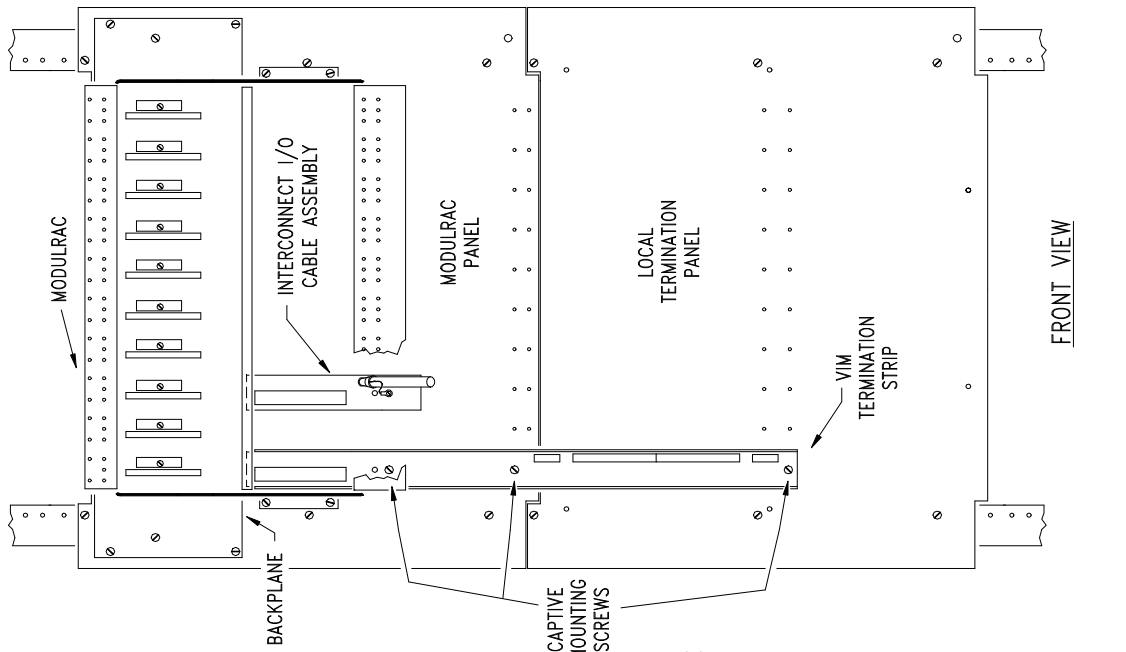

A0234710

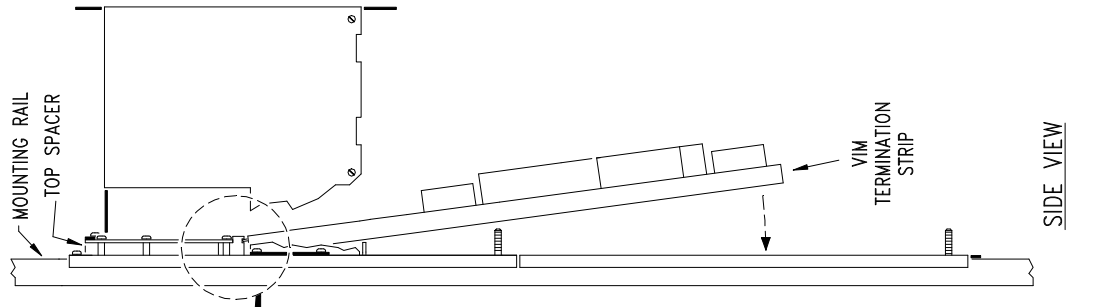
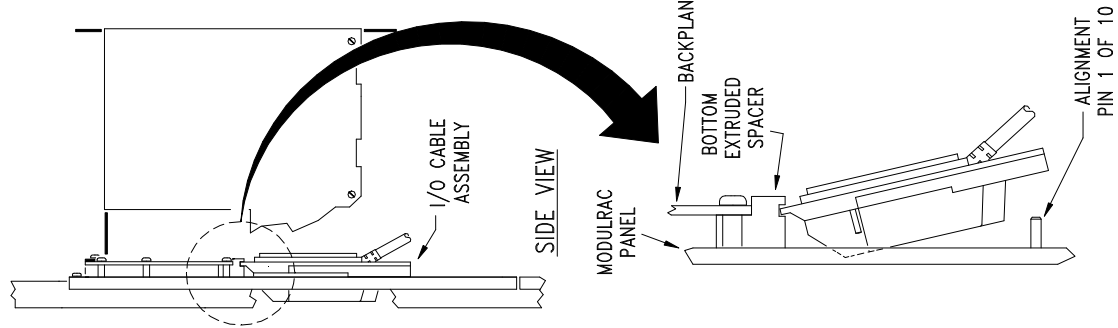

**FIGURE 2-1 VIM Termination Strip and Interconnect I/O Cable Mounting**

---

## 2.6 VIM MARSHALLED TERMINATION ASSEMBLY AND CABLE INSTALLATION

Section 2.6.1 describes installing the VIM Marshalled Termination Assembly to a DIN rail. Section 2.6.2 describes installing the VIM Marshalled Termination Assembly to a flat surface. Section 2.6.3 describes connecting the VIM Interconnect I/O Cable Assembly.

### 2.6.1 Marshalled Termination Assembly Installation

The VIM Marshalled Termination Assembly snaps onto a user-supplied DIN rail of the following type:

- Preferred: Top hat profile EN 50 022-35mm X 7.5mm or EN 50 022- 35mm X 15mm
- Alternate: G-profile EN 50 035-G 32mm

Refer to the following to mount a VIM Marshalled Termination Assembly to a blank Utility Panel or a Marshalling Utility Panel:

1. If a P/N 16114-12 blank Utility Panel or a user fabricated panel is being used, mount user-supplied DIN rails and wire duct. A Utility Panel can be mounted in a MODULPAC marshalling cabinet. A user fabricated panel is typically mounted in a cabinet provided by the user. Refer to Figures 2-2 and 2-3 for Marshalled Termination Assembly and Utility Panel dimensions.
  - 1) Determine the mounting layout for DIN rails, wire ducts and Marshalled Termination Assemblies.

#### NOTE

Marshalled Termination Assembly dimensions can vary with type. Refer to the Installation And Service Instruction for each I/O type to be installed.

- 2) Drill and tap DIN rail and wire duct mounting holes in the panel. If applicable, refer to Instruction SD39MODULPAC-1 for removal of the Utility Panel.
2. Retrieve the VIM Marshalled Termination Assembly to be mounted including a supplied bag of VIM labels (P/N 14205-679) and Cable Keying Kit (P/N 16056-435). Temporarily set aside the Cable Keying Kit.

#### NOTE

On the Marshalled Termination Assembly, delicate temperature sensors U1/U2 are mounted at each end of the terminal block. Handle the Assembly carefully to avoid sensor damage.

- 1) Consult user's or system integrator's documentation and note the rack address number (1 to 16) and slot number assigned to the VIM, and, if applicable, the redundant VIM that will be connected to this VIM Marshalled Termination Assembly. For rack-to-rack redundant VIMs connected to a MODULNET, the MODULNET node address (1-63) must also be noted for each rack.

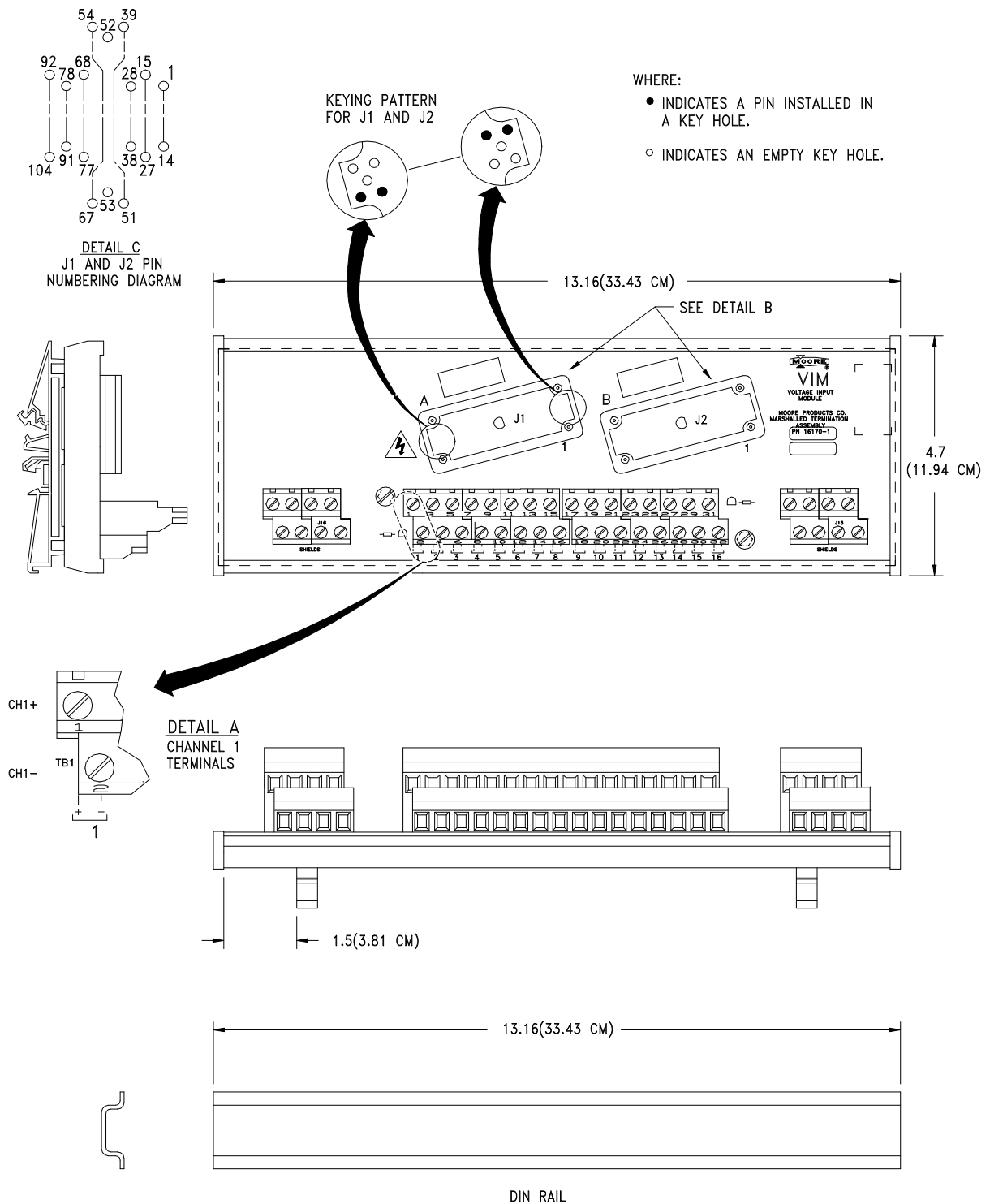

DIMENSIONS IN INCHES,  
UNLESS OTHERWISE SPECIFIED.

A0234810

**FIGURE 2-2 VIM Marshalled Termination Assembly**

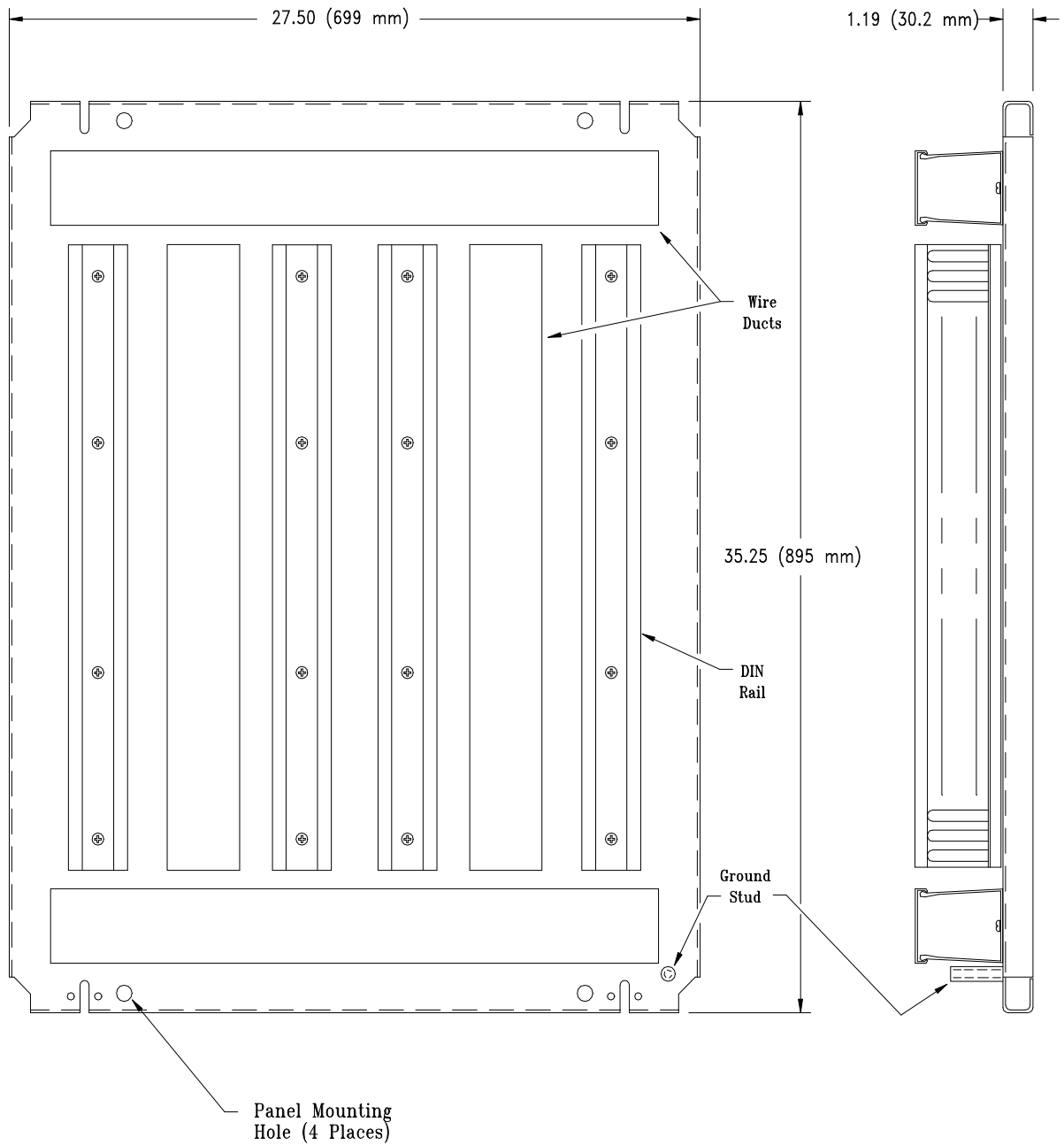

Notes:

1. Dimensions are in inches (millimeters).
2. Marshalling utility panel is shown and includes DIN rails and wire ducts.
3. Utility panel is a bare panel.

A0228510

**FIGURE 2-3 Marshalling Utility Panel Dimensions**

- 2) Retrieve a VIM label and record the node, rack, and slot numbers on the label (see Figure 1-1). If redundancy is applicable, record the appropriate numbers on a second VIM label. Save the remaining labels for use in section 2.6.3, step 3.
3. Refer to Figure 1-1 and attach the VIM label adjacent to connector J1. If applicable, attach the redundant VIM label adjacent to J2.
4. Ensure that J1 and J2 are factory keyed according to the pattern shown in Figure 2-2, detail B.

#### **NOTE**

The user then keys the connector on the mating Interconnect I/O Cable as described in section 2.6.3. This will prevent connection to the VIM Termination Assembly of an Interconnect I/O Cable from another type of I/O module (e.g. CDM or SAM).

5. Refer to Figure 2-4 for the procedure to mount the VIM Marshalled Termination Assembly to a DIN rail.

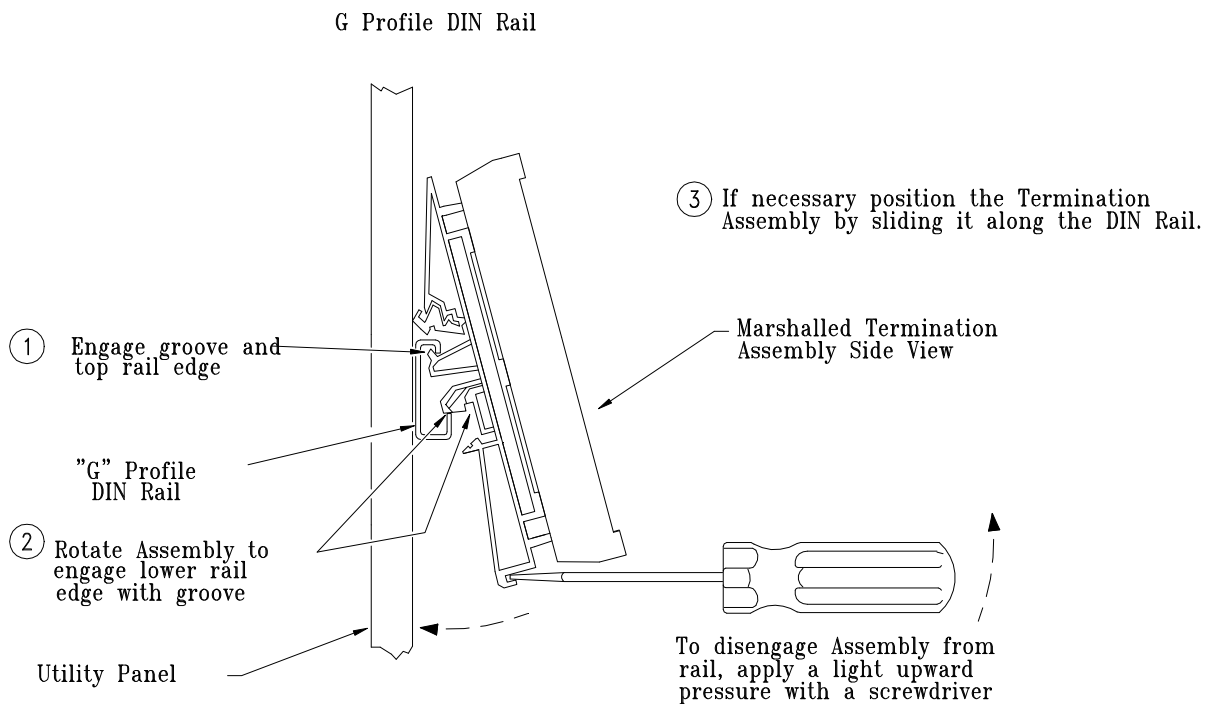
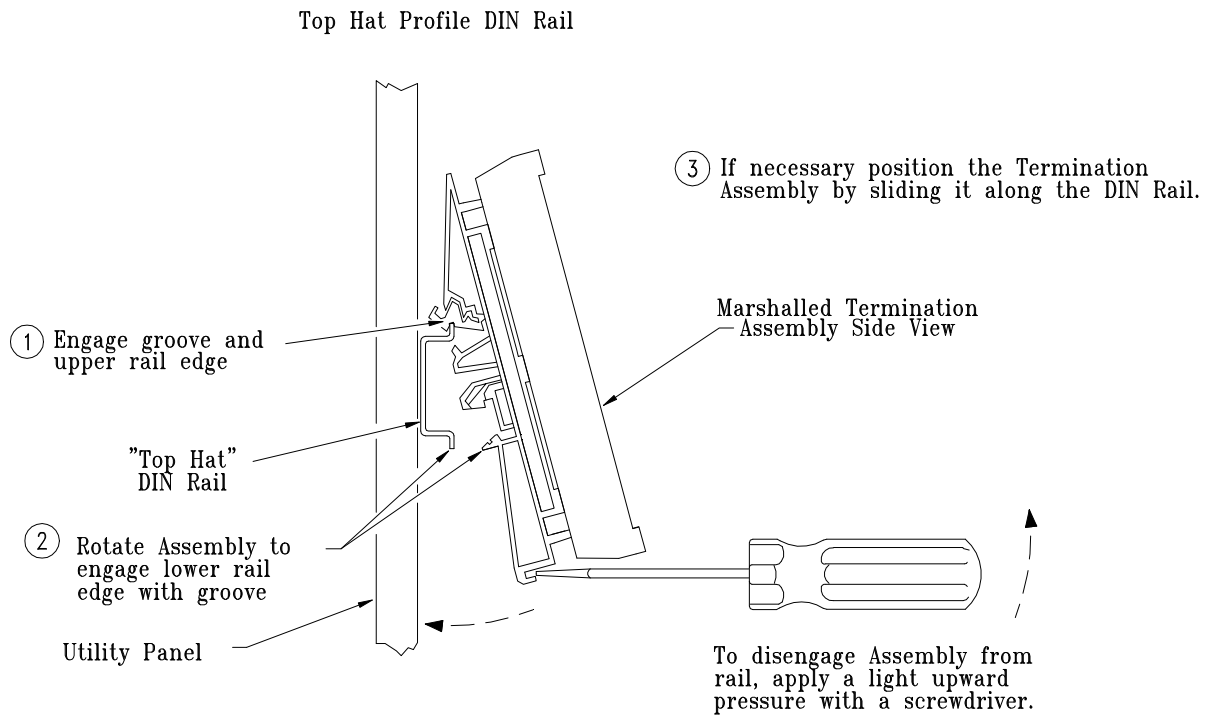

**FIGURE 2-4 Mounting Marshalled Termination Assembly**



## 2.6.2 Optional (Flat Surface) Marshalled Termination Assembly Installation

The removal of the DIN rail mounting feet from the Marshalled Termination Assembly (MTA), in conjunction with the installation of four Mounting Ears, permits the MTA to be flat-mounted to a panel. Four P/N 16056-562 (single piece) Mounting Ears are required per MTA (see Table 5-2).

Refer to Figure 2-5 and the following installation procedure:

1. At one end of the Marshalled Termination Assembly, remove the three end cap securing screws from the card holder end cap. Remove and set aside the end cap.
2. Slide the DIN rail mounting feet from the grooves in the bottom of the Marshalled Termination Assembly card holder. Discard the mounting feet. Re-install the just removed end cap.
3. Retrieve four mounting Ears and insert them in the appropriate mounting holes provided in the end caps as illustrated in Figure 2-5.
4. Use the MTA as a template to mark the location of the mounting ear holes on the surface of the panel. Typical mounting screw size is M4, or users can select another size. After drilling or punching the holes, the holes should be threaded. Refer to Figure 2-2 for MTA dimensions.

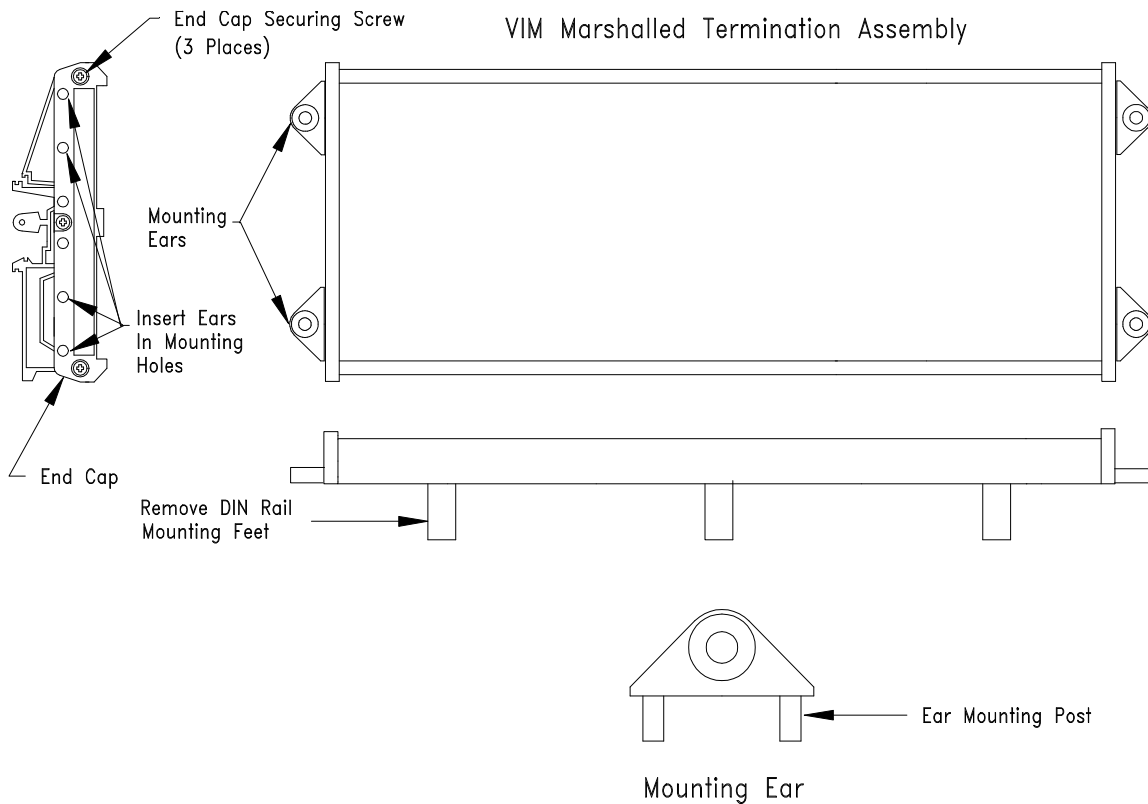

**FIGURE 2-5 VIM Marshalled Termination Assembly Mounting Ear Installation**

### 2.6.3 Interconnect I/O Cable Installation

An Interconnect I/O Cable (Figure 2-6) is used to connect each VIM to a VIM Marshalled Termination Assembly when remote I/O termination is employed. The cable-to-module connector (J1) is installed at the rack slot location of a VIM. It is assumed that as part of the site preparation procedure all tagged Interconnect I/O Cables have been routed and pulled into their respective cabinets and are ready for connection. An Unterminated I/O Cable is installed similarly at the rack, however, terminations in the marshalling cabinet are user-supplied .

VIM Marshalled Termination Assemblies should already be installed in the marshalling cabinet (see section 2.6.1) and be ready for cable connection. Refer to Figures 2-1 and 2-6 and the following procedure:

1. Note the following on the cable's molded J1 connector.
  - The lower face area of J1 has a "pin mounting hole" located above a captive mounting screw. This hole engages one of the rack panel's alignment pins.
  - The top edge of J1 will rest in the groove of the backplane's extruded spacer as illustrated by a detail in Figure 2-1.
2. Consult user's or system integrator's documentation and note the MODULNET node address (if applicable), rack address number (1-16), and slot number assigned to the VIM. J1 will be installed at this location.
3. Install J1 at its assigned location as follows:
  - 1) Angle the top edge of the molded connector toward the backplane's extruded spacer and insert its tip in the spacer's groove.
  - 2) Slide the connector in the groove until it is vertically and horizontally aligned with the appropriate pin (slot #).
  - 3) Carefully lower the molded connector and engage the alignment pin with the connector's pin mounting hole. Firmly push down to seat the connector on the pin. When the connector is properly seated, the pin will be flush with or project slightly above the face of the connector.
  - 4) Secure the connector to the rack panel with its captive mounting screw which is automatically aligned with its panel mounting hole.
  - 5) Get two labels from the bag of VIM labels. Record on each label the appropriate numbers noted in the above step 2 (Figure 1-1). Attach one label each to the molded J1 and the P2 connectors.
4. Key cable connector P2.

Get the P/N 16056-435 Cable Keying Kit set aside in step 2 of section 2.6.1. The kit contains keying pins and an instruction. Refer to Figure 2-6 for the assigned keying pattern and install the pins as described in the supplied instruction.

---

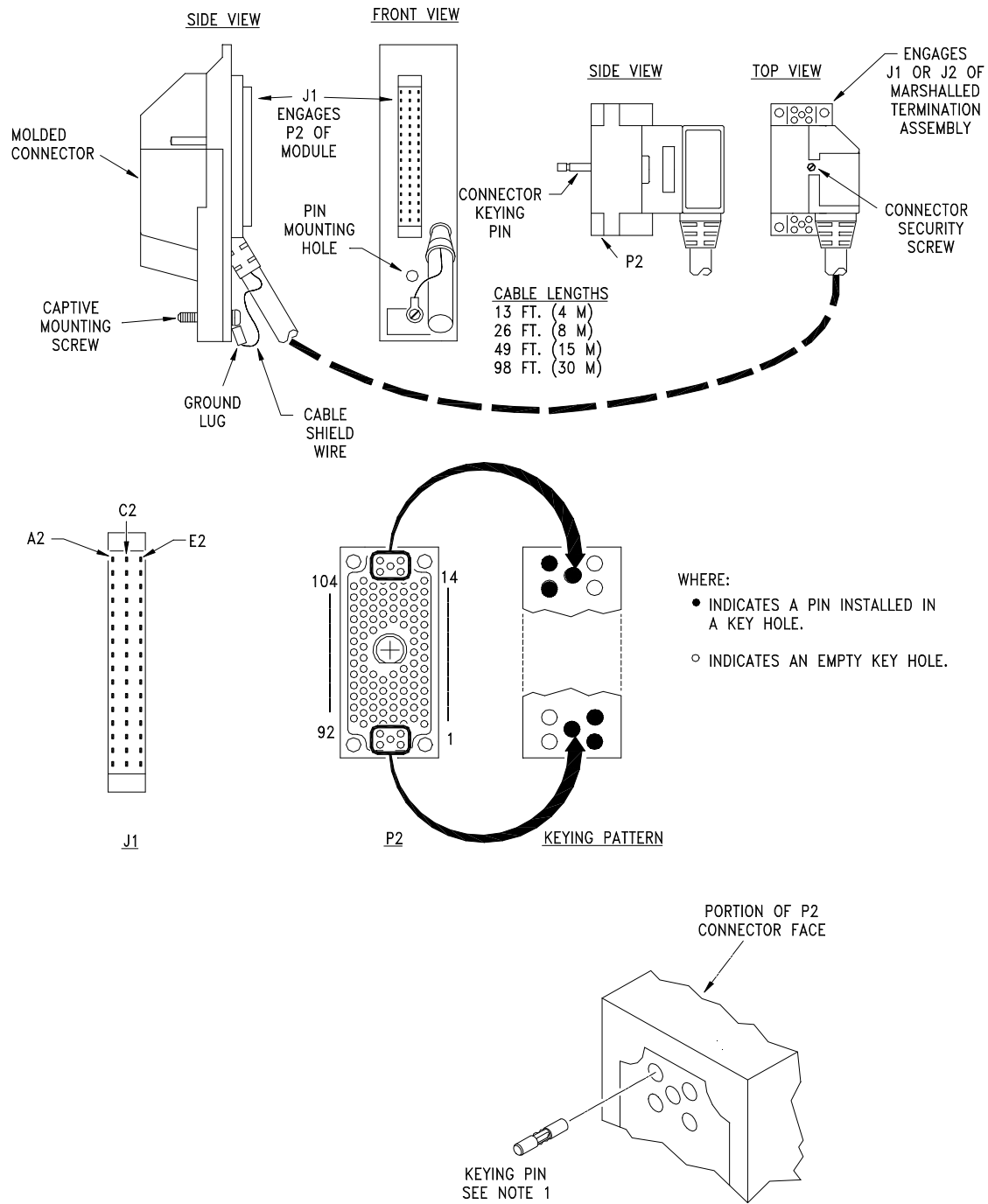

- NOTES:
- KEYING PINS ARE PRESSED INTO EACH GROUP OF 5 HOLES AT THE TOP AND BOTTOM OF P2 AS SHOWN IN THE ABOVE KEYING PATTERN.

A02218A0

**FIGURE 2-6 Interconnect I/O Cable Keying**

5. Connect the free end of the I/O Cable Assembly to its respective I/O termination assembly. Perform either of the following, depending upon cable type:

1) Interconnect I/O Cable Assembly (P2 installed)

- a) Connect cable connector P2 (Figure 2-6) to the “A” (J1) connector on the Marshalled Termination Assembly (Figure 1-1). A keying pin projecting from the face of P2 ensures correct mating.
- b) Press P2 firmly onto J1. Torque the securing screw on the top of P2’s connector shell to 50 inch-pounds maximum.

OR

2) Unterminated I/O Cable Assembly (P2 not installed)

Refer to Table 2-4 for color code and function of each unterminated wire. Refer to user wiring diagrams to make the proper cable connections to the termination assembly.

6. On redundant VIMs only, connect the redundant I/O Cable as described in step 5 above.

## 2.7 VIM INSTALLATION

Modules are shipped individually packaged in protective, sealed, static shielding bags. Refer to section 2.4.4 for module handling considerations. Section 2.7.1 describes keying a rack slot. Section 2.7.2 describes installing the module in the rack.

Each rack slot and each module must be keyed to prevent accidental installation of a module into an incompatible slot which may impair system performance. *Keying is highly recommended*; see Figure 2-7.

- Modules are keyed at the factory. The keying pattern is unique to each module type (e.g. ACM, CCM, CDM). See Figure 2-7 for the VIM keying pattern.
- A factory assembled rack is keyed at the factory. A user-assembled rack is keyed by the user according to the module type assigned to each slot. This keying pattern complements the module’s keying pattern. Stop plugs are supplied with the rack.
- When adding a module to a rack, be sure to key the rack slot.

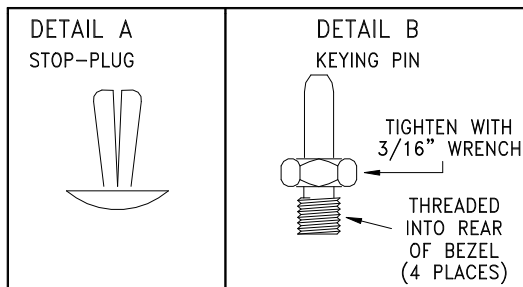
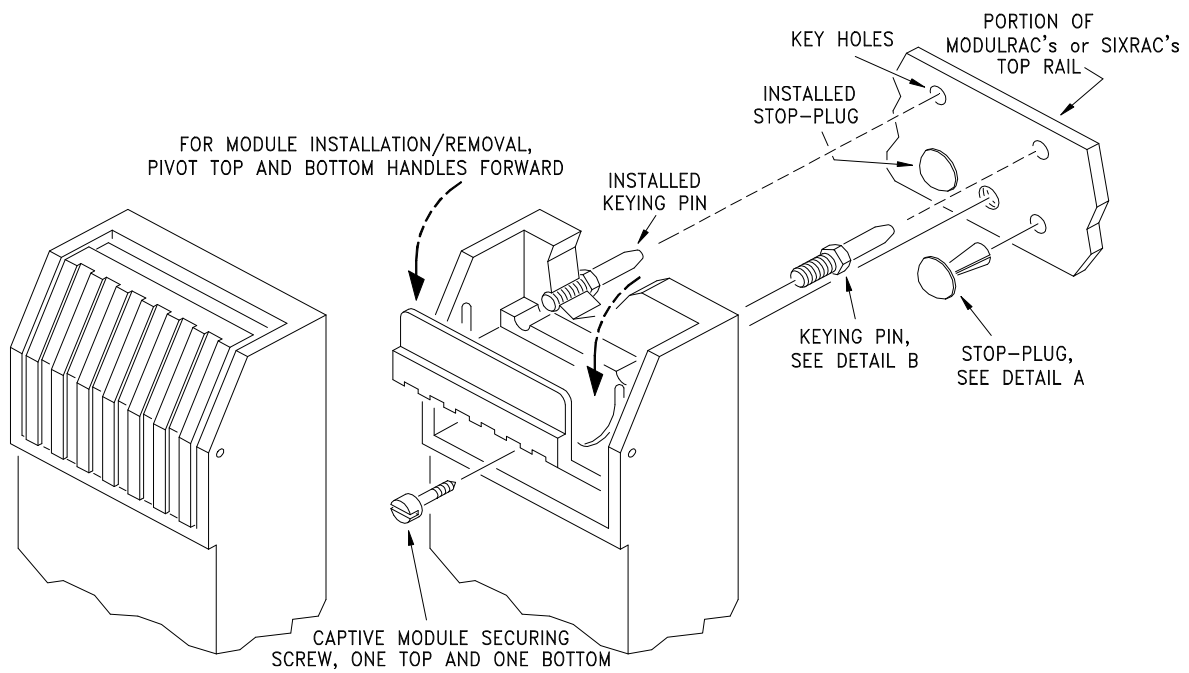

**NOTES:**

1. KEYING PINS ARE THREADED INTO 4 OF THE 8 HOLES IN THE REAR TOP AND BOTTOM SECTIONS OF THE MODULE'S BEZEL.
2. PLASTIC STOP-PLUGS ARE PRESSED INTO TOP AND BOTTOM RAIL HOLES AT A PARTICULAR SLOT TO MATCH A KEYPED MODULE TO A SLOT.

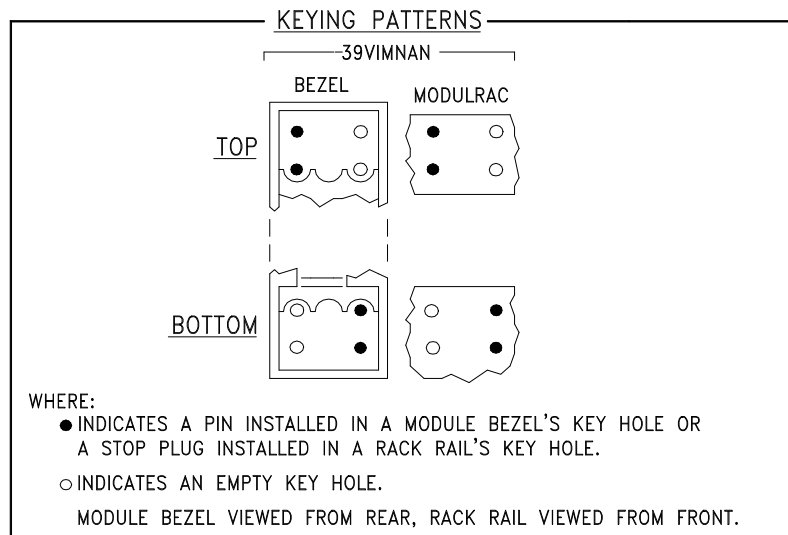

A02350A0

**FIGURE 2-7 Module Keying Assignment and Installation**

### 2.7.1 Module and Module Rack Mechanical Keying

**To key a VIM module that was not keyed at the factory:**

1. Order Keying Kit P/N 16056-166. The kit contains module keying pins and module rack stop plugs.
2. Refer to Figure 2-7 and note the bezel keying pattern that is applicable to the associated VIM.
3. Thread the keying pins into the holes in the back of the module's bezel identified by the solid dots and carefully tighten the pins.

**To key a module rack:**

1. Get the Keying Kit supplied with the rack (or the Keying Kit in step 1 above).
2. Refer to Figure 2-7 and note the rack keying pattern applicable to the associated VIM . Also, locate the rack top and bottom rails.
3. Press the stop plugs into the holes identified by the solid dots.

### 2.7.2 Module Installation

**To install a module:** (Refer to Figure 2-7):

1. Refer to user documentation and note the assigned rack slot number.
2. Remove the VIM from its static shielding bag and insert the module in the assigned slot. Firmly seat the module in the backplane and lower connectors. A properly seated module will have the rear of its bezel flush against the rack's front rails.

A keyed module that is not keyed to that slot will not engage the backplane and lower connectors or seat flush against the rack's front rails.

3. Pull open the bezel's pivoting top and bottom handles to expose the module's slotted captive mounting screws and secure the module to the rack. Close the bezel's handles when finished.

#### **IMPORTANT**

Do not use the captive mounting screws to seat the module.  
Damage to the bezel can result.

## 2.8 ELECTRICAL INSTALLATION

This section describes field signal input connections to a locally mounted VIM Termination Strip and to a remote mounted VIM Marshalled Termination Assembly. It is assumed that tagged field I/O wires have been pulled into the cabinet and are ready for preparation and connection.

### 2.8.1 Field Input Wire Selection

A VIM Termination Strip and a VIM Marshalled Termination Assembly provide for connection of up to 16 pairs of configurable voltage, millivoltage, or thermocouple inputs. For voltage and millivoltage type inputs, the recommended cables are given in Table 2-1.

**TABLE 2-1 Voltage and Millivoltage Input Cable Selection**

TERMINATION	WIRE SIZE
Local VIM Termination Strip	Twisted pairs of 28 to 14 AWG stranded or solid single conductor per terminal. Max. wire size of two conductors per terminal = 16 AWG. Shielded twisted pairs are recommended.
VIM Marshalled Termination Assembly	Twisted pairs of 26 to 10 AWG stranded or solid single conductor per terminal. Max. wire size of two conductors per terminal = 12 AWG. Shielded twisted pairs are recommended.

Thermocouple leads are usually color coded. Standard ANSI color coding is used on insulated thermocouple or extension grade wire when the insulation permits. A colored tracer to indicate lead polarity may be used. Refer to Table 2-2 for color code information and bare wire characteristics for identifying non-color coded wires.

**TABLE 2-2 Thermocouple And Extension Grade Wire Characteristics**

ANSI TYPE T/C	POSITIVE LEAD		NEGATIVE LEAD		BARE WIRE CHARACTERISTICS
	METAL	COLOR	METAL	COLOR	
T	Copper	Blue	Constantan	Red	Copper: yellow color Constantan: silver color
J	Iron	White	Constantan	Red	Iron: magnetic Constantan: non-magnetic
E	Chromel	Purple	Constantan	Red	Chromel: shiny metal Constantan: dull metal
K	Chromel	Yellow	Alumel	Red	Chromel: non-magnetic Alumel: magnetic
S	Platinum 10% Rhod.	Black	Pure Platinum	Red	
R	Platinum 13% Rhod.	Black	Pure Platinum	Red	
B	Platinum 30% Rhod.	Gray	Platinum 6% Rhodium	Red	

### 2.8.2 Field Input Wiring Connections

Figure 2-9 shows typical input connections. Both the local and remote termination assemblies provide for connection of up to 16 channels of voltage, millivoltage, or thermocouple input. Each termination assembly is arranged as follows:

- Long input signal terminal block with 32 terminals (two terminals per channel).
- The channels are consecutively numbered 1 to 16. Refer to Table 2-3 for terminal identification.
- Each channel is electrically isolated from other channels.
- Two short grounding terminal blocks on either side of the input signal terminal block. These terminals are used to ground the cable shields.

Refer to the following for input signal wiring:

1. Refer to the user's or system integrator's Process and Instrumentation Drawings to determine required cable connections for I/O power supplies and all field devices. Refer to Table 2-3 for connection data.
2. Prepare the shielded input signal cables as illustrated in Figure 2-10.



3. Use the following recommendation to prepare wire ends for connection of I/O power supplies (as necessary) and field devices to terminal blocks.
  - Do not solder multiple wires or the strands of multiple-strand wires for insertion into DIN rail terminal blocks. Solder is a malleable material and can loosen, causing open connections. Also, corrosion to the terminal block can result from the pickling agents or flux used with solder.
  - Use a pin-type crimp-on connector when two or more wires or a combination of wires and component leads (for example, resistors and stranded or solid wire) must be inserted into a DIN rail terminal block. Also, use a pin-type crimp-on connector for connections that will be moved regularly.

Wires and leads are crimped into the terminal and the terminal pin is inserted into the selected connection. Moore recommends the use of insulated crimp-on connectors available from electrical supply sources. Figure 2-8 shows an example of the use of a crimp-on connector.

#### NOTE

Use a crimping tool recommended by the connector manufacturer to ensure a strong mechanical, low electrical resistance connection.

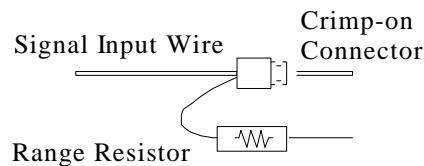

**FIGURE 2-8 Using a Pin-type Crimp-on Connector**

4. Use the following torque specifications when connecting terminals in DIN rail terminal blocks:
  - LMI (gray) DIN rail terminal blocks: 3.5 to 5.5 in. lbs.
  - Phoenix (green) DIN rail terminal blocks: 6.5 to 8.5 in. lbs.
5. Complete the necessary connections for each configured channel.



Electrical shock hazard. Remove power from all involved wires and terminals.

**TABLE 2-3 Termination Assembly Channel/Terminal Identification (1)**

<b>INPUT WIRE Vdc/TC</b>	<b>CHAN. 1 TERM.</b>	<b>CHAN. 2 TERM.</b>	<b>CHAN. 3 TERM.</b>	<b>CHAN. 4 TERM.</b>	<b>CHAN. 5 TERM.</b>	<b>CHAN. 6 TERM.</b>	<b>CHAN. 7 TERM.</b>	<b>CHAN. 8 TERM.</b>
+	1	3	5	7	9	11	13	15
-	2	4	6	8	10	12	14	16
<b>INPUT WIRE VDC/TO</b>	<b>CAN. 9 TERM.</b>	<b>CAN. 10 TERM.</b>	<b>CAN. 11 TERM.</b>	<b>CAN. 12 TERM.</b>	<b>CAN. 13 TERM.</b>	<b>CAN. 14 TERM.</b>	<b>CAN. 15 TERM.</b>	<b>CAN. 16 TERM.</b>
+	17	19	21	23	25	27	29	31
-	18	20	22	24	26	28	30	32

Notes:

1. Table supports both the VIM Termination Strip and the VIM Marshalled Termination Assembly.
2. Channel numbers (CHAN.) and wire polarities are printed on the assembly. Terminal Strip numbers (TERM.) are molded into the assembly terminals.
3. Ground Terminals may be used as tie points for signal cable shields.

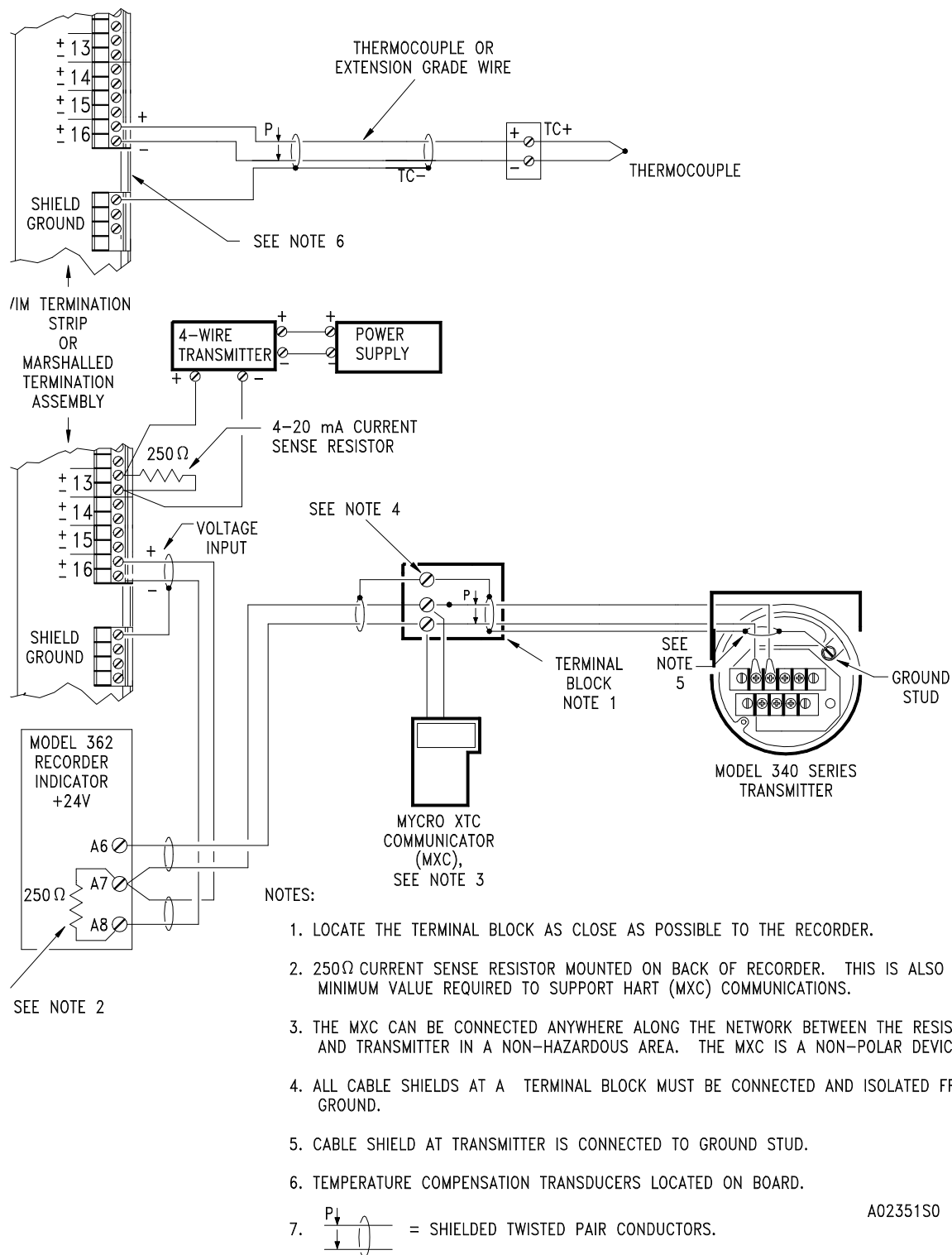

**FIGURE 2-9 Typical Signal Input Connections**

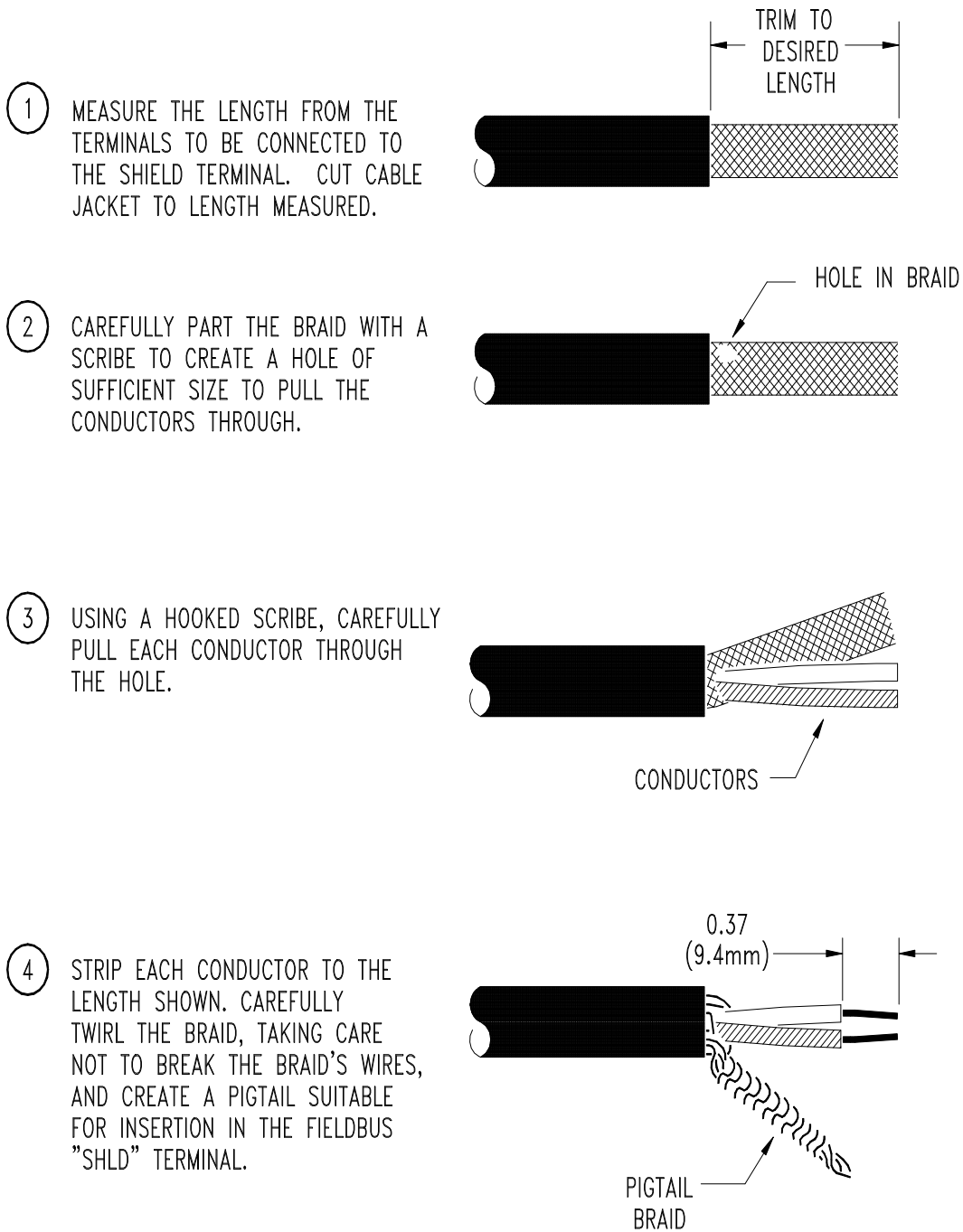

SIGNAL CABLE END PREPARATION

**FIGURE 2-10 Signal Input Cable End Preparation**

A0222000

### 2.8.3 Unterminated I/O Cable Assembly Connections

Connect field devices to user-supplied terminations. Table 2-4 lists the wire color and identification information needed for termination. Refer to user wiring diagrams as necessary.



Electrical shock hazard. Remove power from all involved wires and terminals.

### 2.8.4 Configuration

The VIM and its associated control module must be configured before being placed on-line. Details are provided in the *ProcessSuite 4-mation Configuration Guide* (UM39-14).

After the initial VIM power-up routine has been successfully completed, the VIM's OK LED will flash green and black (OFF) indicating an unconfigured module. When the control module recognizes that the VIM is on-line, it will automatically download the proper configuration to the VIM. When the configuration is accepted, the OK LED will be set to solid green.

If the VIM is non-redundant, the control module will ENABLE the VIM by setting its ACTIVE LED to solid green, thereby placing it in service. If the VIM is one of a redundant pair and the other VIM is in service, the control module will DISABLE (ACTIVE LED = OFF) the VIM and place it in the standby mode.

## 2.9 APACS+ CALIBRATION VERIFICATION REQUIREMENTS — LONG TERM DRIFT

The APACS+ analog I/O is designed to minimize calibration drift and the need for re-calibration over the life of the product. Design improvements include:

- Elimination of adjustable potentiometers
- Elimination of adjustable resistors
- Use of high quality low drift components

Calibration is performed through mathematical compensation within the microprocessor program. This allows the use of matched resistors for voltage dividers and minimizes the problem of temperature coefficient matching.

Because the other sources of drift have been minimized, the dominant contributor to analog long term drift for all analog modules is the voltage reference used for the A/D or D/A circuit. Manufacturer data specifies a typical long term drift in terms of the first 1000 hours of operation. Typically, drift for the next 1000 hours will be less. In fact, studies have shown that the I/f noise model is valid for long term drift. This model indicates that the drift will be proportional to the square root of the time period as a limiting factor.

20ppm drift over the first 1000 hours is a typical drift for a high quality reference such as used in all APACS+ analog modules. Using 30ppm to account for the other secondary drifts, such as precision resistor ratios, indicate it would, on average, take 126 years for a module to drift 0.1% from original calibration due to this mechanism. Drift of 0.05% would on average take 31 years.

Long term drifts significantly greater than typical would be due to flaws inherent to the manufacturing process of the individual components or the module itself. APACS+ screens out even these unlikely occurrences through multiple additional layers of control. In addition, the range of compensation is restricted to prevent compensation for inherently defective devices. All APACS+ modules go through environmental stress screening before functional testing and calibration to precipitate failure of weak components. Finally, all APACS+ modules go through an elevated temperature burn-in followed by a final functional verification including calibration.

For these reasons, **Moore does not recommend the need for periodic verification of analog calibration more often than once every ten years if the system design can accommodate a 0.1% drift from original calibration.** This recommendation is based on the assumption that specified limits for the modules have not been exceeded.

Calibration-related error messages and/or known over stress conditions being applied to analog I/O points could indicate the need for verification before the end of a ten year period.

■

TABLE 2-4 Underterminated I/O Cable Assembly

J1, PIN	P2, PIN	WIRE/STRI PE COLOR	WIRE IDENT
A2	75	WH/BLK	U1 -
C2	74	WH/RED	1 +
E2	73	WH/BLUE	1 -
A4	65	WH/GRN	U1 +
C4	49	WH/BRN	2 +
E4	64	WH/OR	2 -
A6	91	WH/YEL	U2 -
C6	104	WH/VIO	3 +
E6	90	WH/GRAY	3 -
A8	100	RED/WH	U2 +
C8	101	RED/BLK	4 +
E8	102	RED/BLUE	4 -
A10	36	RED/GRN	NC
C10	47	RED/BRN	5 +
E10	46	RED/OR	5 -
A12	11	RED/YEL	NC
C12	10	RED/VIO	6 +
E12	24	RED/GRAY	6 -
A14	22	BLUE/WH	NC
C14	8	BLUE/BLK	7 +
E14	21	BLUE/RED	7 -
A16	14	BLUE/GRN	NC
C16	27	BLUE/BRN	8 +
E16	13	BLUE/OR	8 -
A18	44	BLUE/YEL	NC
C18	43	BLUE/VIO	9 +
E18	45	BLUE/GRAY	9 -
A20	56	GRN/WH	NC
C20	57	GRN/BLK	10 +
E20	41	GRN/RED	10 -

J1, PIN	P2, PIN	WIRE/STRI PE COLOR	WIRE IDENT
A22	16	GRN/BLUE	NC
C22	3	GRN/BRN	11 +
E22	17	GRN/OR	11 -
A24	6	GRN/YEL	NC
C24	19	GRN/VIO	12 +
E24	5	GRN/GRAY	12 -
A26	70	OR/WH	NC
C26	71	OR/BLK	13 +
E26	72	OR/RED	13 -
A28	85	OR/BLUE	NC
C28	98	OR/GRN	14 +
E28	84	OR/BRN	14 -
A30	96	OR/YEL	NC
C30	94	OR/VIO	15 +
E30	95	OR/GRAY	15 -
A32	92	YEL/WH	NC
C32	78	YEL/BLK	16 +
E32	79	YEL/RED	16 -
Shield Wire	1	Shield Wire	-----

## Notes:

1. Color for wire/stripe
2. NC = No Connection

### 3.0 MAINTENANCE - See Danger Alert on the last page

The APACS+ Voltage Input Module (VIM) and its associated assemblies require minimal maintenance. Some routine maintenance is recommended in the form of a visual inspection and a possible cleaning.

#### 3.1 TOOL AND EQUIPMENT REQUIREMENTS

The following tools and equipment are necessary for servicing:

- Common electronic servicing hand tools
- Digital Multimeter

#### 3.2 VISUAL INSPECTION

The VIM and its associated assemblies should be subjected to a periodic visual inspection. The frequency of inspection will depend on the severity of the operating environment. The primary aim of the inspection is to reveal any excessive accumulation of dust, dirt, or other foreign material adhering to the surfaces of the VIM Termination Strip and protective covers of the VIM. Accumulation of dirt and dust prevents efficient heat dissipation and may cause module or system failure. An VIM installed in a cabinet complying with the NEMA 12/IP55 specification need not be inspected for cleanliness. Refer to section 3.3 for cleaning instructions.

#### 3.3 CLEANING

Cleaning a VIM involves brushing or vacuuming the protective covers to restore cooling efficiency that may have been degraded by accumulated dust.

Cleaning a VIM Termination Strip or VIM Marshalled Termination Assembly involves careful brushing and vacuuming to remove accumulated dust and dirt harboring chemical particulate that may accelerate terminal or connector contact corrosion. Be careful not to disturb the wiring.

#### 3.4 TROUBLESHOOTING

Errors are annunciated by a module's status LEDs and displayed as error codes and messages in *4-mation*. The VIM's status LEDs are located on its bezel. For a description of the error codes and messages, refer to *Module Diagnostic Error Codes* (document CG39-19, located in binder UM39-14). Troubleshooting entails observing the status LEDs and reading the error codes and messages, then referring to Table 3-1 and configuration guide CG39-19 to determine the course of action.

Interconnect I/O Cable pin assignments are given in Table 2-2. These are provided for troubleshooting a suspect cable. As necessary, check field wiring and field located devices.



**TABLE 3-1 LED Indications**

LED NAME	LED INDICATION	MODULE STATUS	ACTION
OK	Black (Off)	No 24V power input to VIM	1. Properly seat the module 2. Troubleshoot or replace the 24V power supply
		VIM on-board power supply failure	Replace module
OK	Solid Green	Module is OK. Configured, with no faults or failures.	NONE
OK	Flashing Green/Black	Module is not configured. No faults or failures.	Download configuration
OK	Solid Red	Module severe failure (Class 4 error)	Replace module
OK	Flashing Red/Green	Class 2 error detected	Check <i>4-mation</i> error description for user action
OK	Flashing (1/sec.) Red/Black	Class 3 error detected	Check <i>4-mation</i> error description for user action
OK	Flashing (5/sec.) Red/Black	IOBUS communications error	1. Check <i>4-mation</i> error description for user action 2. Check IOBUS cables 3. Check control module 4. Check module rack backplane jumpers 5. Replace module
ACTIVE	Solid Green	Module Enabled	
	Black (Off)	Module Disabled (in Standby Mode or off-line)	

A digital multimeter can be used to test field input circuitry for correct wiring and input signals to the termination assembly. Power-off continuity tests can be used to test for correct wiring. When performing power-on AC voltage tests, refer to section 6 for the voltage levels required at VIM input terminals.



Electrical shock hazard. Follow safe electrical troubleshooting practices when testing for the presence of high voltage AC input signals.

Return a failed assembly to the factory for repair; see section 3.11 for spare and replacement parts and sections 3.9 and 3.10 for return for repair procedures. There are no user serviceable parts within a VIM Termination Strip, VIM, or VIM Marshalled Termination Assembly.

### 3.5 VIM REMOVAL/REPLACEMENT

A module can be removed from or installed in the MODULRAC, SIXRAC, or UNIRAC without removing power from the module slot, from I/O circuits, or from the rack.

#### 3.5.1 Removal

1. As shown in Figure 2-7, pull open the bezel's pivoted top and bottom handles to expose the module's slotted captive mounting screws. Loosen the screws.
2. Grasp the top and bottom handles and pull the module from the card cage.
3. Place the module in a static shielding bag and package for return. See section 3.9 or 3.10 for return instructions.

#### 3.5.2 Replacement

1. Remove the replacement VIM from its protective bag. The module may be safely handled as the circuit card is shielded from access by protective covers.
2. If the module is already keyed, confirm that its keying matches that of the removed module. If not keyed, key the replacement VIM as described in section 2.7.1.
3. Insert the VIM in its module rack slot. Firmly seat the module in the backplane and termination board connectors. A properly seated module will have the rear of its bezel flush against the rack's rails. A keyed module that is not matched to a slot will not engage the backplane and termination strip connectors or seat flush against the rack's front rails.
4. As shown in Figure 2-7, pull open the bezel's pivoted top and bottom handles to expose the module's slotted captive mounting screws and secure the module to the top and bottom rails. Close the bezel's handles when finished.



Do not use the captive mounting screws to seat the module.  
Damage to the bezel can result.

### **3.6 VIM TERMINATION STRIP REMOVAL/REPLACEMENT**

#### **3.6.1 Removal**

Refer to Figure 2-2 and the following procedure:

1. As necessary, take appropriate steps to shutdown the processes monitored or controlled by the field devices connected to the VIM Termination Strip.
2. Remove the associated VIM from its slot in the MODULRAC, SIXRAC, or UNIRAC. Place the VIM in a static shielded bag for protection.
3. Disconnect signal cables from the VIM Termination Strip.

#### **IMPORTANT**

All signal and power cables should be labeled for correct reconnection.

4. Loosen the VIM Termination Strip's captive mounting screws. Gently lift the bottom of the strip in an arc until it is free of its alignment pin located immediately above the MOORE logo. Pull the top of the strip from the grooved backplane spacer and lift it from the rack.

#### **3.6.2 Replacement**

Refer to Figure 2-2 and the following procedure:

1. Refer to section 2.5 and install the replacement VIM Termination Strip.
2. Reconnect the signal and power cables.
3. Install the VIM. See section 3.5.

### **3.7 VIM MARSHALLED TERMINATION ASSEMBLY REMOVAL/REPLACEMENT**

#### **3.7.1 Removal**

Refer to Figures 2-3 and 2-5 and the following procedure:

1. As necessary, take appropriate steps to shutdown the processes monitored or controlled by the field devices connected to the VIM Marshalled Termination Assembly.
2. Remove the associated VIM from its slot in the MODULRAC, SIXRAC, or UNIRAC. Place the VIM in a static shielded bag for protection.
3. Disconnect signal cables from the VIM Marshalled Termination Assembly.

---

**IMPORTANT**

All signal and power cables should be labeled for correct reconnection.

4. Refer to Figure 2-5. Press down on the Marshalled Termination Assembly and carefully pull it away from the DIN rail.

**3.7.2 Replacement**

Refer to the following procedure:

1. Refer to section 2.6 and install the replacement Marshalled Termination Assembly.
2. Reconnect the signal cables.
3. Install the VIM. See section 3.5.

**3.8 INTERCONNECT I/O CABLE ASSEMBLY REMOVAL/REPLACEMENT****3.8.1 Removal**

Refer to Figure 2-2 and the following procedure:

1. As necessary, take appropriate steps to shutdown the processes monitored or controlled by the field devices connected to the VIM Marshalled Termination Assembly.
2. Remove the associated VIM from its slot in the MODULRAC, SIXRAC, or UNIRAC. Place the VIM in a static shielded bag for protection.
3. Disconnect Interconnect I/O Cable Assembly connector P2 or individual connections from the termination assembly. All individual connections should be labeled for correct reconnection.
4. Loosen the captive mounting screws on the cable connector. Gently lift the bottom of the connector in an arc until the connector is free of its alignment pin. Pull the top of the cable connector from the grooved backplane spacer and lift it from the rack.
5. Remove the Interconnect I/O Cable Assembly from the cable tray or other cable routing equipment.

### 3.8.2 Replacement

Refer to Figure 2-2 and the following procedure:

1. Route the Interconnect I/O Cable Assembly between the MODULRAC, SIXRAC, or UNIRAC and the marshalling cabinet.
2. Label and key the replacement cable as described in section 2.6.3.
3. Reconnect replacement cable as described in section 2.8.2.
4. Install the VIM. See section 3.5.

### 3.9 RETURN OF EQUIPMENT WITHIN NORTH AMERICA

If an VIM needs to be returned for any reason, perform the following:

#### To Return Equipment

- Call the Repair Order Group at (215) 646-7400, ext 4RMA (4762) weekdays between 8:00 a.m. and 4:45 p.m. eastern time to obtain an RMA number. Mark the RMA number prominently on the outside of the shipment.
- When calling for an RMA number, provide the reason for the return. If returning equipment for repair, failure information (e.g. error code, failure symptom, installation environment) will be requested. Supply a purchase order number for repairs.

#### Material Safety Data Sheet

A Material Safety Data Sheet (MSDS) must be included with each item being returned that was stored or used anywhere hazardous materials were present.

#### Packaging

Package assembly in original shipping materials. Otherwise, package it for safe shipment or contact the factory for shipping recommendations. A module must be placed inside a static shielding bag to protect it from electrostatic discharge.

### 3.10 RETURN OF EQUIPMENT OUTSIDE OF NORTH AMERICA

Contact the appropriate Moore product support group listed in section 1.2 of this Instruction. Provide the reason for the return. For repairs, supply a purchase order number. Request equipment packaging and shipping instructions.

### 3.11 SPARE AND REPLACEMENT PARTS

One spare Voltage Input Module (VIM) should be stocked for every 1 to 20 in service. Spare and replacement assemblies can be ordered from one the addresses in the Warranty statement or through a local Moore representative. Assembly part numbers are stated in section 5 and printed on most modules. When ordering, provide the model number from the module's nameplate to be replaced or spared. A purchase order number should also be included.

### 3.12 MAINTENANCE RECORDS

An accurate record keeping system for tracking maintenance operations should be established and kept up to date. Data extracted from the record may serve as a base for ordering maintenance supplies, including spare parts. The record may also be useful as a troubleshooting tool. In addition, maintenance records may be required to provide documentary information in association with a service contract. It is suggested that the following information be recorded:

1. Date of service incident
2. Name or initials of service person
3. Brief description of incident symptoms and repairs performed
4. Replacement part or assembly number
5. Software compatibility code of original part
6. Software code of replacement part
7. Serial number of original part
8. Serial number of replacement part
9. Issue number of original circuit module
10. Issue number of replacement circuit module
11. Date of completion

There are no user serviceable parts within a VIM, a VIM Termination Strip or a Marshalled Termination Assembly.

■

## 4.0 CIRCUIT DESCRIPTION

The following subsections describe the various circuit elements of the VIM and the processing of a thermocouple input signal. Processing of a voltage input signal is similar except the thermocouple burnout detection and temperature sensor selection are not applicable. Most VIM functions are performed or controlled by the CPU. A block diagram of the VIM is shown in Figure 4-1.

The VIM consists of the following circuit elements:

- 16 Voltage Input circuits—Process analog input signals.
- 16 Channel Multiplexer—Performs time-division multiplexing of input signals.
- Programmable Gain Amplifier—Performs on-the-fly signal conditioning of each input channel.
- Analog-to-Digital Converter—Converts analog input signals to digital data.
- Calibrator—Provides precision calibration voltage.
- TC Burnout Detector—Indicates when a TC fails.
- Sensor Selector—Provides ice point temperature reference signal for TC inputs.
- CPU—Performs general control functions and digital data interfacing to IOBUS .
- Memory (RAM and EPROM)—Stores module configuration parameters.
- IOBUS Modem—Provides digital data and command conversion needed for communication.
- LED Indicators (on module bezel)—An ACTIVE LED indicates that the module is enabled. An OK LED indicates the module status.
- Power Supply—24 Vdc to multi-voltage dc converter

### 4.1 THERMOCOUPLE INPUT CIRCUITRY

Pairs of thermocouple wires are connected to terminal blocks mounted on an isothermal (same temperature) assembly on either style of VIM termination assembly. The wires themselves create two dissimilar metallic junctions which generate a thermal EMF (offset) proportional to the junction's ambient temperature. This offset becomes an unwanted addition to the input signal.

The isothermal assembly is an electrical insulator but a good heat conductor and serves to hold both junctions to the same temperature. The metallic junctions take the place of an “ice bath” and become a Reference Junction. In order to determine the true junction temperature of the field thermocouple, the VIM must compensate the input signal for the reference junction offset.

To do this, the VIM must be able to sense the temperature of the isothermal assembly where the TCs are connected. Two Sensors mounted on the isothermal assembly provide this information to the VIM.

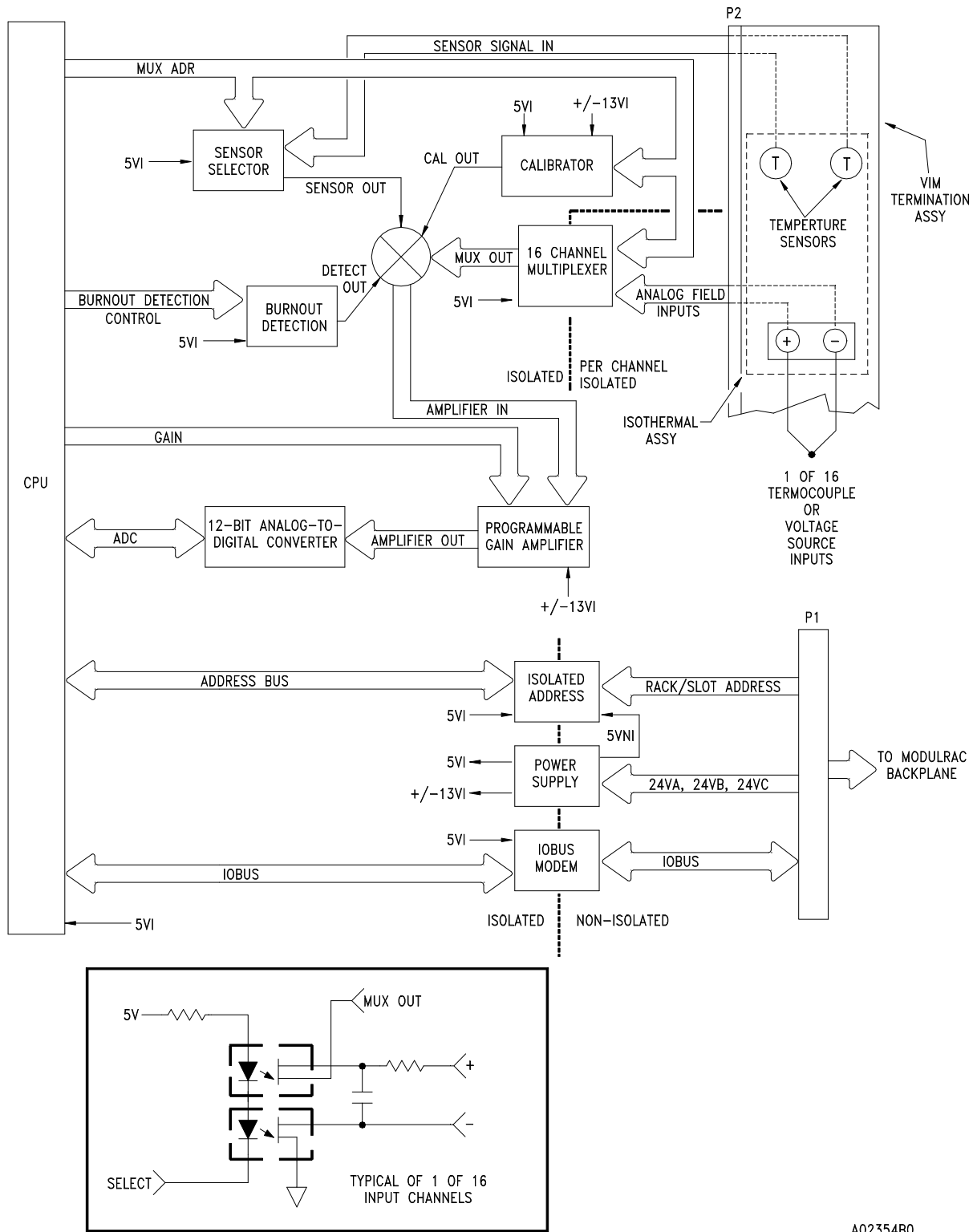

FIGURE 4-1 VIM Block Diagram



## 4.2 SENSOR SELECTION

Two temperature sensors on the Isothermal Assembly are electrically isolated from, but thermally coupled to, all thermocouple terminals. These sensors sense the top and bottom temperatures of the terminating blocks and produce a precision 1 mV/C° output signal.

The CPU periodically switches on the Sensor Selector which inputs the combined SENSOR OUT signals into a Programmable Gain Amplifier for amplification and A/D converter for digitizing. The digitized reference junction signal is fed into the CPU where the software determines the offset (mV) as referenced against the ice point temperature. When the CPU reads the thermocouple signal, it subtracts the offset from the signal. The CPU then converts this signal voltage into a temperature.

## 4.3 MULTIPLEXING, AMPLIFICATION, AND DIGITIZING

Thermocouple generated millivolt (mV) signals from the isothermal assembly are fed into isolated channels of a 16 channel multiplexer. The output from the Multiplexer (MUX OUT) is fed into a Programmable Gain Amplifier (PGA) whose gain is controlled by the CPU. The gain is automatically adjusted (autoranging) to match the input signal to the full scale range of the A/D converter to provide maximum accuracy without the need for user recalibration.

AMPLIFIER OUT from the PGA is digitized by an A/D Converter whose output becomes a precision digital voltmeter input to the CPU. In order to find the true junction temperature of the field thermocouple, the offset corresponding to the reference junction temperature is subtracted from the thermocouple input signal. After performing this operation, the CPU performs a voltage to temperature conversion, including linearization, by accessing the appropriate thermocouple table. The most popular thermocouple curves are stored in CPU ROM as lookup tables. The computed temperature data is transmitted over the IOBUS via the IOBUS Modem.

## 4.4 IOBUS MODEM

The IOBUS elements consists of an IOBUS Modem and dual IOBUS Line Drivers/ Receivers. The CPU supervises IOBUS communications through handshaking operations with the IOBUS Modem. The IOBUS Modem performs the following:

- Converts received IOBUS data into a format for data-processing.
- Converts digitized field data from the CPU into a format for transmission over the IOBUS to a control module (e.g., CCM).

## 4.5 THERMOCOUPLE BURNOUT DETECTION

A Burnout Detection circuit provides for the detection of a failed thermocouple. Under the control of the CPU, the Burnout Detector alternately outputs +5 and -5 volt pulses into a TC-configured channel as it is multiplexed. The combination of low thermocouple impedance and input signal filtering averages the +/-5 volts to a very minor ripple on the input signal.

Should a thermocouple burn out (infinite impedance) or develop a high impedance fault, a significant ripple voltage would be generated for that channel and detected by the CPU. The action taken by the CPU depends upon the BURNOUT configuration parameter selected:

- **DISABLE:** Burn out detection is disabled.
- **UP:** Burn out detection enabled. Output returned to maximum value.
- **DOWN:** Burn out detection enabled. Output returned to minimum value.

#### **4.6 CALIBRATOR**

Periodically, the CPU turns on the automatic Calibrator circuit. The Calibrator has a precision 5 volt regulator, the output of which is divided to create a series of precision output voltages. These outputs (CAL OUT) are signal input references against which the A/D Converter is software calibrated.

#### **4.7 VIM REDUNDANCY**

VIM redundancy is accomplished by rack-to-rack type redundancy through pairs of duplicate racks of I/O and control modules that share a common I/O termination such as the VIM Marshallled Termination Assembly.

In a redundant pair of racks, the VIM that is in the verify mode is identified by a solid green OK LED and a black (OFF) ACTIVE LED. A solid green ACTIVE LED indicates an enabled module.

#### **4.8 VIM DIAGNOSTICS**

Part of the VIM program includes the execution of diagnostics that can detect hardware errors. Errors are annunciated by LEDs located on the front bezel of the VIM. The OK LED is the principal error annunciator. The green ACTIVE LED lights if the module is enabled. A redundant VIM in the verify mode will show a solid green OK and black (OFF) ACTIVE LEDs.

At initial turn on, the VIM's CPU uses a common start up routine to perform certain self-diagnostics such as ROM and RAM tests and to setup specific board functions. If the common start up routine is successful, the OK LED will be set to a solid green and the VIM begins to execute common I/O board diagnostics; if not successful, the OK LED will be set to a flashing red color at a 1 second flash rate. *4-mation* software provides additional diagnostic and status displays.

■

## 5.0 MODEL DESIGNATION

Refer to Figure 5-1 to decode the VIM model designation.

### IMPORTANT

Before installing, applying power, or servicing, review the model designation on the nameplate and this section for required power, options, and electrical classification.

```
VIM  C B N   Voltage Input Module (VIM)
      T T T
      * * .)  ELECTRICAL APPROVALS: N=Not Required
      * .)))  DESIGN LEVEL: Current Design
      .)))))  REVISION LEVEL: A to Z
```

**FIGURE 5-1 Model Designation**

## 5.1 ACCESSORIES

Table 5-1 lists the available VIM accessories.

**TABLE 5-1 VIM Accessories**

PART NUMBER	DESCRIPTION
16171-30	VIM Temperature Transducer Kit. When a VIM local or marshalled termination cannot be used, the kit provides isothermal compensation at a user supplied thermocouple termination assembly. It must be used with an unterminated Interconnect I/O Cable.
16114-97	Marshalling Utility Panel (Figure 2-2) Includes installed wire ducts and DIN rails for mounting APACS marshalled termination assemblies. For installation in an APACS MODULPAC cabinet.
16114-12	Blank Utility Panel (Figure 2-2) Similar to above but without installed ducts and rails. For installation in a MODULPAC cabinet.
16056-562 (single piece number)	Mounting Ear (see Figure 2-8). Provides for a flat mounting of the VIM Marshalled Termination Assy. Four pieces required. Refer to section 2.6.2.
16056-468	End Stop Kit. End Stops prevent the sliding of an VIM Marshalled Termination Assembly along the mounting DIN rail.

## 5.2 OPTIONS

Table 5-2 lists the available VIM options. A selection of the type and quantity of termination assemblies must be made by the user. When marshalling termination assemblies are selected, a selection from the list of Interconnect I/O Cables must also be made.

**TABLE 5-2 VIM Options**

<b>PART NUMBER</b>	<b>DESCRIPTION</b>
16187-1	VIM Local Termination Strip
16170-1	VIM Marshalled Termination Assembly
16805-5	VIM DIN Rail Marshalled Termination Assembly
16137-122	Marshalled Interconnect I/O Cable Assembly 5.7 ft. (1.75 m)
16137-114	Marshalled Interconnect I/O Cable Assembly 9.8 ft. (3 m)
16137-115	Marshalled Interconnect I/O Cable Assembly 26.2 ft. (8 m)
16137-116	Marshalled Interconnect I/O Cable Assembly 49.2 ft. (15 m)
16137-117	Marshalled Interconnect I/O Cable Assembly 98.4 ft. (30 m)
16137-118	Unterminated Interconnect I/O Cable Assembly 9.8 ft. (3 m)
16137-119	Unterminated Interconnect I/O Cable Assembly 26.2 ft. (8 m)
16137-120	Unterminated Interconnect I/O Cable Assembly 49.2 ft. (15 m)
16137-121	Unterminated Interconnect I/O Cable Assembly 98.4 ft. (30 m)

■

## 6.0 SPECIFICATIONS

This section lists specifications for the Voltage Input Module (VIM).

### 6.1 MODULE SPECIFICATIONS

Refer to Table 6-1 for VIM specifications.

**TABLE 6-1 VIM Specifications**

CATEGORY	SPECIFICATION	DATA
Mechanical	Module Weight	4.25 lbs. (1.9 kg.)
Power Requirement	Voltage	24 Vdc +/- 10% (from module rack backplane)
	Current, Steady State	0.14 Amperes
	Current, Inrush	1.1 Amperes
	Current, Start Up	0.2 Amperes
Module	Channels per Module	16
	Electrical Isolation	30 V channel to channel, tested to 200 Vdc 600 V CSA each channel to CPU, IOBUS, and ground Tested at 3734 Vdc for 1 second
	Input Over Voltage Protection	±30 V
	Heat Dissipation	10 BTU/hour
	Linearity	≤0.05%
	A/D Conversion Resolution	≥12 bits
	Ambient Temperature Effect	≤0.1% of span for 50°C ΔT (±20 ppm/°C)
	Common Mode Rejection	120 dB with 100Ω maximum source imbalance
	Input Impedance	> 1 Meg. Ohm at DC
Minimum Module Scan Time	150 msec.	
Thermocouple Inputs	Ranges	J: -210 to 1200°C (-346 to 2192°F) K: -270 to 1372°C (-454 to 2501°F) E: -270 to 1000°C (-454 to 1832°F) T: -270 to 400°C (-454 to 752°F) S: -50 to 1767°C (-58 to 3212°F) R: -50 to 1767°C (-58 to 3212°F) N1: 0 to 1300°C (32 to 2372°F) N2: -270 to 400°C (-454 to 752°F) B: 42 to 1820°C (108 to 3300°F)
	Accuracy	J, K, E, T, R, N, B: ±1.0°C S: ±2.0°C

**TABLE 6-1 VIM Module Specifications (Continued)**

CATEGORY	SPECIFICATION	DATA
Thermocouple Inputs (Continued)	Resolution	J, E, T: 0.5°C K, S, R, N: 1.0°C B: 2.0°C
	Repeatability	J, E, T, K, S, R, N: ±1.0°C B: ±2.0°C
	Conformity to NBS 125 Tables	≤±0.05°C
	Agency Approvals	ABS approved CSA and FM approved for Class I, Division 2, Groups A, B, C, & D
Voltage Inputs	Range	-10.0 to 10.0 Vdc
	Accuracy	±0.1% of span for user ranges: (-10 to 10 V) (-5 to 5 V) (-1 to 1 V) (0 to 5 V) (1 to 5 V) - OR - ±0.2% ±25μV of reading
	Resolution	≤ 0.15% of reading
	Repeatability	≤±0.05% of full scale

## 6.2 ENVIRONMENTAL SPECIFICATIONS

Table 6-2 lists the environmental specifications for the VIM module.

**TABLE 6-2 VIM Environmental Specifications**

SPECIFICATIONS	DATA	REFERENCE STANDARDS
Ambient Temperature Range Operating Storage	0 to 60°C, 0.5°C/min -25 to 85°C, 10°/min	IEC 68-2-2 Test Bb IEC 68-2-14 Tests Na, Nb IEC 68-2-1 Tests Ab, Ad
Relative Humidity Operating: IEC 1131-2-RH2 Storage	5 to 95%, non-condensing 0 to 100%, condensing	IEC 68-2-3 Test Ca IEC 68-2-30 Test Dd
Vibration	10-150 Hz 2 g. max	IEC 68-2-6 Test F <sub>c</sub>
Mechanical Shock Acceleration Duration	15 g. 11 ms	IEC 68-2-27 Test E <sub>A</sub>

SPECIFICATIONS	DATA	REFERENCE STANDARDS
Corrosives	Class G3, 10+ years	ANSI/ISA S71.04
Radiated Emission, E-Field	30 MHz-230 MHz 30 db ( $\mu$ V/m) at 30 m 230 MHz-1000 MHz 37 db ( $\mu$ V/m) at 30 m	EN 55011 EN 50081-2
Conducted Emission Power Lines	0.15 MHz-0.5 MHz 79 dBm quasi-peak 0.5 MHz-30 MHz 73 dBm quasi-peak	EN 55011 EN 50081-2
Immunity, Conducted Electromagnetic Field	150 KHz-80 MHz, 10 V 10 k Hz-50 MHz, 1V	IEC 801-6/IEC 1000-4-6 IE 801-6
Immunity, Power Lines Surge	4 kV	IEC 801-5
	2 kV	ANSI/IEEE C62.41 (IEEE 587)
Immunity, Electrical Fast Transients and Signal Line Surge	4 kV Power Lines, 2 kV I/O	IEC 801-4/IEC 1000-4-4
	2.5 kV I/O	ANSI/IEEE C37.90 (Formally IEEE 472)
Immunity, Radiated E-Field	10 V/m, 27 MHz-1000 MHz	IEC 801-3
	10 V/m, 80 MHz-1000 MHz	IEC 1000-4-3
	10 V/m, 30 kHz-150 kHz	IEC 801-3
Immunity, Electrostatic Discharge	8 kV contact, 15 kV air	IEC 801-2/IEC 1000-4-2, Level 4
Altitude: IEC 1131-2	Up to 2000 meters	

### 6.3 ELECTRICAL CLASSIFICATION

This section provides certification agency ratings and hazardous locations precautions.

#### 6.3.1 Approvals (see important note)

Table 6-3 lists the agency approvals.

#### IMPORTANT

Before installing, applying power to, or servicing an ACM, see the module's nameplate for electrical classification.

**TABLE 6-3 Agency Approvals**

<b>AGENCY</b>	<b>STANDARD</b>	<b>STANDARD TITLE</b>
FM	FM Class 3611	Electrical Equipment for use in Class I, Div 2; Class II, Div 2; and Class III, Div 1 and 2 Hazardous Locations
CSA	C22.2 No.213	Non-Incendive Electrical Equipment for use in Class I, Div 2 Hazardous Locations
FM	ISA S82.01	Safety Standards for Electrical and Electronic Test, Measuring, Controlling, and Related Equipment
CSA	C22.2 No.142	Process and Control Equipment for Non-Hazardous Locations

### 6.3.2 CSA Hazardous Locations Precautions

This section provides CSA hazardous location precautions that should be observed by the user when installing or servicing the equipment described in this Instruction. These statements supplement those given in the preceding section.



Failure to observe the following precautions could result in an explosion hazard.

#### 6.3.2.1 Precautions - English

For Class I, Division 1 and Class I, Division 2 hazardous locations,

Use only factory-authorized replacement parts. Substitution of components can impair the suitability of this equipment for hazardous locations.

For Division 2 hazardous locations:

When the equipment described in this Instruction is installed without safety barriers, the following precautions should be observed. Switch off electrical power at its source (in non-hazardous location) before:

- Connecting or disconnecting power, signal, or other wiring
- Replacing a fuse, circuit board, or any other component connected to the electrical circuit



### 6.3.2.2 Précautions - Français

Emplacements dangereux de classe I, division 1 et classe I, division 2:

- Les pièces de rechange doivent être autorisées par l'usine. Les substitutions peuvent rendre cet appareil impropre à l'utilisation dans les emplacements dangereux.

Emplacement dangereux de division 2:

Lorsque l'appareil décrit dans la notice ci-jointe est installé sans barrières de sécurité, on doit couper l'alimentation électrique à la source (hors de l'emplacement dangereux) avant d'effectuer les opérations suivantes:

- Branchement ou débranchement d'un circuit de puissance, de signalisation ou autre
- Remplacement d'un fusible, d'une carte de circuit imprimé ou de tout autre élément connecté au circuit électrique.

## 6.4 ELECTROMAGNETIC COMPATIBILITY (EMC)

This product has been tested per the European Union's EMC Directive. See the Declaration of Conformity statement at the back of this Instruction. Refer to section 2.2.1, for considerations affecting EMC compliance.

■

## EC Declaration of Conformity EG-Konformitätserklärung

No. SHO001\_2009-07\_39VIM

Manufacturer: Siemens AG  
Hersteller: Industry IA SE EM  
Address: Wuerzburger Str. 121, 90766 Fuerth  
Anschrift: Bundesrepublik Deutschland  
Product description: APACS VIM 39VIMCCN  
Produktbezeichnung

The product described above in the form as delivered is in conformity with the provisions of the following European Directives:

**Das bezeichnete Produkt stimmt in der von uns in Verkehr gebrachten Ausführung mit den Vorschriften folgender Europäischer Richtlinien überein:**

- 2004/108/EC Council Directive on the approximation of the laws of the Member States relating to electromagnetic compatibility.
- EMC Richtlinie des Rates zur Angleichung der Rechtsvorschriften der Mitgliedstaaten über die elektromagnetische Verträglichkeit.

Spring House, 17.07.2009

Siemens AG

LYNNE HAY  
Manager, PAS R&D  
Name, function  
Name, Funktion

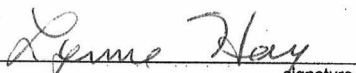
  
signature  
Unterschrift

Hans-Dieter Pletz  
CEO BS, IIA SE EM  
Name, function  
Name, Funktion

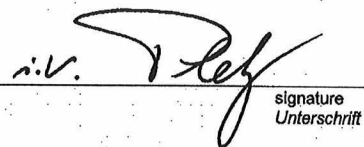
  
signature  
Unterschrift

Annex A is integral part of this declaration.

Anhang A ist integraler Bestandteil dieser Erklärung.

This declaration certifies the conformity to the specified directives but contains no assurance of properties.

The safety documentation accompanying the product shall be considered in detail.

Diese Erklärung bescheinigt die Übereinstimmung mit den genannten Richtlinien, ist jedoch keine Zusicherung von Eigenschaften  
Die Sicherheitshinweise der mitgelieferten Produktdokumentation sind zu beachten.

## Annex A to the EC Declaration of Conformity *Anhang A zur EG-Konformitätserklärung*

No. *SHO001\_2009-07\_39VIM*

Product description: **APACS VIM 39VIMCCN**  
*Produktbezeichnung*

---

Conformity to the Directives indicated on page 1 is assured through the application of the following standards (depending on versions):

*Die Konformität mit den auf Blatt 1 angeführten Richtlinien wird nachgewiesen durch die Einhaltung folgender Normen (variantenabhängig):*

<i>Direktive Richtlinie</i>	<i>Standard / Reference number Norm / Referenznummer</i>	<i>Edition Ausgabedatum</i>
2004/108/EC	EN 61000-6-4	2007
2004/108/EC	EN 61000-6-2	2005

## WARRANTY

The Company warrants all equipment manufactured by it and bearing its nameplate, and all repairs made by it, to be free from defects in material and workmanship under normal use and service. If any part of the equipment herein described, and sold by the Company, proves to be defective in material or workmanship and if such part is within twelve months from date of shipment from the Company's factory, returned to such factory, transportation charges prepaid, and if the same is found by the Company to be defective in material or workmanship, it will be replaced or repaired, free of charge, f.o.b. Company's factory. The Company assumes no liability for the consequence of its use or misuse by Purchaser, his employees or others. A defect in the meaning of this warranty in any part of said equipment shall not, when such part is capable of being renewed, repaired or replaced, operate to condemn such equipment. This warranty is expressly in lieu of all other warranties, guaranties, obligations, or liabilities, expressed or implied by the Company or its representatives. All statutory or implied warranties other than title are hereby expressly negated and excluded.

Warranty repair or replacement requires the equipment to be returned to one of the following addresses.

Equipment manufactured or sold by Moore Process Automation Solutions:

Moore Process Automation Solutions  
1201 Sumneytown Pike  
Spring House, PA 19477-0900 U.S.A

Equipment manufactured or sold by Moore Products Co. (Canada) Inc.:

Moore Products Co. (Canada) Inc.  
P.O. Box 370  
Brampton, Ontario L6V 2L3  
Canada

Equipment manufactured or sold by Moore Products Co. (UK) Ltd.:

Moore Products Co. (UK) Ltd.  
Copse Road  
Lufton Industrial Estate  
Yeovil, Somerset BA22 8RN  
England

The warranty will be null and void if repair is attempted without authorization by a member of the Moore Process Automation Solutions Service Department.





**DANGER**



**Electrical shock hazard  
Explosion hazard**

Will cause death, serious injury or property damage

- Remove power from all wires and terminals and verify that there are no hazardous voltages before working on equipment.
- In potentially hazardous atmosphere, remove power from equipment before connecting or disconnecting power, signal, or other circuit, or extracting/inserting module.
- Observe all pertinent regulations regarding installation in hazardous area.
- Ensure all devices are rated for hazardous (classified) locations.

