

GFK-2574A

July 2012

The VersaMax PROFINET Scanner (PNS) module interfaces a remote node of VersaMax modules to a PROFINET IO-Controller. The PROFINET Scanner scans the modules in its node, retrieving input data and providing output data, and publishes input data on the PROFINET Network at the configured production rate. The PNS manages PROFINET communication and module configuration between an IO-Controller and modules within the remote node. If network communications are lost, the PNS manages I/O states according to the individual module configurations.

The PNS is available in two versions to allow you to use the network media that meet the requirements of your application.

IC200PNS001: Two 10/100 Mbps copper interfaces

IC200PNS002: Two 100Mbps Multi-Mode fiber (MMF) ports

Features

- Supports redundant power supplies. Use of the second power supply is optional.
- Supports “hot swap” of a redundant power supply that is de-energized.
- Standard PROFINET alarm and diagnostics reporting.
- Supports configuration using Classless InterDomain Routing (CIDR) with subnetting and supernetting.
- Each network interface module can be connected into a daisy-chain/line, star, or ring (redundant media) topology.
- Supports Media Redundancy Protocol (MRP) client mode operation.
- Can be upgraded in the field; supports firmware updates via USB port.
- Provides Maintenance Mode to allow servicing of the remote node while maintaining network connections. (Requires firmware version 1.10 or later.)

Note: The USB port is for firmware upgrades only. It is not intended for permanent connection

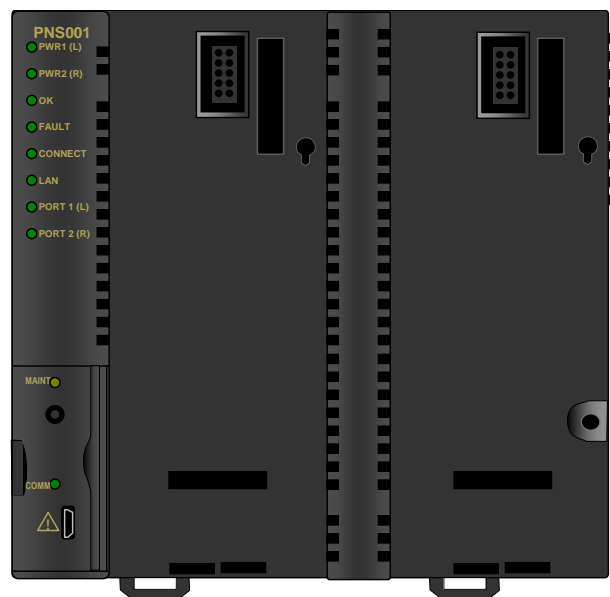

The PNS module’s main Remote IO functions include:

- Scanning all the modules within its stick (input and output scan).
- Publishing data onto the PROFINET network to an IO-Controller at a customer-specified production period.
- Receive data from an IO-Controller on the PROFINET network at a customer-specified production period.
- Managing PROFINET communication and module configuration between an IO-Controller and modules within the PNS node.
- Managing the state of the I/O when communications is lost
- Publishing fault information (alarms, diagnostics, etc.) to IO-Controller

Ordering Information

IC200PWR002	24 VDC Expanded 3.3 V Power Supply
IC200PWR012	24 VDC Expanded Isolated 3.3 V Power Supply
IC200PWR102	120/240 VAC Expanded 3.3 V Power Supply
IC200ACC200	Empty Filler Module, optional

GFK-2574A

Specifications

PROFINET Support	PROFINET Version 2.2 Class A IO-Device	
Power Consumption	IC200PNS001: 0.60A at 5VDC IC200PNS002: 1.10A at 5VDC	
Module Dimensions	Height: 132mm (5.2 inches), Width: 134mm (5.28 inches)	
Carrier Required	No. Carrier is integrated into the module	
Operating Temperature Range	0 to 60°C surrounding air temperature without a fan	
Number of Port Connectors	IC200PNS001: Two RJ-45 IC200PNS002: Two SC-Duplex	
USB Connector (for firmware upgrades)	One Micro-B connector. USB 2.0 compliant running at Full-speed (12 MHz).	
PNS Status and Control Bits	32 input status bits and 32 output control bits	
I/O Data Update on the PROFINET LAN	Configurable: 1ms, 2ms, 4ms, 8ms, 16ms, 32ms, 64ms, 128ms, 256ms and 512ms	
Number of IP addresses	One. Supports Classless Inter-Domain Routing (CIDR)	
Number of MAC Addresses	Three. One per external port and one internal. External MAC addresses are only used for specialized Ethernet protocols such as MRP or LLDP	
I/O Station Maximum Limits	Number of I/O Modules per station	Eight
	I/O data per station	2880 bytes total 1440 bytes of input data 1440 bytes of output data
RoHS Compliance	Yes	
Configuration	Configured using Proficy* Machine Edition when used with a PACSystems RX3i PROFINET Controller (PNC) module, as part of an RX3i PROFINET network. V2.2 GSDML file available for import into 3 rd -Party tools.	



For product standards, general operating specifications, and installation requirements, refer to the *VersaMax I/O Modules Manual*, GFK-1504.

For PNS installation, configuration and operating information, refer to the *VersaMax PROFINET Scanner User's Manual*, GFK-2721

Manuals can be downloaded from the Support website, <http://support.ge-ip.com>.

Installation in Hazardous Areas

The following information is for products bearing the UL marking for Hazardous Locations or ATEX marking for explosive atmospheres:

- EQUIPMENT LABELED WITH REFERENCE TO CLASS I, GROUPS A, B, C & D, DIV. 2 HAZARDOUS LOCATIONS IS SUITABLE FOR USE IN CLASS I, DIVISION 2, GROUPS A, B, C, D OR NON-HAZARDOUS LOCATIONS ONLY
- Equipment labeled with  II 3 G is suitable for use in Group 2 Category 3 environments.
- WARNING - EXPLOSION HAZARD - SUBSTITUTION OF COMPONENTS MAY IMPAIR SUITABILITY FOR CLASS I, DIVISION 2;
- WARNING - EXPLOSION HAZARD - WHEN IN HAZARDOUS LOCATIONS, TURN OFF POWER BEFORE REPLACING OR WIRING MODULES; AND
- WARNING - EXPLOSION HAZARD - DO NOT DISCONNECT EQUIPMENT UNLESS POWER HAS BEEN SWITCHED OFF OR THE AREA IS KNOWN TO BE NONHAZARDOUS.
-  WARNING - EXPLOSION HAZARD - USB PORT IS ONLY FOR USE IN NONHAZARDOUS LOCATIONS, DO NOT USE UNLESS AREA IS KNOWN TO BE NON-HAZARDOUS.

ATEX Marking

 II 3 G Ex nA IIC T5 X 0°C≤Ta≤60°C

Module Installation

Modules must be mounted on a DIN rail.

1. Allow sufficient finger clearance for opening PNS door.
2. Allow adequate clearance for communications port cables.
3. Allow adequate space for power wiring.

The PNS with power supply attached fits into a 70mm deep enclosure.

Rated thermal specifications are based on a minimum clearance of 5.1cm (2in) above and below the equipment and 2.54cm (1in) to the left of the PNS module.

You may need to allow more space for installation of cables and connectors than what is required for heat dissipation. To avoid impacting mechanical reliability and signal quality, cable installation must comply with the minimum bend radius specified by the cable manufacturer.

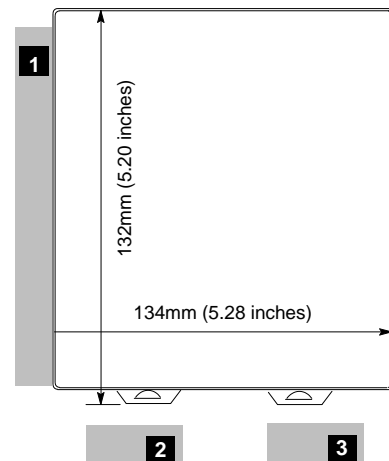

Installing the Module on a DIN Rail

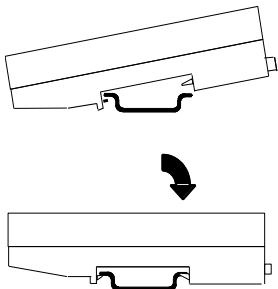

The PROFINET Scanner and connecting carriers must be installed on the same section of 35mm x 7.5mm DIN rail. The rail must have a conductive (unpainted) finish for proper grounding. For best resistance to vibration, the DIN rail should be installed on a panel using screws spaced approximately 6 inches (5.24cm) apart.

Modules snap easily onto the DIN rail. No tools are required for mounting or grounding to the rail.

GFK-2574A

Removing the Module from the DIN Rail

1. If the module is attached to the panel with a screw, remove the screw.
2. Slide the module along the DIN rail away from the other modules until the connector disengages.
3. With a small flathead screwdriver, pull the DIN rail latch tab outward while tilting the other end of the module down to disengage it from the DIN rail.

Panel-Mounting

For applications requiring maximum resistance to mechanical vibration and shock, the PROFINET scanner must be panel-mounted.

Note 1. Tolerances on all dimensions are +/- 0.13mm (0.005in) non-cumulative.

Note 2. 1-1.4Nm (10-12 in/lbs) of torque should be applied to M3.5 (#6-32) steel screw threaded into material containing internal threads and having a minimum thickness of 2.4mm (.093in).

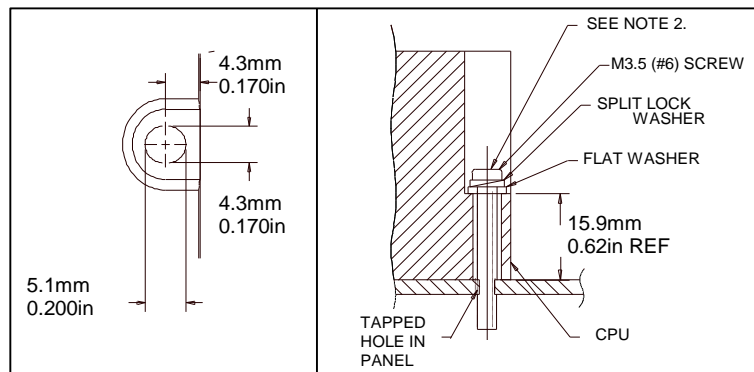

Grounding

The VersaMax PROFINET Scanner must have a separate shield ground connection to provide shielding for its two ports. Attach a wire with a stab-on connector to the grounding terminal on the bottom of the module. Connect a ring terminal on the other end of the wire to a grounded enclosure. Where the ring terminal contacts a painted enclosure panel, either install a star lock washer between the terminal and the panel to cut through the paint, or scrape the paint away down to clean, bare metal to ensure a good contact. Note: The star lock washer method is suitable for a shield ground, but not suitable for a safety ground.

Installing Power Supplies

Note: If only one power supply is used, an *IC200ACC200 Empty Filler module* may be installed in the empty power supply slot.

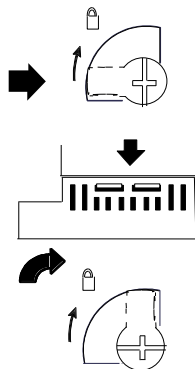

The latch on the power supply must be in the unlocked position, as illustrated. Power supplies can be installed in either or both locations on the PROFINET Scanner.

Align the connectors and the latch post and press the power supply module down firmly, until the two tabs on the bottom of the power supply click into place. Be sure the tabs are fully inserted in the slots.

Turn the latch to the locked position to secure the power supply.

To remove a Power Supply module from the PROFINET Scanner, source power into the power supply module must be turned off. The lever must be rotated to the unlocked position before detaching the Power Supply module.

Installing a Redundant Power Supply

A redundant power supply can be installed on the PROFINET Scanner without disrupting system operation:

1. Turn off the source power to the power supply that will be installed.
2. Without disturbing the operating power supply module, install the redundant power supply module in the PROFINET Scanner's empty power supply location.
3. Turn on the power source to the redundant supply, and check the PWR LED on the PROFINET Scanner to be sure it is supplying power.

Complete the power supply wiring as described in the installation instructions provided with the power supply.

Note: Isolated power supplies should not be mixed with non-isolated power supplies. If an isolated power supply is applied to a power slot on PNS or a booster carrier, all power supplies in that stick should be isolated power supplies.

There is no restriction on mixing non-isolated AC with non-isolated DC power supplies on either the PNS or a booster.

Swapping a Redundant Power Supply

If two power supplies are installed on the PROFINET Scanner and the power sources to both can be turned off independently, either one can be removed or replaced without disrupting system operation.

1. Check the PWR LEDs on the PROFINET Scanner to be sure that the module that is not being removed is currently supplying power.
2. Turn off the power source of the power supply module that will be removed.
3. Wait until the PWR LED for the module that is being removed goes off.
4. Remove the power supply as described above.

Do not attempt to do this if there is only one power supply, or if there are two power supplies with the same power source, requiring both to be powered down. Otherwise, the PROFINET Scanner may lose power and reboot.

Supported Network Media Types and Distances

<i>Media Type</i>	<i>Connector Type</i>	<i>Wavelength (nm)</i>	<i>Media Type</i>	<i>Core Size (µm)</i>	<i>Modal Bandwidth (MHz – Km)</i>	<i>Maximum Distance (m)</i>
100BASE-FX	SC or SC-Duplex	1300	MMF	62.5	500	2 – 2,000 (Full-Duplex) 2 – 400 (Half-Duplex)
				50	400	
				50	500	
10/100BASE-T	RJ45	-	CAT5/CAT5e/CAT6	-	-	100 (maximum)

PROFINET IO over wired infrastructure must be 100Mbps full-duplex or faster. The hardware is capable of operating at 10Mbps but should not be used for PROFINET unless it is PROFINET over wireless (802.11).

GFK-2574A

LEDs

The PNS has ten LEDs that indicate the presence of power and show the operating mode and status of the PNS. Two of the LEDs will be used to indicate network port link speed and activity.

LED	Color	State	Indication
PWR1 PWR2	Green	On, Solid	Power supply has power
	---	OFF	No power applied
OK	Green	On, Solid	PROFINET Scanner module is OK
	Amber	Fast Blink	Diagnostic data for a fatal error is being saved. When this completes, a fatal error blink-code is displayed or the module resets itself, depending on how it has been configured.
	---	OFF	PROFINET Scanner has unrecoverable fault.
FAULT	Amber	On, Solid	Fault detected within the PROFINET Scanner or on a VersaMax module. PROFINET diagnosis data is available.
	Red	Slow Blink	Invalid MAC addresses (Indicates an error if any MAC address is bad.)
	---	Off	No faults detected
CONNECT	Green	On, Solid	Connected: One or more PROFINET application relationships (ARs) have been established to this device.
	Amber	Slow Blink	The PROFINET Scanner has not been assigned a name.
		Fast Blink	PROFINET connection is being blocked because PROFINET Scanner is updating the firmware of a module in the node or PROFINET Scanner is in Maintenance mode.
	---	Off	Not connected
LAN	Green	Irregular Blink	Activity (this node). Network interface is processing packets.
	---	OFF	No activity
PORT 1 PORT 2	Green	On, Solid	Link connected 100 Mbps
		Irregular Blink	Activity (this port) 100 Mbps
	Amber	On, Solid	Link connected 10 Mbps
		Irregular Blink	Activity (this port) 10 Mbps
	---	OFF	No link
MAINT	Amber	Slow Blink	Maintenance Mode enabled.
		Off	Normal operation
COMM	Green	Irregular Blink	USB Port activity
		ON, solid	USB connection is active, but no data is being transferred
	---	Off	No activity on USB port

Note: Multiple LEDs can blink in patterns that indicate special conditions, such as a request for module identification. For additional information, refer to the *VersaMax PROFINET Scanner Manual*, GFK-2721.

Input Status Bits

The PROFINET Scanner's 32 bits of input status provide information about the scanner alongside the I/O module data. All status bits are active high.

Status Bits	Name	Description
1	Module OK	Indicates the health of the module. A value of 0 indicates the module is powering up or has failed. A value of 1 indicates the module is functioning properly.
2	Fault Present	Diagnosis data is available. Set to 1 whenever the FAULT LED is On; otherwise it is set to 0.
3	Port1 Link Up	1 = port is connected to another device and is operating correctly.
4	Port2 Link Up	0 = port is not connected to another device, or the port has some sort of error preventing communications.
5–8	Reserved	Set to 0
9	Power1 OK	Indicates whether or not the Power Supply is providing power to the PROFINET Scanner.
10	Power2 OK	
11–16	Reserved	Set to 0
17	Slot1 Clear Faults ACK	Used to acknowledge the slot's Clear Faults REQ command bit. When the PROFINET Scanner sees a Clear Faults REQ bit transition from 0 to 1, it clears the fault conditions for that slot. Once that process has completed (whether or not it succeeds), the PROFINET Scanner sets the corresponding status bit to 1. This signals to the application program that the attempt to clear the faults has completed. When the PROFINET Scanner sees the Clear Faults REQ transition from 1 to 0, it immediately sets this status bit to 0 too. This signals to the application program that the PROFINET Scanner has seen the transition to 0, so it is possible to signal another Clear Faults request.
18	Slot2 Clear Faults ACK	
19	Slot3 Clear Faults ACK	
20	Slot4 Clear Faults ACK	
21	Slot5 Clear Faults ACK	
22	Slot6 Clear Faults ACK	
23	Slot7 Clear Faults ACK	
24	Slot8 Clear Faults ACK	
25–32	Reserved	Set to 0

GFK-2574A

Important Product Information for this Release

Release History

Version	Firmware Release	Date	Comments
IC200PNS001-AB, IC200PNS002-AB	1.10	April 2012	Firmware revision 1.10 adds the Maintenance Mode feature and support for the IC200BEM003 PROFIBUS Master module. Conformal coated versions (IC200PNS00x-CAAB) available starting with this release.
IC200PNS001-AA, IC200PNS002-AA	1.00	July 2011	Initial release.

Updates

The following firmware upgrade kit can be downloaded from <http://support.ge-ip.com>:

VersaMax_IC200PNS001_002_R110.zip

Compatibility

The PROFINET Scanner module requires the following programming software version and power supplies:

RX3i PLC CPU Version Required	Firmware version 7.0 or later Version 7.13 or later required to use the IC200BEM003 PROFIBUS Master module
Programmer software	Proficy Machine Edition, version 7.0 SIM 1 or later Version 7.0 SIM 7 or later required to use the IC200BEM003 PROFIBUS Master module
Power supply requirements	The PNS supports the following Expanded 3.3V VersaMax power supplies: IC200PWR002 IC200PWR012 IC200PWR102
VersaMax Modules, Carriers, and Power Supplies	For a list of modules that can be used in a VersaMax PROFINET Scanner IO-Device, refer to the <i>VersaMax PROFINET Scanner Manual</i> , GFK-2721A or later. Note: The IC200PNS001 and IC200PNS002 can support up to eight IC200CMM020 modules in one I/O station.

Problems Resolved in This Release

Subject	Description
Alarms that disappear before being reported to the IO Controller may persist in PNS.	If an alarm condition is cleared before the alarm is sent to the IO Controller, that alarm may persist in the PNS diagnosis memory. In this case, after all alarms clear, the FAULT LED remains AMBER, On, Solid and the Fault Present bit in the Input Status Bits remains 1. The Diagnosis Viewer may show multiple, identical faults present in PNS Diagnosis memory. To clear these alarms, the PNS must be reset or the slot that the diagnosis alarm is reported against must be hot swapped.

New Features and Enhancements

New Feature	Description
Maintenance mode	<p>This feature allows the user to service the remote node while maintaining network connectivity.</p> <p>To enter maintenance mode, press and hold the MAINT pushbutton for at least 3 seconds. To exit maintenance mode, perform the same action.</p> <p>When the PNS module enters maintenance mode, the power is removed from backplane modules, the current PROFINET AR is disconnected and the PNS refuses any new request to establish an AR. The network functionality, including MRP is not affected.</p> <p>Note: If modules or carriers to the right of a Booster Power Supply need to be changed, you will need to remove power from the Booster Power Supply.</p>
Support for IC200BEM003 module	<p>The IC200BEM003 module is a PROFIBUS DP master module. It maps all data in PROFIBUS slaves to its own data and exchanges it with the PNS.</p> <p>RX3i CPU firmware 7.13 or later is required when using the IC200BEM003 module in a PNS rack.</p> <p>It is not supported to configure IC200BEM003 module in 3rd-party tools by importing GSDML.</p>

Restrictions and Open Issues

Subject	Description
PROFINET stack does not support IOCS (Input/Output Consumer Status).	<p>The PROFINET stack used for this release does not support Input/Output Consumer Status at the application level. This means the PNS cannot inform the PNC whether the data sent to PNS is correctly consumed at the I/O module. In the opposite direction, the PNS is also not able to know whether the data sent from PNS is correctly consumed at the CPU.</p> <p>The primary impact of this is that the PNS does not set point faults in the CPU for operational faults such as a loss of field power on a VersaMax module.</p>
Hold Last State default input value is not supported on a per-module basis.	<p>Other VersaMax NIU modules allow the user to configure an input default value on a per module basis that is used if communication with the module is lost. PROFINET does not provide an equivalent mechanism within an IO-Device such as the PNS. If a module is lost, it is marked bad and the IO-Controller decides the action of the input.</p>
Inconsistent Hold Last State values or System Mismatch errors when hot swapping modules.	<p>When hot swapping an I/O module, it must be removed by pulling straight out from the carrier and installed by pressing straight into the carrier. Failing to do this correctly may cause error conditions or inaccurate data.</p> <p>For example, if an input module that is configured for Hold Last State is removed so that the pins on the left side of the module (as viewed from the top) are pulled out first, the data read may be erroneously read as zeros.</p> <p>Likewise, if an analog module with jumper settings for Default is inserted with the pins on the left side of the module going in last, the PNS may recognize it as Hold Last State and generate a System Mismatch error when the module is fully inserted.</p>
PNS reset causes loss of previously configured ALG260 and ALG230 Analog Input modules that are located after Power Supply Booster.	<p>If an ALG230 or ALG260 (version D or later) module is located to the right of a Power Supply Booster and configured by the PNS, when the PNS is power cycled or reset while the Booster power is maintained, the module will be lost and a Loss of I/O Module fault will be logged in the I/O Fault Table.</p> <p>This problem does not happen if the Power Supply Booster is power cycled. If the ALG230/ALG260 has not been configured, power cycling the PNS does not prevent the configuration of the analog module.</p>
PNS does not generate an alarm when MRP domain name is mismatched.	<p>When the PNS is configured as a Client to a third-party Media Redundancy Manager and the domain names do not match, the PNS does not report an alarm.</p>

GFK-2574A

Subject	Description
IC200CMM020 generates Receive Overrun errors at 19.2K Baud.	In systems with an IC200CMM020 configured to operate at 19.2K Baud, long messages may cause the IC200CMM020 to drop received characters and log a 0x0304 - Receive Overrun error. This is a rarely occurring problem, most likely to be seen in systems with only one or a few modules in the PNS stick. The recommended action if an 0x0304 error occurs is to retry the Modbus command.
PNS rejects setting its subnet mask & gateway to 0.0.0.0	The PNS does not support a subnet mask of 0.0.0.0. When a hardware configuration with LAN subnet mask address set to 0.0.0.0 is downloaded to the RX3i system, the PNS will fail to connect to the PNC.
Loss of power to PNS causes multiple fault messages.	When the PNS experiences a simultaneous loss of main and field power, the I/O Fault table may include multiple Loss of I/O Module and Channel Diagnosis Power Supply faults in addition to the Loss of Device fault.
After power cycling the PNS, several times, an RTU Preset command to a CMM020 might fail.	When using an IC200CMM020 in a PNS device, power cycling the PNS several times, then sending a Modbus RTU Preset command to the CMM020 might cause the CMM020 to fail and return an 0x0205 RTU response timeout error. To recover from this error, retry the Modbus command.
An intelligent module might not be recognized by the RX3i PNC if powered up within a specific interval.	When an intelligent module is powered up within a brief interval after the AR connection is established between the RX3i PNC and PNS, the PNC might not recognize the addition of this module. When happens, an <i>Unexpected PROFINET alarm</i> fault is logged in the IO Fault table, followed by a <i>Loss of I/O module</i> to indicate this module is not recognized. This is a rarely occurring problem, most likely seen when working with the IC200BEM003 module. To recover from this state, one of the following methods can be used: <ol style="list-style-type: none"> 1. Reset the intelligent module (pull and plug the module, or power cycle the power booster when the module is powered by a power booster). 2. Put the PNS into maintenance mode, then exit to normal mode. 3. Pull the Ethernet cable on the PNS, then plug the cable back in. 4. Power cycle the PNS unit.

Operational Notes

Subject	Description
Ethernet port operation	The PROFINET Scanner requires at least one network to be operating at full duplex for a connection to remain established. The PROFINET protocol may be sent and received over either or both of the two external ports. Devices connected to the PROFINET Scanner ports should have Ethernet Autonegotiation enabled unless the IO-Controller supports configuring the port operation mode. If the IO-Controller configures the PROFINET Scanner port to a specific setting with autonegotiation disabled, the device connected to the PROFINET Scanner must be configured for exactly the same setting.
Analog Modules latch outputs in Hold Last State	VersaMax Analog modules latch their last outputs when configured for Hold Last State and hold that value as long as Field Power remains on the module. In contrast, VersaMax Discrete modules transition to module defaults of zero even when Hold Last State is configured when they lose connection to the head-end module.
Configured output defaults active until first good data	Output modules on a PNS power up into module defaults which are typically zero. When a configuration is stored on the first connection, outputs transition to the configured defaults which may be zero, non-zero, or Hold Last State. Outputs remain at the configured defaults until output data is received from the IO-Controller. For example, if a discrete module is configured for a default value of 1 and there is a current value of 0 in the CPU, on power up, the output will be zero, then transition to 1 and then return to 0 once the output data is received.

Subject	Description
USB port drivers	When connecting the USB cable to the PROFINET Scanner, you may receive a warning for installing a driver that has not passed Windows Logo testing. Each PROFINET Scanner is recognized as a separate Windows device with separate installation as each has a unique serial number. This is normal operation for this release.
Network parameters for IO-Devices	If the network parameters (IP Address, subnet mask, and gateway IP) assigned by the DCP tool are different from the configuration in the IO-Controller and the IO-Controller is configured to assign IP settings to devices, when the IO Controller assigns its IP settings, the settings previously stored from the DCP tool are lost. On a reset, the IO-Device is set to factory default values (0.0.0.0/0.0.0.0/0.0.0.0) as prescribed by the PROFINET specification.
Communications Carrier does not support hot swap	Modules which use the Communications Carrier, IC200CHS006, do not support hot swap.
No Extra Module Alarms	The PROFINET Scanner ignores all extra equipment. There are no Extra I/O Module faults or Loss of I/O Module faults generated for unconfigured modules.
Module Jumpers latched	Jumper settings on Analog modules for selection of Default/Hold-Last-State on outputs or operational mode (Unipolar/Bipolar voltage, 0-20mA/4-20mA) are read when the module is initialized by the head-end and latched. In order to adjust a jumper setting, the I/O module must be power cycled.
Diagnosis Disappears alarms may be out of sequence with Diagnosis Appears alarms	For Intelligent Modules (IC200ALG240/ALG331/ALG620/ALG630/MDD841), Diagnosis Disappears alarms are generated by a polling process which may be slower than Appears messages. Example: When re-applying field power, new channel alarms such as Hi/Low alarms may occur before the Loss of Field Power alarm clears.
Isolated power supplies should not be mixed with non-isolated power supplies	If an isolated power supply is applied to a power slot on PNS or a booster carrier, all power supplies in that stick should be isolated power supplies. There is no restriction on mixing non-isolated AC with non-isolated DC power supplies on either the PNS or a booster.