

SPAM 150 C

Motor protection relay

User's manual and Technical description

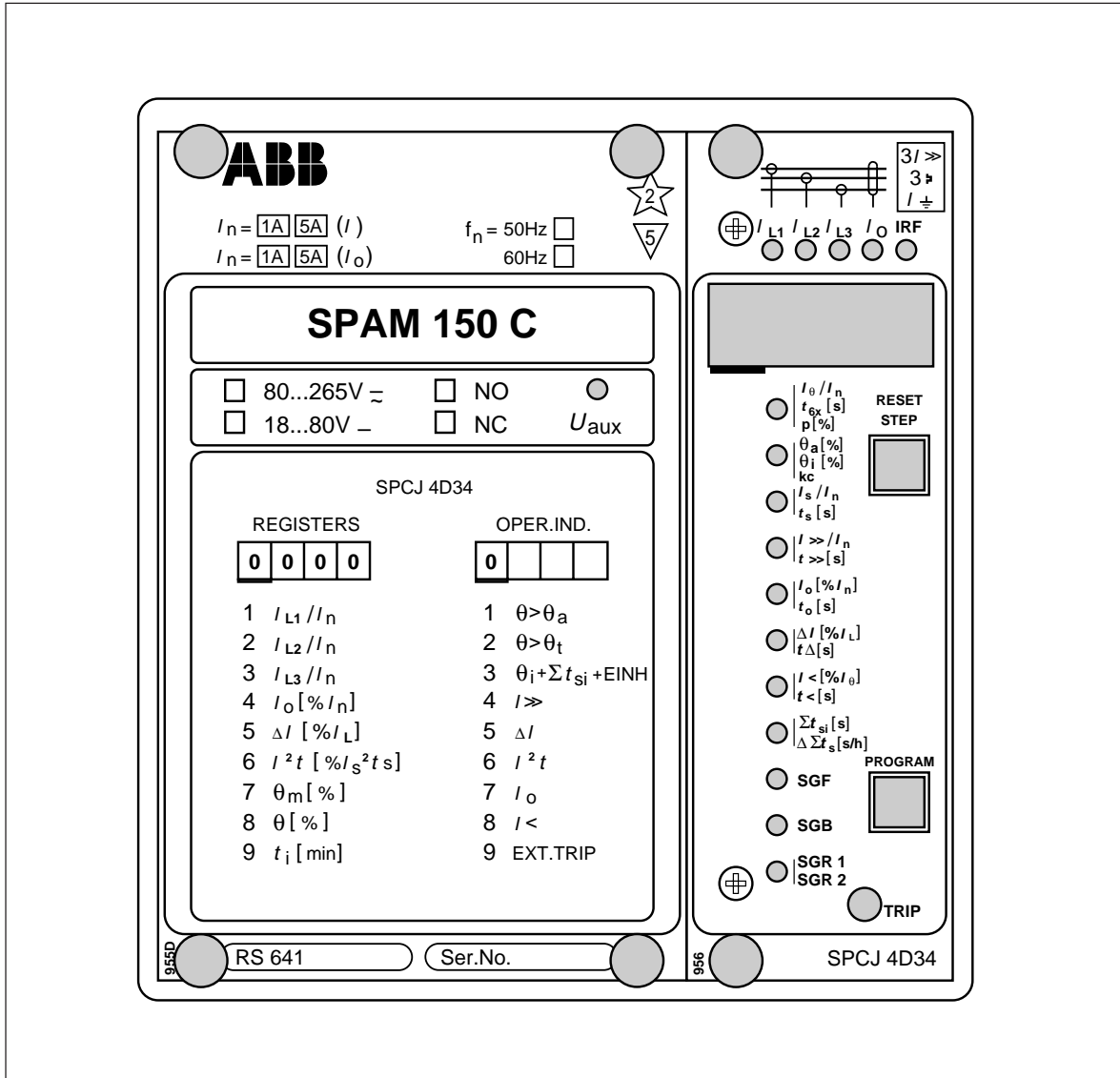

SPAM 150 C

Motor protection relay

Data subject to change without notice

Contents	Characteristics	2
	Area of application	3
	Short description of operation	3
	Connection diagram	4
	Connections	6
	Control signals between the modules	7
	Abbreviations of signal names	7
	Operation indicators	8
	Power supply and output relay module	9
	Technical data (<i>modified 2002-04</i>)	10
	Maintenance and repair	13
	Spare parts	13
	Ordering numbers	13
	Dimensions and instructions for mounting	14
	Information required with order	14

The complete user's manual includes the following separate manuals:

Motor protection relay, general description	1MRS 750637-MUM EN
General characteristics of D type relay modules	1MRS 750066-MUM EN
Motor protection relay module type SPCJ 4D34	1MRS 750476-MUM EN

Characteristics	Versatile multifunction relay for the protection of circuit breaker or contactor controlled a.c. motors	Undercurrent protection with wide start current and operate time setting ranges
	Flexible single, two or three phase protection relay for feeders etc.	Start-up supervision with $I_s^2 \times t_s$ -characteristic, with a low-set overcurrent unit or as a start-up time counter. The start-up supervision can also cooperate with a speed switch on the motor shaft of an ExE-type motor
	Thermal overload protection, monitoring all three phases, the thermal replica is adjustable both for protected objects with or protected objects without hot-spots	Continuous self-supervision of hardware and software
	High-set overcurrent protection operating instantaneously or with definite time characteristic	Current range handled meets the requirements for ExE motor drives of Zone 1
	Phase unbalance & single-phasing protection with inverse time characteristic	Two versions; one with a normally open trip contact for circuit-breaker controlled drives and another with a normally closed trip contact for contactor controlled drives
	Fast operating incorrect phase sequence protection	Fibre-optic serial communication over the SPA bus provides access to any relay data
	Sensitive definite time or instantaneous earth-fault protection with tripping or only signalling function	Powerful support software for parametrization of the relay and for recording of measured and recorded values, events, etc.

Area of application

The microprocessor based motor protection relay SPAM 150 C is an integrated design current measuring multifunction relay for the complete protection of a.c. motors. The main area of application covers large or medium-sized three-phase motors in all types of conventional contactor or circuit breaker controlled motor drives. The motor protection relay is available in

two versions, one with a making trip contact and the other with a breaking trip contact.

The relay can also be used in other applications requiring a single-, two- or three-phase over-current and/or overload protection and non-directional earth-fault protection.

Short description of operation

The combined multifunction motor protection relay is a secondary relay device which is connected to the current transformers of the protected motor drive. The three phase currents and the neutral current of the protected device are continuously measured and on the basis of this measurement, the thermal condition of the motor is calculated and the faults of the network are detected. In fault situations the protective units of the relay provide alarm or trip the circuit-breaker.

By appropriate programming of the output relay matrix, various starting, prior alarm or restart inhibit signals are received as contact functions. This contact information is used e.g.

for the blocking of co-operating protective relays located upstreams, for connection to annunciator units etc.

The motor protection relay contains one external logic control input, which is activated by a control signal on the auxiliary voltage level. The influence of the control input on the relay is determined by programming switches of the measuring module. The control input can be used either for blocking one or more of the protective stages, for carrying out an external trip order, for inhibiting a restart attempt or for resetting a latched output relay in the manual reset mode.

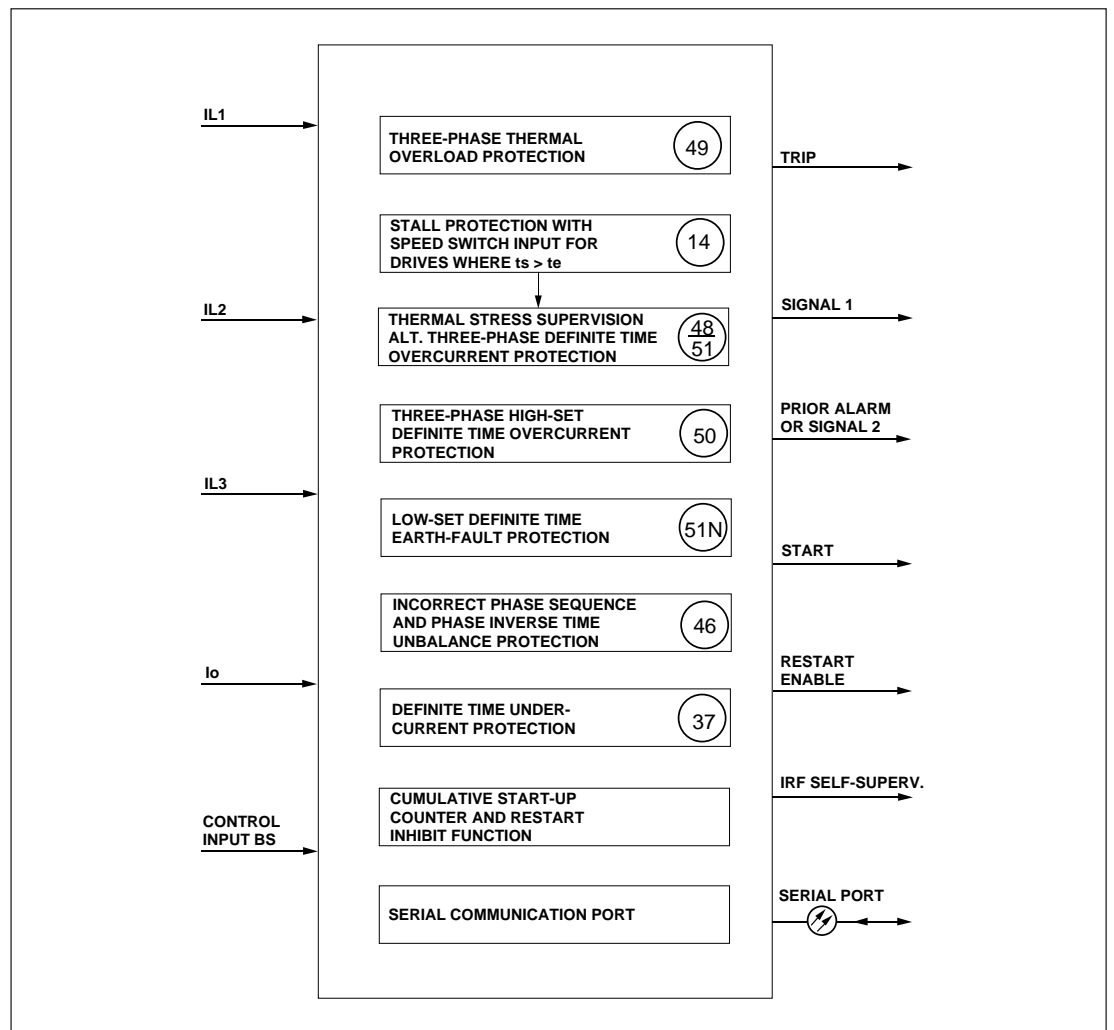

Fig. 1. Protective functions of the motor protection relay type SPAM 150 C. The encircled numbers refer to the ANSI-numbering of protective functions.

Connection diagram

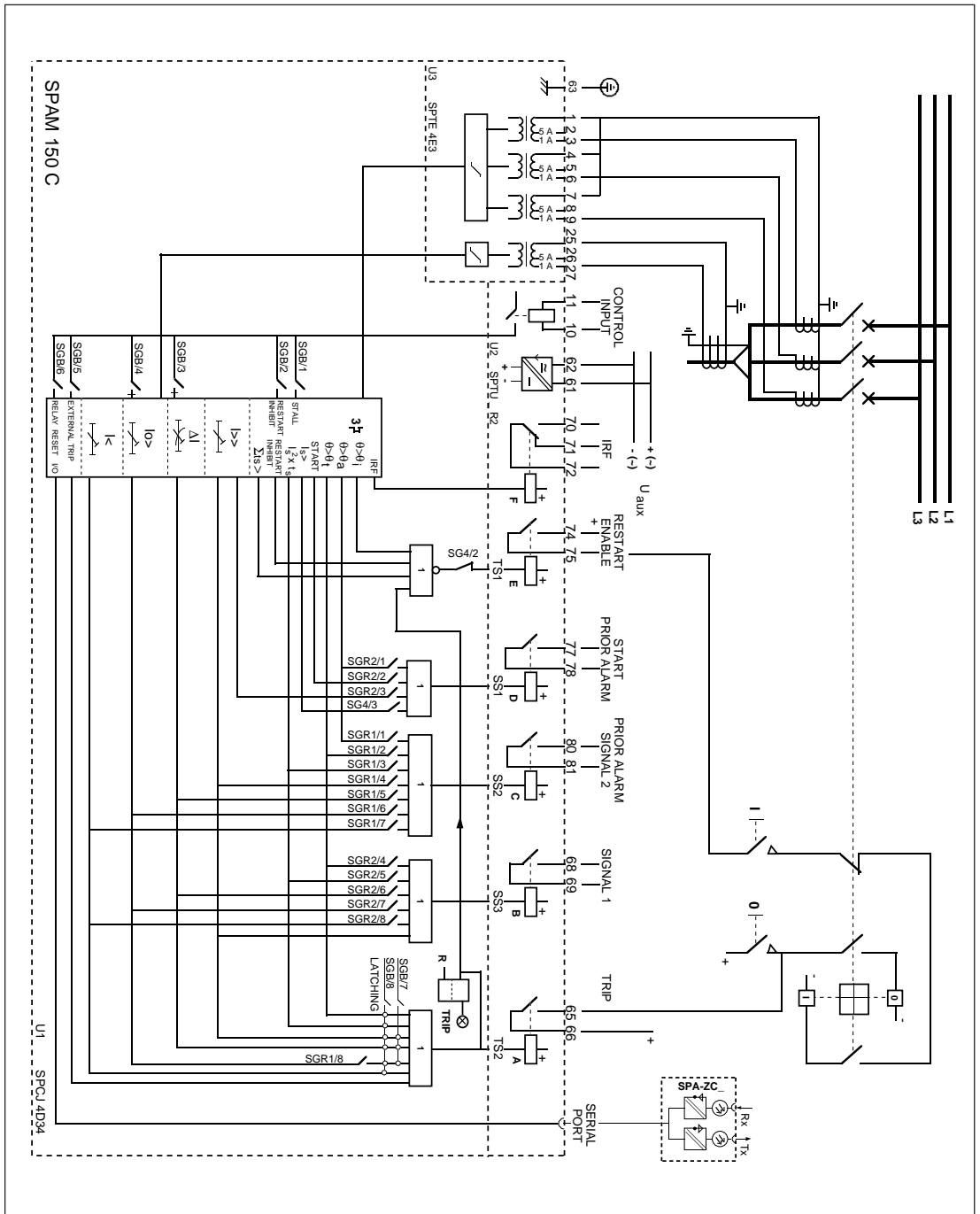

Fig. 2. Connection diagram of the motor protection relay SPAM 150 C. The version shown is the one with the normally open trip contact, i.e. with an auxiliary supply and output relay module type SPTU 240R2 or SPTU 48R2.

U_{aux}	Auxiliary voltage
A, B, C, D, E, F	Output relays
IRF	Self-supervision
SGB	Switchgroup for the configuration of the blocking or control signal
TRIP	Trip output relay, output 65-66
SIGNAL	Signal on tripping
PRIOR ALARM	Prewarning for a beginning overload condition
START	Start information from the motor
RESTART ENABLE	Starting of motor inhibited in fault conditions
U1	Motor protection module SPCJ 4D34
U2	Power supply and output relay module SPTU 240 R2 or SPTU 48 R2 with a normally open trip contact, SPTU 240 R3 or SPTU 48 R3 with a normally closed trip contact
U3	Input module SPTE 4E3
SPA-ZC—	Bus connection module
SERIAL PORT	Serial communication port
Rx, Tx	Receiver bus terminal (Rx) and the transmitter bus terminal (Tx) of the bus connection module
STALL	External stall control input
RESTART INHIBIT	External restart inhibit control signal
LATCHING	Latching function of the trip relay

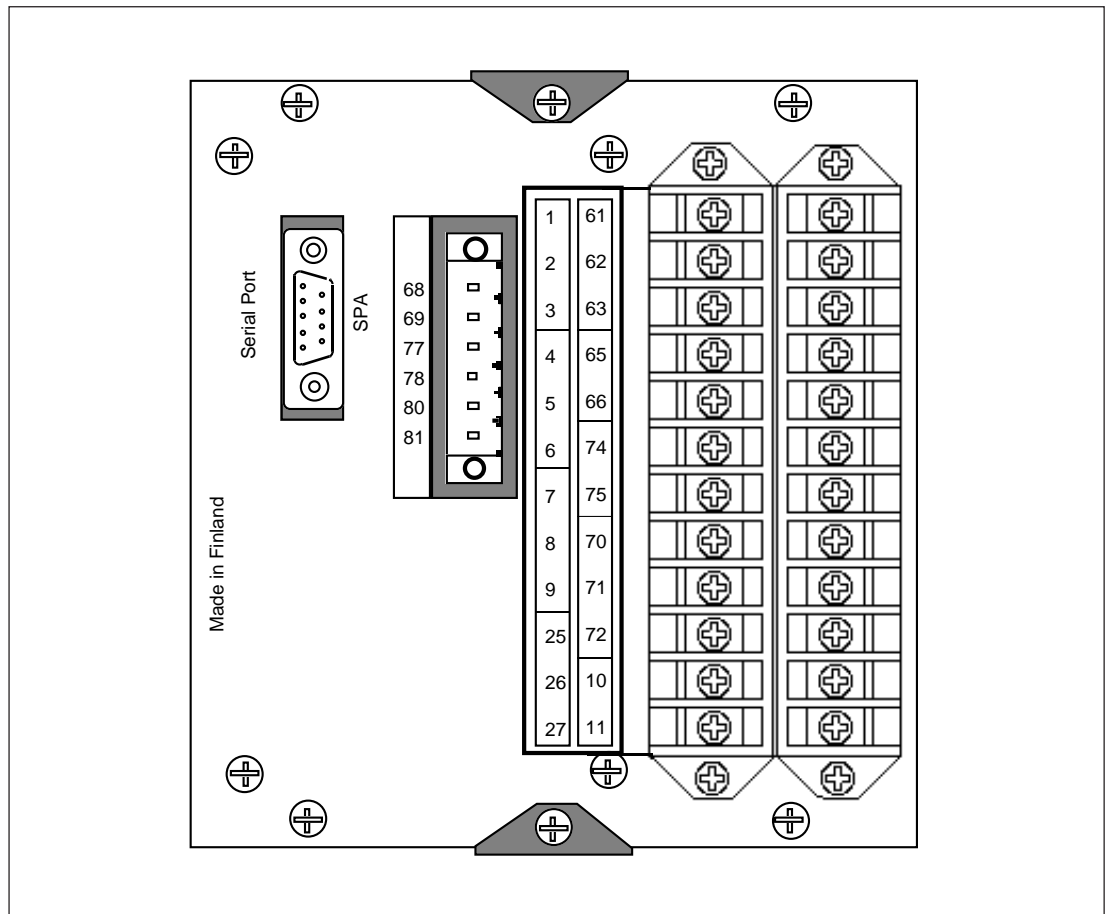

Fig. 3. Rear view of relay SPAM 150 C.

Connections

The three phase currents are connected to terminals 1-2, 4-5 and 7-8, when the rated current of the secondary circuits is $I_n = 5$ A. When using current transformers with a rated current of 1 A, terminals 1-3, 4-6 and 7-9 are used. The thermal overload protection may also be used in single-phase or two-phase applications, in this case inputs not used may be left unconnected.

To get a proper operation of the unbalance and incorrect phase sequence protection in a two-phase application, the two phase currents should be summed in the third phase current input. In single-phase applications, wiring the phase current through two or three current inputs in series may slightly increase the operating speed of the relay and stabilize operation of the thermal unit.

The neutral current of the earth-fault protection is connected to terminals 25-26 when the rated current is 5 A and to terminals 25-27 when the rated current is 1 A.

The control input 10-11 can be used in five different ways:

- as the control input controlled by a motor speed switch in Ex-type applications
- as the control input of an external blocking signal for blocking the operation of the unbalance or earth-fault protection units
- as the control input for an external trip signal
- as the control input for unlatching the trip relay
- as the control input for the restart enable relay.

The designed function is selected by means of switches 1...8 of switchgroup SGB in the main menu of the protection relay module.

The auxiliary supply voltage of the relay is connected to the terminals 61-62. At d.c. auxiliary supply voltage the positive lead is connected to terminal 61. The accepted input voltage range is determined by the type of power supply and output relay module inserted in the relay case. For further details see the description of the power supply module. The accepted auxiliary voltage range of the relay is indicated on the front panel.

Output relay A provides the CB tripping commands when the operate time of a protective unit has elapsed. The earth-fault unit can be made non-tripping, i.e. only signalling, with switch 8 of switchgroup SGR1. On delivery from factory all protective units are selected to perform tripping. A latching function of the output relay A can be selected by means of switches SGB/7 and SGB/8. Switch SGB/7 gives a latching function after a short-circuit, an earth-fault or an unbalance tripping. Switch SGB/8 pro-

vides a latching function after any trip operation. After having latched the output relay must be manually reset or reset by remote control.

The trip alarm signals from the relay module are obtained via output relays B and C. The signals to be routed to these relays are selected with switches 1...7 of switchgroup SGR1 and switches 4...8 of switchgroup SGR2 of the relay module. Normally the output relays B and C are given such a configuration that a thermal prior alarm is obtained over relay C and the trip signals of the protection units are linked to output relay B to form an auxiliary trip signal. This is also the default setting of the relay on delivery from the factory.

The signals to be routed to the output relay D are selected with switches 1, 2 and 3 of software switchgroup SGR2 in the main menu of the relay module. Switch SGR2/1 routes the thermal prior alarm, switch SGR2/2 routes the startup information for the motor and switch SGR2/3 routes the start signal of the high-set overcurrent stage to output relay D.

Output relay E, terminals 74-75, is a heavy duty output relay capable of controlling a circuit breaker, as the main trip relay A. Relay E is used for controlling the restart of the motor. If the thermal capacity used exceeds the set restart inhibit level of the thermal unit, if the allowed maximum cumulative start-up count is exceeded or if the external restart inhibit signal is active the output relay E prevents a motor restart attempt. This also applies to a condition where the protective relay is out of auxiliary voltage or the relay is faulty.

Output relay F, terminals 70-71-72, operates as the output relay of the integrated self-supervision system. The relay operates on the closed-circuit principle, thus under normal service conditions the contact gap 70-72 is closed. If a fault is detected by the self-supervision system, or if the auxiliary supply fails, the output relay drops off, providing an alarm signal by closing the NO contact 71-72.

The relay is connected to the SPA data bus by means of bus connection module type SPA-ZC 17 or SPA-ZC21. The bus connection module is connected to the D type connector marked SERIAL PORT on the rear panel of the relay. The fibre-optic cables are connected to the connectors Tx and Rx of the bus connection module. The communication mode selector switches on the bus connection module are set in position "SPA".

Control signals between the modules

The figure below schematically illustrates how the starting, tripping, control and blocking sig-

nals can be programmed to obtain the required function of the protection relay.

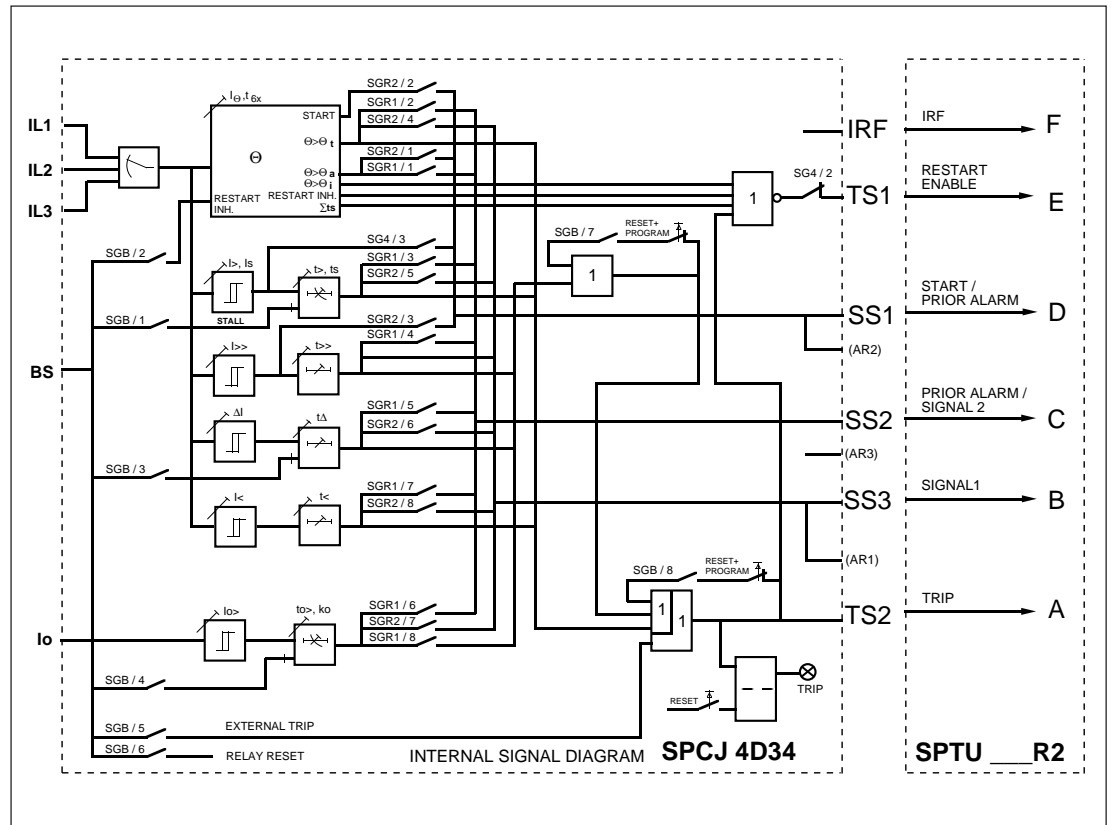

Fig. 4. Control signals between the modules of the motor protection relay SPAM 150 C.

The functions of the blocking and starting signals are selected with the switches of switchgroups SGF, SGB and SGR. The checksums of the switchgroups are found in the setting menu of

the measuring relay module. The functions of the different switches are explained in the user's manual of the measuring module SPCJ 4D34.

Abbreviations of signal names

I_{L1}, I_{L2}, I_{L3}	Phase currents
I_0	Neutral current
BS	Blocking or control Signal
SS1	Start Signal 1
SS2	Start Signal 2
SS3	Start Signal 3
TS1	Trip Signal 1
TS2	Trip Signal 2
AR1...3	Auto-Reclose start signals (not in use in SPAM 150 C)
IRF	Internal Relay Fault signal
SGF	Switch Group for Functions
SGB	Switch Group for Blockings
SGR1...2	Switch Groups for Relay configuration

Operation indicators

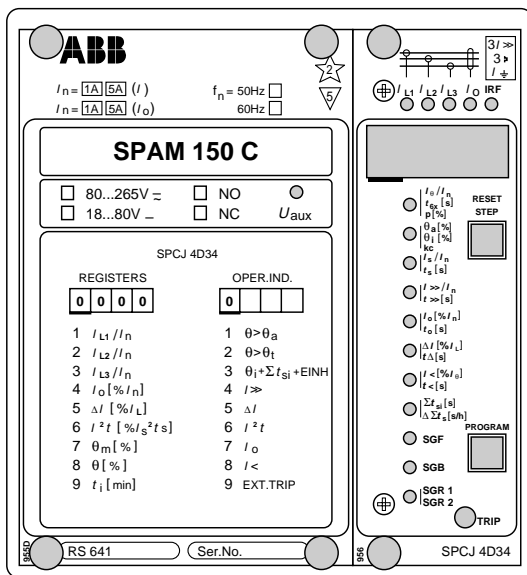

A) The operation indicator TRIP is lit when one of the protection stages operates. When the protection stage resets, the red indicator remains alight.

B) If the display is dark when one of the protection stages $I>$, $I>>$ or $I_0>$ operates, the faulty phase or the neutral path is indicated with a yellow LED. If, for instance, the TRIP indicator glows red, and the indicators I_{L1} and I_{L2} at the same time are illuminated, overcurrent has occurred on phase L1 and L2.

C) Besides being a code number at data presentation, the leftmost red digit in the display serves as a visual operation indicator. An operation indicator is recognized by the fact that the red digit alone is switched on. Normally the first event to appear is indicated. For the thermal unit, however, a prior alarm signal is later replaced by the trip indication, if tripping is carried out. In order to enable reading of actual thermal levels etc., it is possible to acknowledge the indication of the thermal unit while the unit is still activated. The same applies to a signalling earth-fault. In these cases the indications are memorized and reappear when the display is dark. All operation indicators are automatically reset when the motor is restarted. The following table, named OPERATION IND. on the relay front panel, is a key to the operation indicator code numbers used.

Indication	Explanation
1	$\theta > \theta_a$ = The thermal level has exceeded the set prior alarm level
2	$\theta > \theta_t$ = The thermal unit has tripped
3	$\theta > \theta_i, \sum t_{si},$ = The thermal restart inhibit level is exceeded, the startup time counter is full or the external inhibit signal is active
4	$I>>$ = The high-set stage of the overcurrent unit has tripped
5	ΔI = The unbalance/incorrect phase sequence protection unit has tripped
6	$I^2 \times t$ = The start-up stall protection unit has tripped
7	I_0 = The earth-fault unit has tripped
8	$I<$ = The undercurrent unit has tripped
9	EXT.TRIP = An external tripping has been carried out

D) The TRIP indications persist when the protective stage returns to normal. The indicator is reset by pushing the RESET/STEP push-button. A restart of the motor automatically resets the operation indications.

Further, the indicators may be reset via the external control input 10-11 by applying a control voltage to the input, provided that the switch SGB/6 is in position 1.

The basic protective relay functions are not depending on the state of the operation indicators, i.e. reset or non-reset. The relay is permanently operative.

E) In two minutes after the internal self-supervision system has detected a permanent relay fault the red IRF indicator is lit and the output relay of the self-supervision system operates. Further, in most fault situations an autodiagnostic fault code is shown in the display. The fault code is composed of a red figure 1 and a green code number, which indicates the fault type. The fault code can not be reset as long as the fault persists. When a fault code appears on the display, the code number should be recorded on a piece of paper and given to the authorized repair shop, when overhaul is ordered.

Power supply and output relay module

To be able to operate the relay needs a secured auxiliary voltage supply. The power supply module forms the voltages required by the measuring relay module and the auxiliary relays. The withdrawable power supply and output relay module is located behind the system front panel, which is fixed by means of four cross-slotted screws. The power supply and output relay module contains the power supply unit, all output relays, the control circuits of the output relays and the electronic circuitry of the external control inputs.

The power supply and output relay module can be withdrawn after removing the system front

panel. The primary side of the power supply module is protected with a fuse, F1, located on the PCB of the module. The fuse size is 1 A (slow).

The power supply unit is a transformer connected, i.e. galvanically isolated primary and secondary side, flyback-type dc/dc converter. It forms the dc secondary voltages required by the measuring relay module; that is +24 V, ± 12 V and +8 V. The output voltages ± 12 V and +24 V are stabilized in the power supply module, while the +5 V logic voltage required by the measuring relay module is formed by the stabilizer of the relay module.

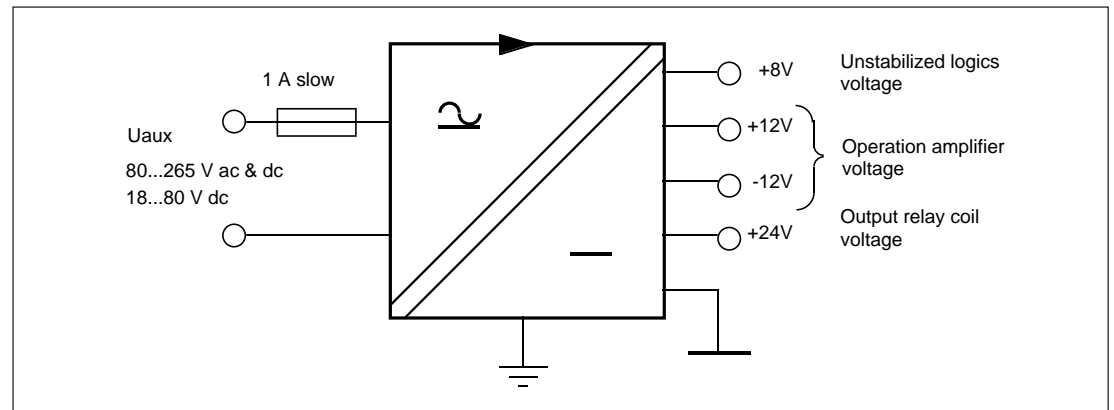

Fig. 5. Voltage levels of the power supply module.

A green LED indicator U_{aux} on the system front panel is illuminated when the power supply module is in operation. The supervision of the voltages supplying the electronics is placed in the measuring module. If a secondary voltage deviates from its rated too much, a self-supervision alarm will be established. An alarm is also established when the power supply module is withdrawn from the relay case, or when the auxiliary power supply to the relay is interrupted.

There are two versions of power supply and output relay modules available. For both types, the secondary sides and the relay configurations are identical, but the input voltage ranges differ.

Voltage ranges of the power supply modules:

- SPTU 240R2 or SPTU 240R3 $U_{aux} = 80...265$ V dc/ac
- SPTU 48R2 or SPTU 48R3 $U_{aux} = 18...80$ V dc

The modules SPTU 240 R2 or SPTU 240 R3 can be used with both ac and dc voltages. Modules SPTU 48 R2 and SPTU 48 R3 are designed for dc supply only. The auxiliary voltage range of the power supply module of the relay assembly is indicated on the system front panel.

The module SPTU 240R2 and SPTU 48R2 have a normally open trip contact whereas the modules SPTU 240R3 and SPTU 48R3 have a normally closed trip contact.

Technical data
(modified 2002-04)

Energizing inputs

Phase and neutral current inputs, terminals	1-2, 4-5, 7-8, 25-26	1-3, 4-6, 7-9, 25-27
Rated current I_n	5 A	1 A
Thermal withstand capability		
- continuously	20 A	4 A
- for 1 s	500 A	100 A
Dynamic current withstand, half-wave value	1250 A	250 A
Input impedance	< 20 m Ω	< 100 m Ω
Phase current monitoring range	0...63 x I_n	
Neutral current monitoring range	0...210 % I_n	
Rated frequency f_n	50 Hz / 60 Hz	

Output contact ratings

Trip contact and restart enable contact		
Contact type *)	NO (normally open)	NC (normally closed)
Terminals	65-66, 74-75	65-66
- Rated voltage	250 V dc/ac	250 V dc/ac
- Carry continuously	5 A	5 A
- Make and carry for 0.5 s	30 A	10 A
- Make and carry for 3.0 s	15 A	8 A
- Breaking capacity for dc, when the control circuit time-constant $L/R \leq 40$ ms, at 48 / 110 / 220 V dc	5 A / 3 A / 1 A	1 A / 0.25 A / 0.15 A
Breaking capacity for ac	5 A	5 A

Signalling contacts

Terminals	70-71-72, 68-69, 77-78, 80-81
- Rated voltage	250 V dc/ac
- Rated current	5 A
- Make and carry for 0.5 s	10 A
- Make and carry for 3.0 s	8 A
- Breaking capacity for dc, when the control circuit time-constant $L/R \leq 40$ ms, at 48 / 110 / 220 V dc control circuit voltage	1 A / 0.25 A / 0.15 A

External control inputs

Blocking, remote reset or remote setting input	10-11
External control voltage level	18...265 V dc or 80...265 V ac
Typical control current of input circuit	2...20 mA

Power supply and output relay module

Supply and relay module, type SPTU 240R2/ - R3	80...265 V dc/ac
Supply and relay module, type SPTU 48R2/ - R3	18...80 V dc
Power consumption under quiescent/operating conditions	~4 W/ ~6 W

Note!

*) The trip contact 65-66 has different contact ratings depending on whether it is a normally open contact (SPTU 240R2 or SPTU 48R2) or a normally closed contact (SPTU 240R3 or SPTU 48R3).

Motor protection relay module SPCJ 4D34

Thermal overload unit	
Setting of full load current, I_{θ}	0.5...1.50 x I_n
Resolution of current setting	0.01 x I_n
Setting of maximum stall time, $t_{\theta x}$	2.0...120 s
Resolution of stall time-setting	0.5 s
Cooling time-constant k_c at zero current (standstill)	1...64 x the heating time constant
Thermal prior alarm level θ_a , if in use	50...100% of the thermal trip level θ_t
Restart inhibit level θ_i	20...80% of the thermal trip level θ_t
Thermal unit initialization after an auxiliary supply interrupt *)	70% of the thermal trip level θ_t , i.e. hot motor
Low-set overcurrent unit **)	
Setting range for $I_{>}$	1.0...10.0 x I_n
Operate time $t_{>}$	0.3...80 s
Current based start-up supervision **)	
Startup current setting range I_s	1.0...10.0 x I_n
Startup time setting range t_s	0.3...80 s
Shortest operate time	~300 ms
High-set overcurrent unit	
Setting range for $I_{>>}$	0.5...20.0 x I_n and ∞ , infinite
Operate time $t_{>>}$	0.04...30 s
Earth-fault protection unit	
Setting range for I_0	1.0...100% I_n
Operate time t_0	0.05...30 s
Attenuation of the third harmonic, typ.	-20 dB
Phase unbalance unit	
Basic sensitivity ΔI , stabilized to phase current levels below I_{θ}	10...40% x I_L and ∞ , infinite
Operate time at lowest settable pick-up level, 10 %	20...120 s, inverse time
Operate time at full unbalance (single phasing)	1 s
Operate time incorrect phase sequence protection	600 ms
Undercurrent unit	
Start current $I_{<}$ in per cent of the full load current setting	30...80% I_{θ} or out of operation
Operation inhibited below level	12% I_{θ}
Operate time	2...600 s
Time-based start inhibit counter	
Setting range $\sum t_{si}$	5...500 s
Countdown rate of start time counter $\Delta t_s / \Delta t$	2...250 s / h

Note!

*) If the thermal prior alarm is set below 70%, the connection of the auxiliary supply to the relay will cause a thermal prior alarm signal.

**) The operation can be defined either as a low-set definite time overcurrent function (SGF/7 = 0) or as a current based start-up supervision function (SGF/7=1). Both functions cannot be used at the same time. In either case, the time-counting can be stopped by a control signal to the speed switch input (SGB/1 =1).

Data transmission

Transmission mode	Fibre optic serial bus
Data code	ASCII
Selectable data transfer rates	4800 or 9600 Bd

Fibre optic bus connection module
for supply from host relay

- for plastic core cables	SPA-ZC 21 BB
- for glass fibre cables	SPA-ZC 21 MM

Fibre optic bus connection module for
supply from separate power source

- for plastic core cables	SPA-ZC 17 BB
- for glass fibre cables	SPA-ZC 17 MM

Insulation Tests *)

Dielectric test IEC 60255-5	2 kV, 50 Hz, 1 min
Impulse voltage test IEC 60255-5	5 kV, 1.2/50 μ s, 0.5 J
Insulation resistance measurement IEC 60255-5	>100 M Ω , 500 Vdc

Electromagnetic Compatibility Tests *)

High-frequency (1 MHz) burst disturbance test
IEC 60255-22-1

- common mode	2.5 kV
- differential mode	1.0 kV

Electrostatic discharge test IEC 60255-22-2 and
IEC 61000-4-2

- contact discharge	6 kV
- air discharge	8 kV

Fast transient disturbance test IEC 60255-22-4
and IEC 61000-4-4

- power supply	4 kV
- I/O ports	2 kV

Mechanical tests (tested with SPAJ 140 C)

Seismic tests acc. to ANSI/IEEE C37.98-1987

- operating basis earth-quake tests (OBE)	0.5...5.25 g
- safe shut-down earth-quake tests (SSE)	0.5...7.5 g
Vibration test	2...13.2 Hz, \pm 1.0 mm
	13.2...100 Hz, \pm 0.7 g
Shock/bump test acc. to IEC 60255-21-2	20 g, 1000 bumps/direction

Environmental conditions

Corrosion test	Battelle-test
Specified ambient service temperature range	-10...+55°C
Long term damp heat withstand according to IEC 60068-2-3	<95% at 40°C for 56 d
Transport and storage temperature range	-40...+70°C
Protection by enclosure according to IEC 60529, when the relay is panel mounted	IP 54
Mass of the relay including flush mounting relay case	~3.5 kg

*) The tests do not apply to the serial port, which is used exclusively for the bus connection module.

Maintenance and repair

When the protective relay is operating under the conditions specified in the section "Technical data", the relay is practically maintenance-free. The relay modules include no parts or components subject to an abnormal physical or electrical wear under normal operating conditions.

If the environmental conditions at the relay operating site differ from those specified, as to temperature, humidity, or if the atmosphere around the relay contains chemically active gases or dust, the relay ought to be visually inspected in association with the relay secondary test or whenever the relay modules are withdrawn from the case. At the visual inspection the following things should be noted:

- Signs of mechanical damage on relay modules, contacts and relay case
- Accumulation of dust inside the relay cover or case; remove by blowing air carefully
- Rust spots or signs of erugo on terminals, case or inside the relay

On request, the relay can be given a special treatment for the protection of the printed circuit boards against stress on materials, caused by abnormal environmental conditions.

If the relay fails in operation or if the operating values remarkably differ from those of the relay specifications, the relay should be given a proper overhaul. Minor measures can be taken by personnel from the instrument workshop of the customer's company, e.g. replacement of auxiliary relay modules. All major measures involving overhaul of the electronics are to be taken by the manufacturer. Please contact the manufacturer or his nearest representative for further information about checking, overhaul and recalibration of the relay.

Note!

Numerical protection relays contain electronic circuits which are liable to serious damage due to electrostatic discharge. Before removing a module containing electronic circuits, ensure that you are at the same electrostatic potential as the equipment, for instance, by touching the relay case.

Note!

Static protective relays are measuring instruments and should be handled with care and protected against moisture and mechanical stress, especially during transport.

Spare parts

Motor protection relay module	SPCJ 4D34
Power supply and output relay module	
$U_{aux} = 80...265 \text{ V ac/dc}$	SPTU 240R2 for NO trip contact
$U_{aux} = 18...80 \text{ V dc}$	SPTU 48R2 for NO trip contact
$U_{aux} = 80...265 \text{ V ac/dc}$	SPTU 240R3 for NC trip contact
$U_{aux} = 18...80 \text{ V dc}$	SPTU 48R3 for NC trip contact
Relay box, complete with input module	SPTK 4E3
Input module as separate part	SPTE 4E3
Bus connection module	SPA-ZC 17 or SPA-ZC 21

Ordering numbers

Motor protection relay with make type tripping contact
SPAM 150 C RS 641 014 - AA, CA, DA, FA

Motor protection relay with break type tripping contact
SPAM 150 C RS 641 015 - AB, CB, DB, FB

The last letters of the ordering number indicate the rated frequency f_n and the auxiliary voltage range U_{aux} of the relay as follows:

AA or AB equals $f_n = 50\text{Hz}$ and $U_{aux} = 80...265 \text{ V ac/dc}$

CA or CB equals $f_n = 50\text{Hz}$ and $U_{aux} = 18...80 \text{ V dc}$

DA or DB equals $f_n = 60\text{Hz}$ and $U_{aux} = 80...265 \text{ V ac/dc}$

FA or FB equals $f_n = 60\text{Hz}$ and $U_{aux} = 18...80 \text{ V dc}$

Power supply and output relay modules with make type tripping contact

SPTU 240R2 RS 941 021 - AA

SPTU 48R2 RS 941 021 - BA

Power supply and output relay modules with break type tripping contact

SPTU 240R3 RS 941 022 - AA

SPTU 48R3 RS 941 022 - BA

Dimensions and instructions for mounting

The relay is housed in a normally flush-mounted case. The relay can also be arranged for semi-flush mounting with the use of a 40 mm, 80 mm or 120 mm raising frame, which reduces the depth behind the panel by the same dimension. The type designations of the raising frames are SPA-ZX 111 for the 40 mm, SPA-ZX 112 for the 80 mm and SPA-ZX 113 for the 120 mm frame. A surface mounting case SPA - ZX 110 is also available.

The relay case is made of profile aluminium and finished in beige.

A cast aluminium alloy mounting frame with a rubber gasket provides a degree of protection by enclosure to IP 54 between the relay case and the panel surface when the relay is panel mounted.

The relay case is complete with a hinged gasketed, clear, UV-stabilized polycarbonate cover with a sealable fastening screw. The degree of protection by enclosure of the cover is also IP 54.

A terminal strip and two multipole connectors are mounted on the back of the relay case to facilitate all input and output connections. To each heavy duty terminal, i.e. the measuring input, the power supply input or the trip output, one 6 mm² or one or two 2.5 mm² wires can be connected. No terminal lugs are needed. The signalling outputs are available on a six pole detachable connector and the serial bus connects a 9-pin D-type connector.

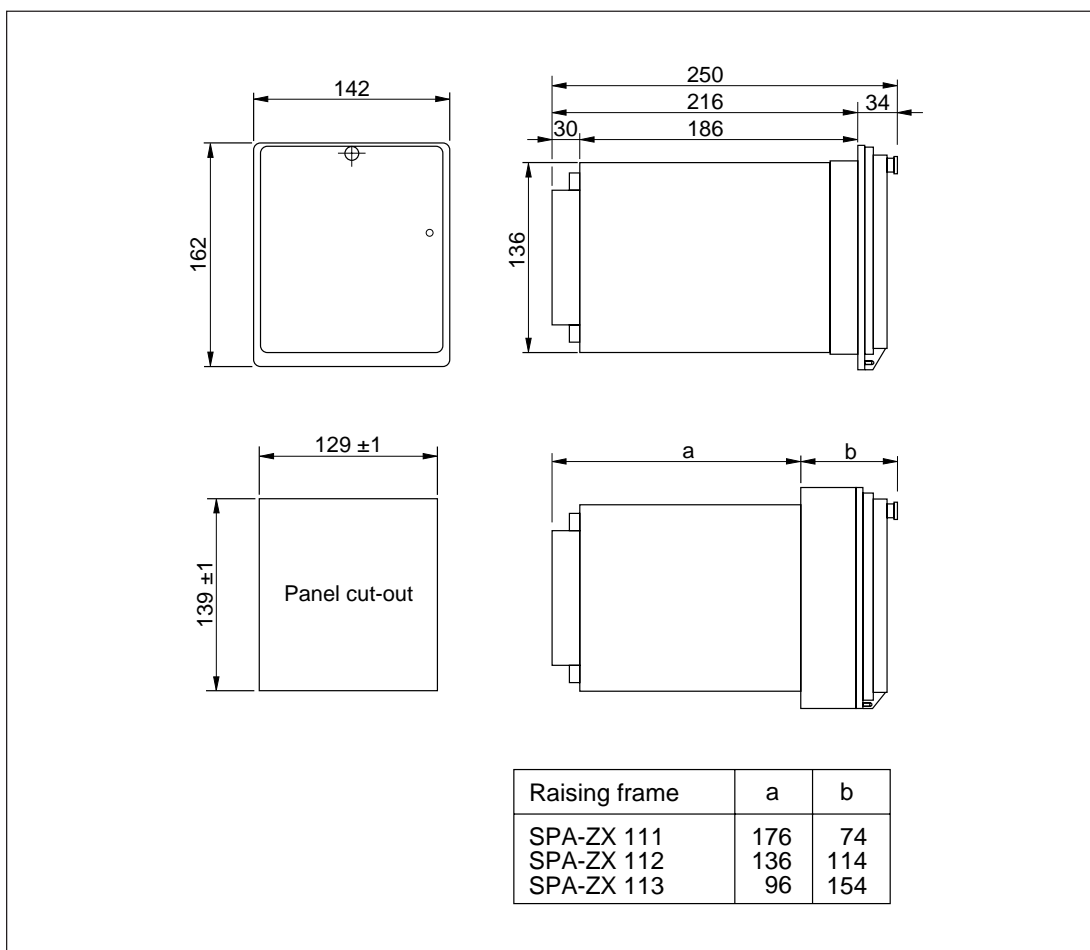

Information required with order

1. Quantity and type designation
2. Ordering number
3. Trip contact N.O. or N.C.
4. Rated frequency
5. Auxiliary voltage
6. Accessories

7. Special requirements

Example

15 pcs SPAM 150 C
 RS 641 014 - AA
 Normally open
 $f_n = 50$ Hz
 $U_{aux} = 110$ V dc
 15 pcs bus interface modules SPA-ZC21 MM
 2 pcs fibre optical cables SPA-ZF MM 100
 14 pcs fibre optical cables SPA-ZF MM 5

General characteristics of D-type relay modules

User's manual and Technical description

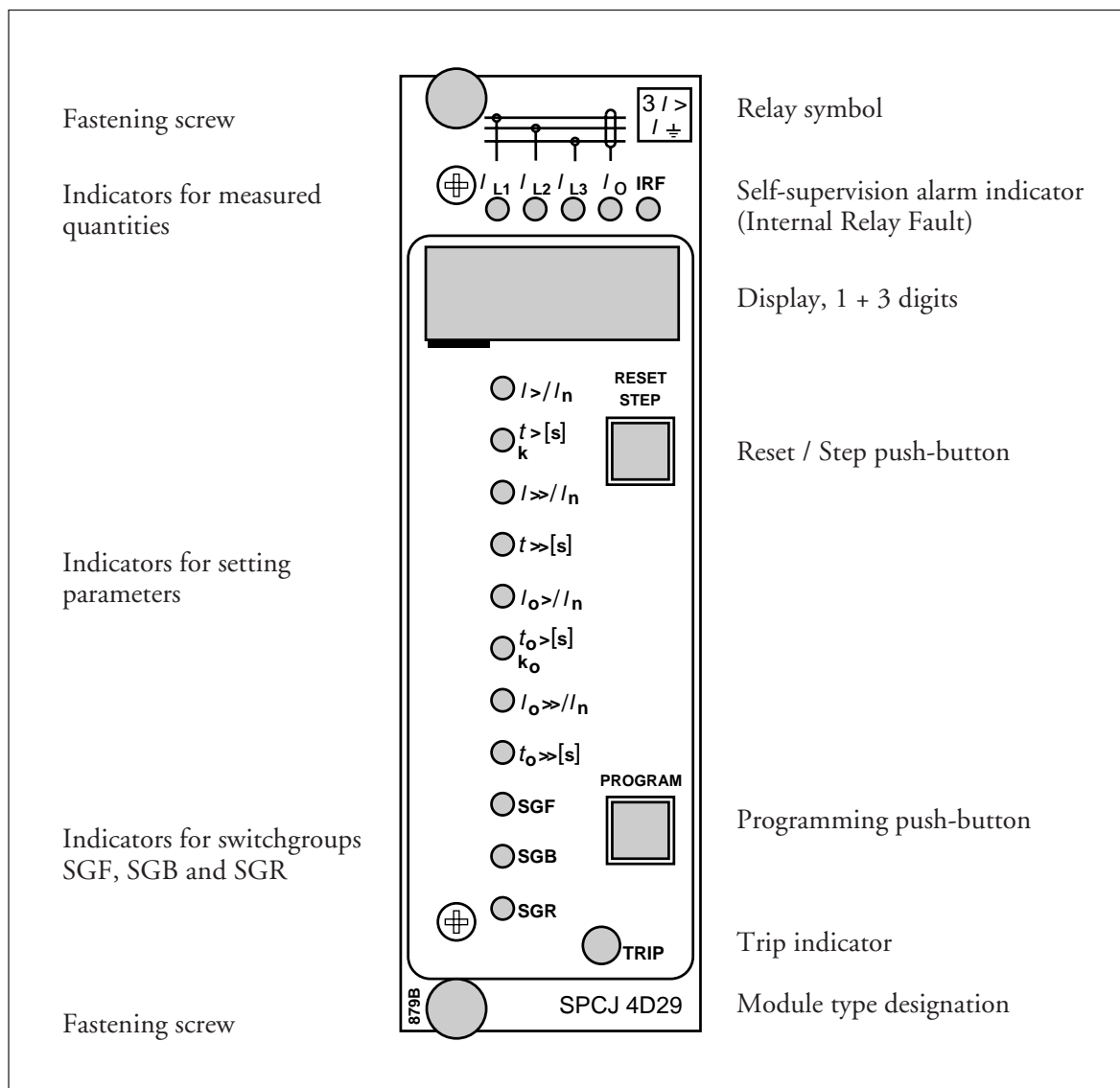

General characteristics of D type relay modules

Data subject to change without notice

Contents

Front panel lay-out	1
Control push buttons	3
Display	3
Display main menu	3
Display submenus	3
Selector switchgroups SGF, SGB, SGR	4
Settings	4
Setting mode	4
Example 1: Setting of relay operation values	7
Example 2: Setting of relay switchgroups	9
Recorded information	11
Trip test function	12
Example 3: Forced activation of outputs	13
Operation indicators	15
Fault codes	15

Control push-buttons	The front panel of the relay module contains two push buttons. The RESET / STEP push button is used for resetting operation indicators and for stepping forward or backward in the display main menu or submenus. The PROGRAM push button is used for moving from a	certain position in the main menu to the corresponding submenu, for entering the setting mode of a certain parameter and together with the STEP push button for storing the set values. The different operations are described in the subsequent paragraphs in this manual.
Display	The measured and set values and the recorded data are shown on the display of the protection relay module. The display consists of four digits. The three green digits to the right show the measured, set or recorded value and the leftmost red digit shows the code number of the register. The measured or set value displayed is indicated by the adjacent yellow LED indicator on the front panel. When a recorded fault value is being displayed the red digit shows the number of the corresponding register. When the display functions as an operation indicator the red digit alone is shown.	When the auxiliary voltage of a protection relay module is switched on the module initially tests the display by stepping through all the segments of the display for about 15 seconds. At first the corresponding segments of all digits are lit one by one clockwise, including the decimal points. Then the center segment of each digit is lit one by one. The complete sequence is carried out twice. When the test is finished the display turns dark. The testing can be interrupted by pressing the STEP push button. The protection functions of the relay module are alerted throughout the testing.
Display main menu	<p>Any data required during normal operation are accessible in the main menu i.e. present measured values, present setting values and recorded parameter values.</p> <p>The data to be shown in the main menu are sequentially called up for display by means of the STEP push button. When the STEP push button is pressed for about one second, the display moves forward in the display sequence. When the push button is pressed for about 0.5 seconds, the display moves backward in the display sequence.</p>	<p>From a dark display only forward movement is possible. When the STEP push button is pushed constantly, the display continuously moves forward stopping for a while in the dark position.</p> <p>Unless the display is switched off by stepping to the dark point, it remains lit for about 5 minutes from the moment the STEP push button was last pushed. After the 5 minutes' time-out the display is switched off.</p>
Display submenus	<p>Less important values and values not very often set are displayed in the submenus. The number of submenus varies with different relay module types. The submenus are presented in the description of the concerned protection relay module.</p> <p>A submenu is entered from the main menu by pressing the PROGRAM push button for about one second. When the push button is released, the red digit of the display starts flashing, indicating that a submenu has been entered. Going from one submenu to another or back to the main menu follows the same principle as when moving from the main menu display to another;</p>	<p>the display moves forward when the STEP push button is pushed for one second and backward when it is pushed for 0.5 seconds. The main menu has been re-entered when the red display turns dark.</p> <p>When a submenu is entered from a main menu of a measured or set value indicated by a LED indicator, the indicator remains lit and the address window of the display starts flashing. A submenu position is indicated by a flashing red address number alone on the display without any lit set value LED indicator on the front panel.</p>

Selector switch-groups SGF, SGB and SGR

Part of the settings and the selections of the operation characteristic of the relay modules in various applications are made with the selector switchgroups SG_. The switchgroups are software based and thus not physically to be found in the hardware of the relay module. The indicator of the switchgroup is lit when the checksum of the switchgroup is shown on the display. Starting from the displayed checksum and by entering the setting mode, the switches can be set one by one as if they were real physical switches. At the end of the setting procedure, a checksum for the whole switchgroup is shown. The checksum can be used for verifying that the switches have been properly set. Fig. 2 shows an example of a manual checksum calculation.

When the checksum calculated according to the example equals the checksum indicated on the display of the relay module, the switches in the concerned switchgroup are properly set.

Switch No	Pos.		Weight	Value
1	1	x	1	= 1
2	0	x	2	= 0
3	1	x	4	= 4
4	1	x	8	= 8
5	1	x	16	= 16
6	0	x	32	= 0
7	1	x	64	= 64
8	0	x	128	= 0
Checksum			Σ	= 93

Fig. 2. Example of calculating the checksum of a selector switchgroup SG_.

The functions of the selector switches of the different protection relay modules are described in detail in the manuals of the different relay modules.

Settings

Most of the start values and operate times are set by means of the display and the push buttons on the front panel of the relay modules. Each setting has its related indicator which is lit when the concerned setting value is shown on the display.

In addition to the main stack of setting values most D type relay modules allow a second stack of settings. Switching between the main settings

and the second settings can be done in three different ways:

- 1) By command V150 over the serial communication bus
- 2) By an external control signal BS1, BS2 or RRES (BS3)
- 3) Via the push-buttons of the relay module, see submenu 4 of register A.

Setting mode

Generally, when a large number of settings is to be altered, e.g. during commissioning of relay systems, it is recommended that the relay settings are entered with the keyboard of a personal computer provided with the necessary software. When no computer nor software is available or when only a few setting values need to be altered the procedure described below is used.

The registers of the main menu and the submenus contain all parameters that can be set. The settings are made in the so called setting mode, which is accessible from the main menu or a submenu by pressing the PROGRAM push button, until the whole display starts flashing. This position indicates the value of the parameter before it has been altered. By pressing the PROGRAM push button the programming sequence moves forward one step. First the rightmost digit starts flashing while the rest of the display is steady. The flashing digit is set by means of the STEP push button. The flashing

cursor is moved on from digit to digit by pressing the PROGRAM push button and in each stop the setting is performed with the STEP push button. After the parameter values have been set, the decimal point is put in place. At the end the position with the whole display flashing is reached again and the data is ready to be stored.

A set value is recorded in the memory by pressing the push buttons STEP and PROGRAM simultaneously. Until the new value has been recorded a return from the setting mode will have no effect on the setting and the former value will still be valid. Furthermore *any attempt to make a setting outside the permitted limits for a particular parameter will cause the new value to be disqualified and the former value will be maintained.* Return from the setting mode to the main menu or a submenu is possible by pressing the PROGRAM push button until the green digits on the display stop flashing.

NOTE! During any local man-machine communication over the push buttons and the display on the front panel a five minute time-out function is active. Thus, if no push button has been pressed during the last five minutes, the relay returns to its normal state automatically. This means that the display turns dark, the relay escapes from a display mode, a programming routine or any routine going on, when the relay is left untouched. This is a convenient way out of any situation when the user does not know what to do.

Before a relay module is inserted into the relay case, one must assure that the module has been given the correct settings. If there however is

any doubt about the settings of the module to be inserted, the setting values should be read using a spare relay unit or with the relay trip circuits disconnected. If this cannot be done the relay can be set into a non-tripping mode by pressing the PROGRAM push button and powering up the relay module simultaneously. The display will show three dashes "---" to indicate the non-tripping mode. The serial communication is operative and all main and submenus are accessible. In the non-tripping mode unnecessary trippings are avoided and the settings can be checked. *The normal protection relay mode is entered automatically after a timeout of five minutes or ten seconds after the dark display position of the main menu has been entered.*

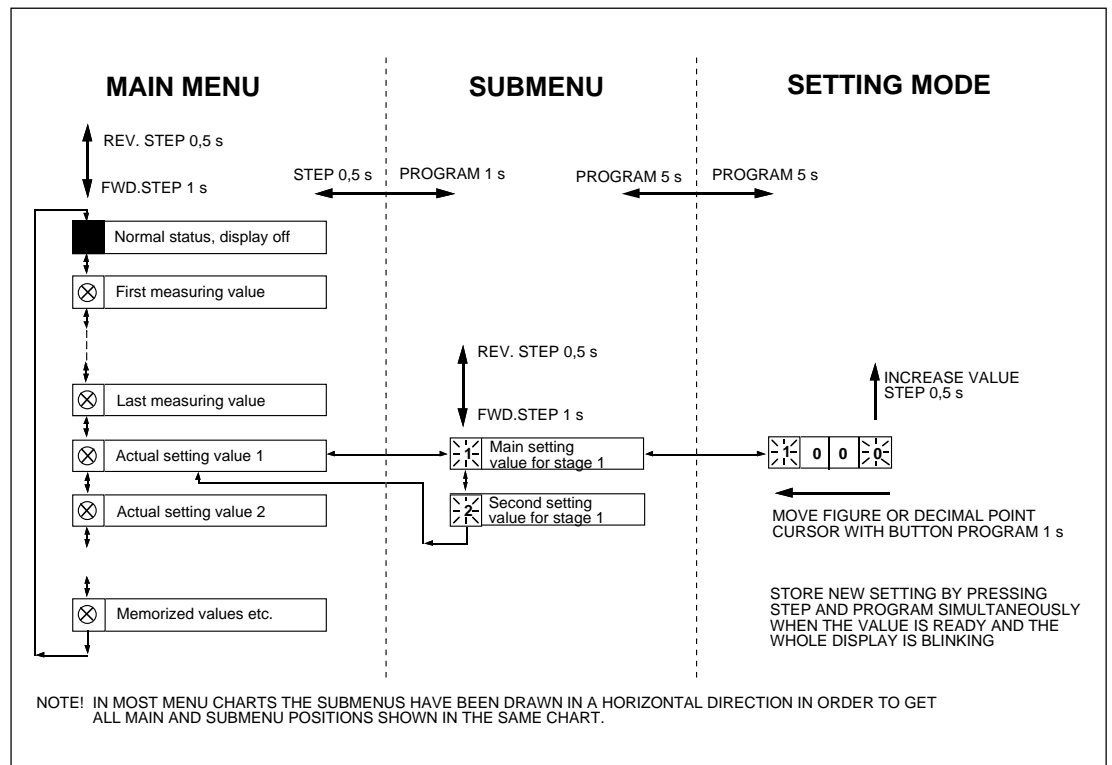

Fig.3. Basic principles of entering the main menus and submenus of a relay module.

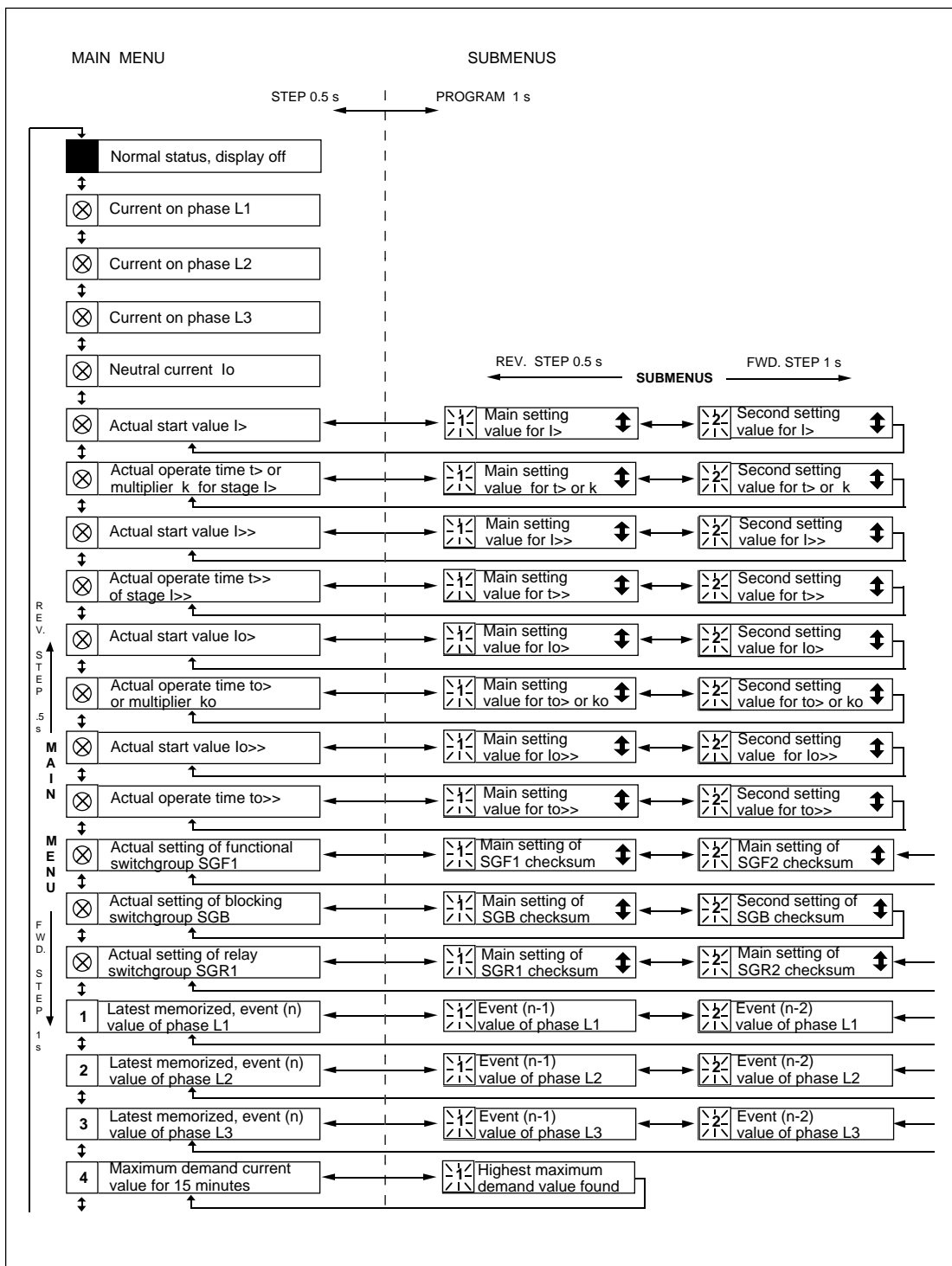

Fig. 4. Example of part of the main and submenus for the settings of the overcurrent and earth-fault relay module SPCJ 4D29. The settings currently in use are in the main menu and they are displayed by pressing the STEP push button. The main menu also includes the measured current values, the registers 1...9, 0 and A. The main and second setting values are located in the submenus and are called up on the display with the PROGRAM push button.

Example 1

Operation in the setting mode. Manual setting of the main setting of the start current value $I>$ of an overcurrent relay module. The initial value

for the main setting is $0.80 \times I_n$ and for the second setting $1.00 \times I_n$. The desired main start value is $1.05 \times I_n$.

a) Press push button STEP repeatedly until the LED close to the $I>$ symbol is lit and the current start value appears on the display.

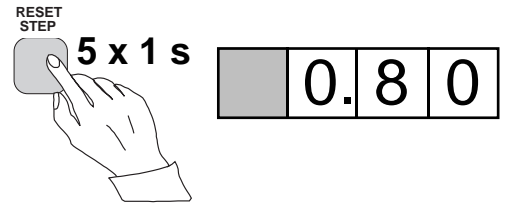

b) Enter the submenu to get the main setting value by pressing the PROGRAM push button more than one second and then releasing it. The red display digit now shows a flashing number 1, indicating the first submenu position and the green digits show the set value.

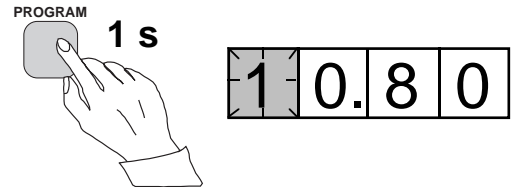

c) Enter the setting mode by pressing the PROGRAM push button for five seconds until the display starts flashing.

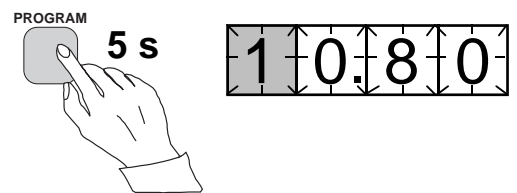

d) Press the PROGRAM push button once again for one second to get the rightmost digit flashing.

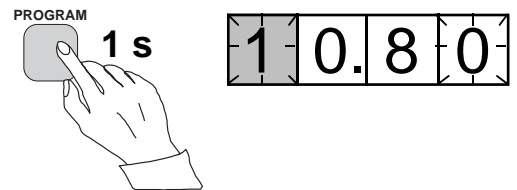

e) Now the flashing digit can be altered. Use the STEP push button to set the digit to the desired value.

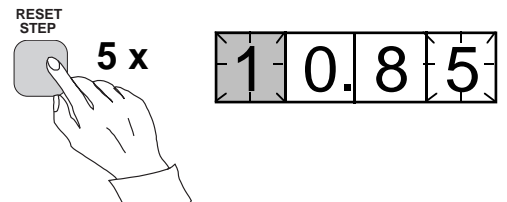

f) Press the PROGRAM push button to make the middle one of the green digits flash.

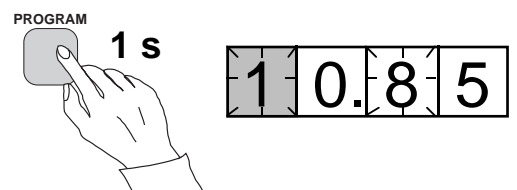

g) Set the middle digit with of the STEP push button.

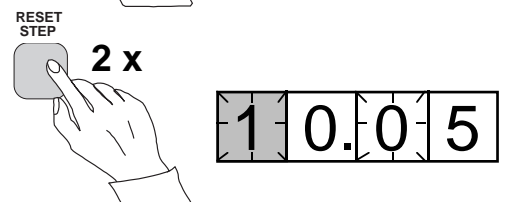

h) Press the PROGRAM push button to make the leftmost green digit flash.

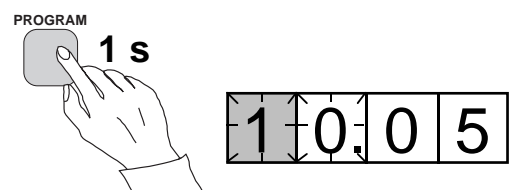

i) Set the digit with the STEP push button.

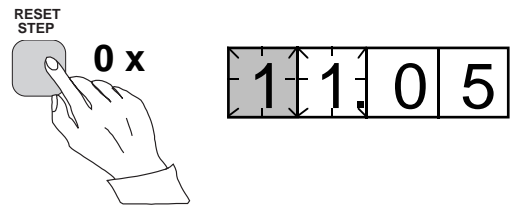

j) Press the PROGRAM push button to make the decimal point flash.

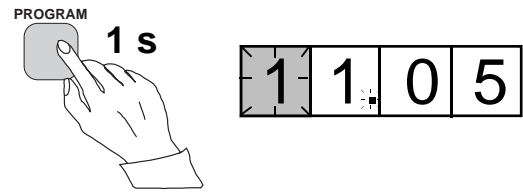

k) If needed, move the decimal point with the STEP push button.

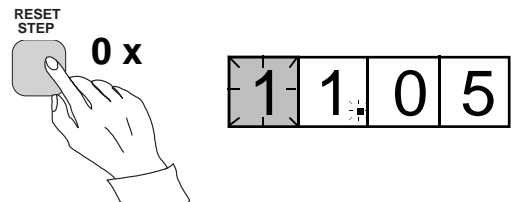

l) Press the PROGRAM push button to make the whole display flash. In this position, corresponding to position c) above, one can see the new value before it is recorded. If the value needs changing, use the PROGRAM push button to alter the value.

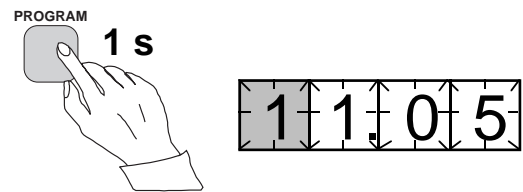

m) When the new value has been corrected, record it in the memory of the relay module by pressing the PROGRAM and STEP push buttons simultaneously. At the moment the information enters the memory, the green dashes flash once in the display, i.e. 1 - - -.

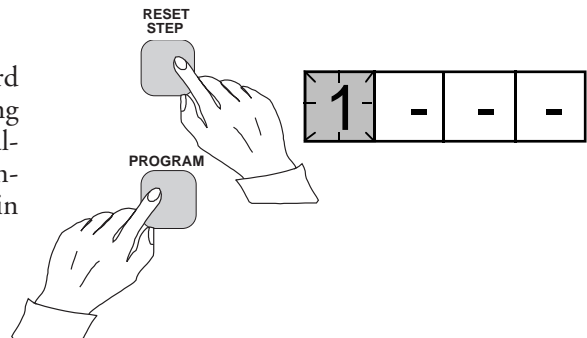

n) Recording of the new value automatically initiates a return from the setting mode to the normal submenu. Without recording one can leave the setting mode any time by pressing the PROGRAM push button for about five seconds, until the green display digits stop flashing.

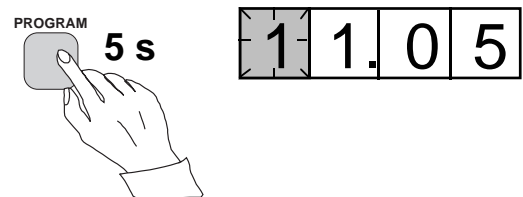

o) If the second setting is to be altered, enter submenu position 2 of the setting I> by pressing the STEP push button for approx. one second. The flashing position indicator 1 will then be replaced by a flashing number 2 which indicates that the setting shown on the display is the second setting for I>.

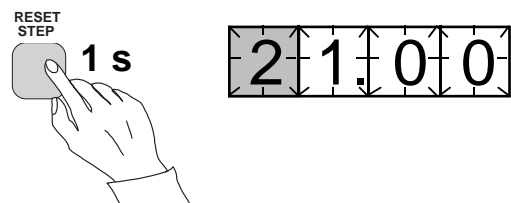

Enter the setting mode as in step c) and proceed in the same way. After recording of the requested values return to the main menu is obtained by pressing the STEP push button

until the first digit is switched off. The LED still shows that one is in the I> position and the display shows the new setting value currently in use by the relay module.

Example 2

Operation in the setting mode. Manual setting of the main setting of the checksum for the switchgroup SGF1 of a relay module. The initial value for the checksum is 000 and the switches

SGF1/1 and SGF1/3 are to be set in position 1. This means that a checksum of 005 should be the final result.

a) Press push button STEP until the LED close to the SGF symbol is lit and the checksum appears on the display.

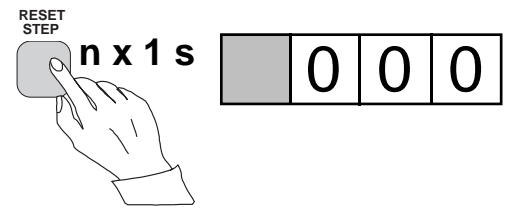

b) Enter the submenu to get the main checksum of SGF1 by pressing the PROGRAM push button for more than one second and then releasing it. The red display now shows a flashing number 1 indicating the first submenu position and the green digits show the checksum.

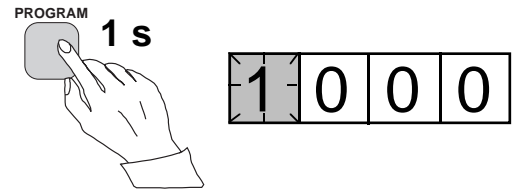

c) Enter the setting mode by pressing the PROGRAM push button for five seconds until the display starts flashing.

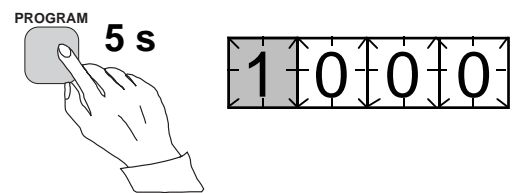

d) Press the PROGRAM push button once again to get the first switch position. The first digit of the display now shows the switch number. The position of the switch is shown by the rightmost digit.

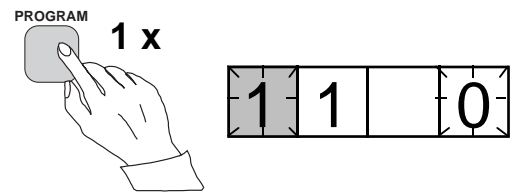

e) The switch position can now be toggled between 1 and 0 by means of the STEP push button and it is left in the requested position 1.

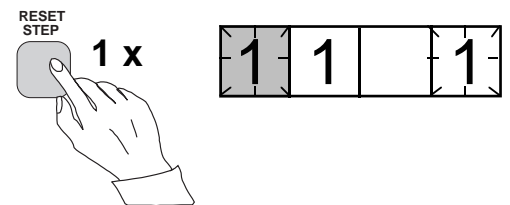

f) When switch number 1 is in the requested position, switch number 2 is called up by pressing the PROGRAM push button for one second. As in step e), the switch position can be altered by using the STEP push button. As the desired setting for SGF1/2 is 0 the switch is left in the 0 position.

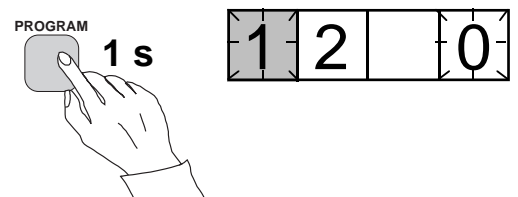

g) Switch SGF1/3 is called up as in step f) by pressing the PROGRAM push button for about one second.

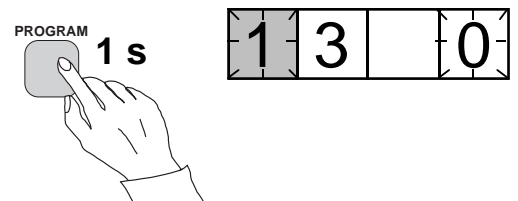

h)
The switch position is altered to the desired position 1 by pressing the STEP push button once.

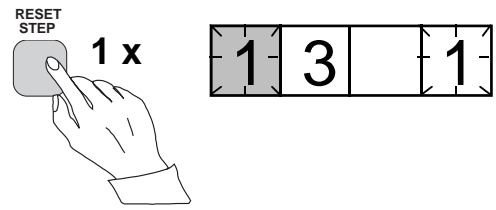

i)
Using the same procedure the switches SGF 1/4...8 are called up and, according to the example, left in position 0.

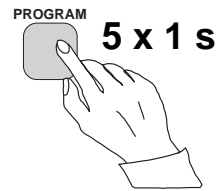

j)
In the final setting mode position, corresponding to step c), the checksum based on the set switch positions is shown.

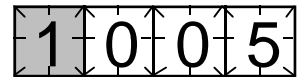

k)
If the correct checksum has been obtained, it is recorded in the memory by pressing the push buttons PROGRAM and STEP simultaneously. At the moment the information enters the memory, the green dashes flash in the display, i.e. 1 - - -. If the checksum is incorrect, the setting of the separate switches is repeated using the PROGRAM and STEP push buttons starting from step d).

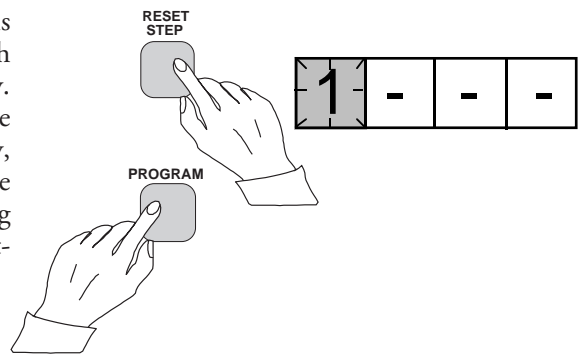

l)
Recording the new value automatically initiates a return from the setting mode to the normal menu. Without recording one can leave the setting mode any time by pressing the PROGRAM push button for about five seconds, until the green display digits stop flashing.

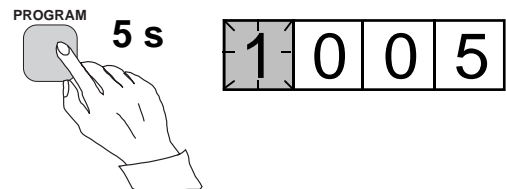

m)
After recording the desired values return to the main menu is obtained by pressing the STEP push button until the first digit is turned off. The LED indicator SGF still shows that one is in the SGF position and that the display shows the new checksum for SGF1 currently in use by the relay module.

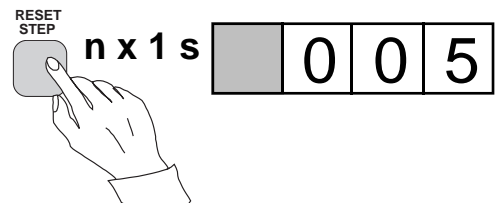

Recorded information

The parameter values measured at the moment when a fault occurs or at the trip instant are recorded in the registers. The recorded data, except for some parameters, are set to zero by pressing the push buttons STEP and PROGRAM simultaneously. The data in normal registers are erased if the auxiliary voltage supply to the relay is interrupted, only the set values and certain other essential parameters are maintained in non-volatile registers during a voltage failure.

The number of registers varies with different relay module types. The functions of the registers are illustrated in the descriptions of the different relay modules. Additionally, the system front panel of the relay contains a simplified list of the data recorded by the various relay modules of the protection relay.

All D type relay modules are provided with two general registers: register 0 and register A.

Register 0 contains, in coded form, the information about e.g. external blocking signals, status information and other signals. The codes are explained in the manuals of the different relay modules.

Register A contains the address code of the relay modul which is required by the serial communication system.

Submenu 1 of register A contains the data transfer rate value, expressed in kilobaud, of the serial communication.

Submenu 2 of register A contains a bus communication monitor for the SPAbus. If the protection relay, which contains the relay module, is linked to a system including a control data communicatoe, for instance SRIO 1000M and the data communication system is operating, the counter reading of the monitor will be zero. Otherwise the digits 1...255 are continuously scrolling in the monitor.

Submenu 3 contains the password required for changing the remote settings. The address code, the data transfer rate of the serial communication and the password can be set manually or via the serial communication bus. For manual setting see example 1.

The default value is 001 for the address code, 9.6 kilobaud for the data transfer rate and 001 for the password.

In order to secure the setting values, all settings are recorded in two separate memory banks within the non-volatile memory. Each bank is complete with its own checksum test to verify the condition of the memory contents. If, for some reason, the contents of one bank is disturbed, all settings are taken from the other bank and the contents from here is transferred to the faulty memory region, all while the relay is in full operation condition. If both memory banks are simultaneously damaged the relay will be set out of operation, and an alarm signal will be given over the serial port and the IRF output relay

Trip test function

Register 0 also provides access to a trip test function, which allows the output signals of the relay module to be activated one by one. If the auxiliary relay module of the protection assembly is in place, the auxiliary relays then will operate one by one during the testing.

When pressing the PROGRAM push button for about five seconds, the green digits to the right start flashing indicating that the relay module is in the test position. The indicators of the settings indicate by flashing which output signal can be activated. The required output function is selected by pressing the PROGRAM push button for about one second.

The indicators of the setting quantities refer to the following output signals:

Setting I>	Starting of stage I>
Setting t>	Tripping of stage I>
Setting I>>	Starting of stage I>>
Setting t>>	Tripping of stage I>>
etc.	
No indication	Self-supervision IRF

The selected starting or tripping is activated by simultaneous pressing of the push buttons STEP and PROGRAM. The signal remains activated as long as the two push buttons are pressed. The effect on the output relays depends on the configuration of the output relay matrix switches.

The self-supervision output is activated by pressing the STEP push button 1 second when no setting indicator is flashing. The IRF output is activated in about 1 second after pressing of the STEP push button.

The signals are selected in the order illustrated in Fig. 4.

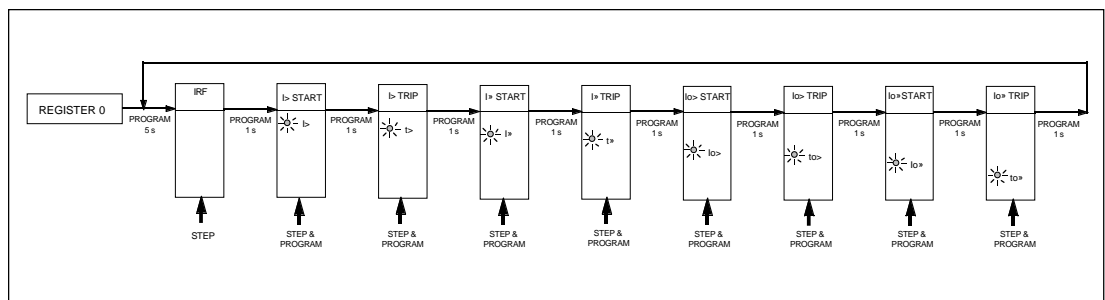

Fig. 5. Sequence order for the selection of output signals in the Trip test mode

If, for instance, the indicator of the setting t> is flashing, and the push buttons STEP and PROGRAM are being pressed, the trip signal from the low-set overcurrent stage is activated. Return to the main menu is possible at any stage of the trip test sequence scheme, by pressing the PROGRAM push button for about five seconds.

Note!
The effect on the output relays then depends on the configuration of the output relay matrix switchgroups SGR 1...3.

Example 3

Trip test function. Forced activation of the outputs.

- a)
Step forward on the display to register 0.

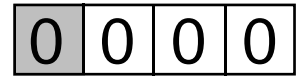
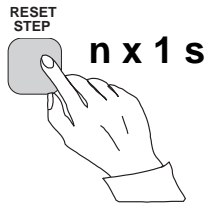

- b)
Press the PROGRAM push button for about five seconds until the three green digits to the right.

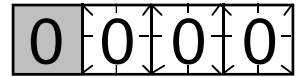
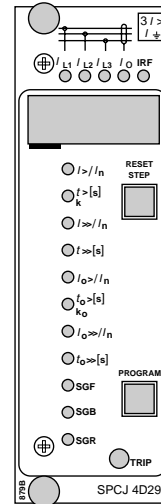
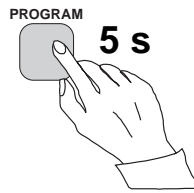

- c)
Hold down the STEP push button. After one second the red IRF indicator is lit and the IRF output is activated. When the step push button is released the IRF indicator is switched off and the IRF output resets.

- d)
Press the PROGRAM push button for one second and the indicator of the topmost setting start flashing.

- e)
If a start of the first stage is required, now press the push-buttons PROGRAM and STEP simultaneously. The stage output will be activated and the output relays will operate according to the actual programming of the relay output switchgroups SGR.

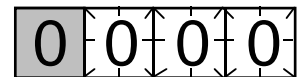
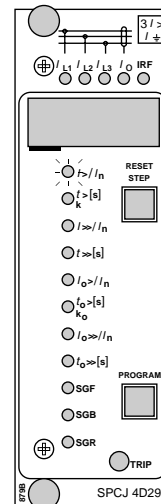
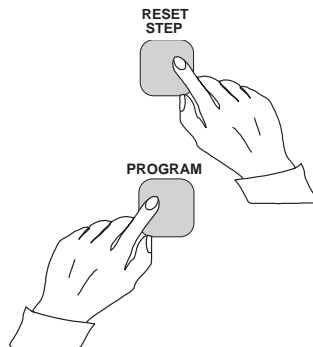

f)
To proceed to the next position press the PROGRAM push button for about 1 second until the indicator of the second setting starts flashing.

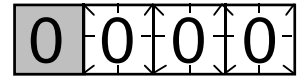
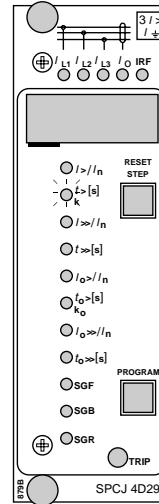

g)
Press the push buttons PROGRAM and STEP simultaneously to activate tripping of stage 1 (e.g. the I> stage of the overcurrent module SPCJ 4D29). The output relays will operate according to the actual programming of the relay switchgroups SGR. If the main trip relay is operated the trip indicator of the measuring module is lit.

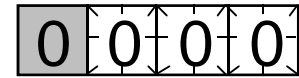
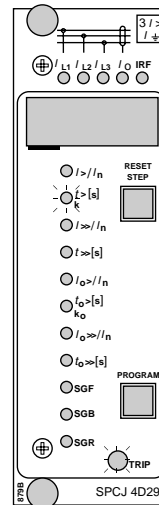
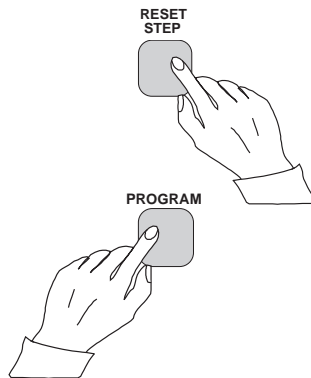

h)
The starting and tripping of the remaining stages are activated in the same way as the first stage above. The indicator of the corresponding setting starts flashing to indicate that the concerned stage can be activated by pressing the STEP and PROGRAM buttons simultaneously. For any forced stage operation, the output relays will respond according to the setting of the relay output switchgroups SGR. Any time a certain stage is selected that is not wanted to operate, pressing the PROGRAM button once more will pass by this position and move to the next one without carrying out any operation of the selected stage.

It is possible to leave the trip test mode at any step of the sequence scheme by pressing the PROGRAM push button for about five seconds until the three digits to the right stop flashing.

Operation indication

A relay module is provided with a multiple of separate operation stages, each with its own operation indicator shown on the display and a common trip indicator on the lower part of the front plate of the relay module.

The starting of a relay stage is indicated with one number which changes to another number when the stage operates. The indicator remains glowing although the operation stage resets. The

indicator is reset by means of the RESET push button of the relay module. An unreset operation indicator does not affect the function of the protection relay module.

In certain cases the function of the operation indicators may deviate from the above principles. This is described in detail in the descriptions of the separate modules.

Fault codes

In addition to the protection functions the relay module is provided with a self-supervision system which continuously supervises the function of the microprocessor, its program execution and the electronics.

Shortly after the self-supervision system detects a permanent fault in the relay module, the red IRF indicator on the front panel is lit. At the same time the module puts forward a control signal to the output relay of the self-supervision system of the protection relay.

In most fault situations a fault code, indicating the nature of the fault, appears on the display of

the module. The fault code, which consists of a red figure "1" and a three digit green code number, cannot be removed from the display by resetting. When a fault occurs, the fault code should be recorded and stated when service is ordered. When in a fault mode, the normal relay menus are operative, i.e. all setting values and measured values can be accessed although the relay operation is inhibited. The serial communication is also operative making it possible to access the relay information also from a remote site. The internal relay fault code shown on the display remains active until the internal fault possibly disappears and can also be remotely read out as variable V 169.

SPCJ 4D34

Motor protection relay module

User's manual and Technical description

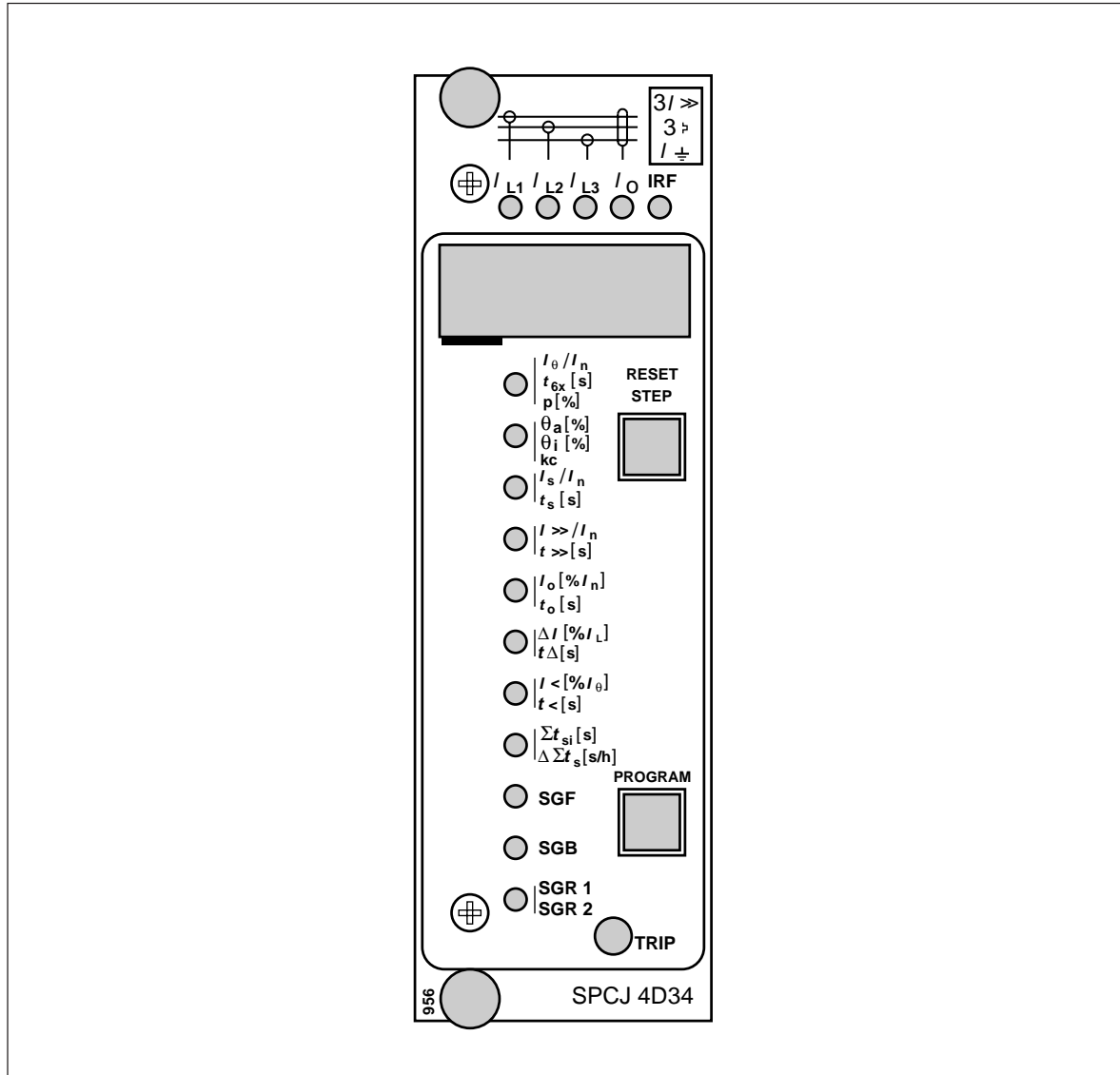

SPCJ 4D34

Motor protection relay module

Data subject to change without notice

Contents

Characteristics	3
Description of units	3
Thermal overload unit	3
Time/current characteristics	5
Start-up supervision unit	7
High-set overcurrent unit	8
Earth-fault unit	9
Phase unbalance unit	10
Incorrect phase sequence unit	11
Undercurrent unit	11
Cumulative start-up time counter	11
Self-supervision	11
Block diagram	12
Front panel	13
Operation indicators	14
Relay settings	15
Programming switches	16
Example of switchgroup checksum calculation	19
Measured data	20
Recorded information	20
Main menus and submenus of settings and registers	22
Technical data	24
Serial communication	26
Event codes	26
Remote transfer data	28
Fault codes	33

Characteristics	Thermal overload protection with the motor full load current setting range $0.5...1.50 \times I_n$ and with the safe stall time setting range $2...120$ s. Features also prior alarm and restart inhibition, reduced cooling at standstill etc.	Separate incorrect phase sequence protection with a operate time of 600 ms
	High-set overcurrent stage $I_{>>}$ with the setting range $0.5...20 \times I_n$ with a definite time operation $0.04...30$ s. The operation of the high-set overcurrent stage can be set out of function with a switch	Start-up supervision unit, operating on definite time overcurrent or thermal stress counting with a control input for a motor speed switch signal Undercurrent protection e.g. for protection of conveyors or submersible pump drives
	Sensitive low-set non-directional neutral overcurrent stage $I_{0>}$ with the setting range $1.0...100\% I_n$, based on definite time characteristic, with a setting range $0.05...30$ s	Cumulative start-up time counter protecting against too frequent start-up attempts
	Unbalance protection with setting range $10...40\% I_L$, fully stabilized to the load current, based on inverse time characteristic and with a basic time setting range $20...120$ s	Digital display of measured and set values and sets of data recorded at the moment of tripping All settings can be keyed in using the push-buttons on the front panel, can be set by using a personal computer or via the serial communication
		Continuous self-supervision including both hardware and software. At a permanent fault the self-supervision output relay operates and the other output relays are blocked

Description of units

Thermal overload unit

The thermal overload unit constitutes an adequate thermal protection for the motor under varying load conditions. The heating-up of a motor follows an exponential curve, the level-out value of which is determined by the squared value of the load current. The operating values of the thermal unit are defined by means of two relay settings. The full load current (FLC) setting I_θ defines the thermal operating level of the unit and the time setting t_{6x} defines the operate time. The setting t_{6x} is the operate time of the thermal unit at six times FLC, starting from a cold motor condition.

The thermal unit comprises two different thermal curves, one describing short and long time overloads, carrying out the tripping and another curve keeping track of the thermal background. A weighting factor p which determines the ratio of thermal increase of the two curves is settable between 20% and 100%. For direct on-line started motors having a characteristic hot-spot behaviour p is typically set at 50%. For the protection of objects without hot-spot characteristics, e.g. cables or motors started with soft starters, a setting $p = 100\%$ is used.

A multiplexer continuously monitors the energizing input signals and selects the highest phase value. As long as the motor current stays below the set full load current I_θ , the relay will not cause a tripping. It only monitors the thermal condition of the motor, in order to take the prior thermal history into account under a heavy load condition. If the current continuously exceeds the set full load current value I_θ by more than five per cent, all of the thermal capacity of the motor will be used after a time, which depends on the set FLC, the set stall time and the prior load of the motor. When the thermal level exceeds the set prior alarm level θ_a , a prior alarm signal is given, if routed to an output relay with switch SGR1/1 or SGR2/1. The prior alarm is indicated by a figure 1 on the display. Tripping due to overload is indicated by a figure 2 and carried out when the thermal level exceeds 100%. Whenever the thermal capacity has reached a level above the set thermal restart inhibit level θ_i , the restart enable output relay is disengaged. In this way, unnecessary motor start-up attempts are prevented. During the restart inhibit time a figure 3 is presented on the display, after that the other thermal function indications have been acknowledged.

An estimate of the waiting time left, before a successful restart can be made, is found in register 9. For thermal operate times, see the thermal trip diagrams on page 4 and 5. The restart inhibit function can be set out of operation by turning switch SG4/2 in position 1.

For varying currents, the thermal unit behaves in different ways depending on the value of the weighting factor p :

- When e.g. $p = 50\%$ the thermal unit takes into account the hot spot behaviour of the motor and distinguishes between short time thermal stress and a long time thermal history background. After a short period of thermal stress, e.g. a start-up, the thermal level quite rapidly decreases, thus simulating the levelling out of the motor hot spots. This means that the availability of the motor is higher for successive start-ups. This can be seen by comparing the hot and cold curves on page 4 and 5.
- When $p = 100\%$, the thermal level after a heavy load condition only slowly decreases according to the new lower load level. This makes the unit suitable for applications, where no hot spot behaviour is to be expected, e.g. motors started with soft starters or cables or similar objects, where no hot spots exist.

A standstill of the motor is determined by the motor current being less than 12 per cent of I_{θ} . During a standstill condition, the reduced cooling properties of the motor are taken into account by making the cooling time constant longer than the heating time constant determined by the t_{6x} setting. The multiplier k_c of the heating time constant to obtain the cooling time constant can be adjusted within the integer range 1...64.

A start-up condition of the motor is defined by a sequence, where the initial current is less than 12% of I_{θ} , i.e. the motor is at standstill, and where the current within about 60 ms rises to a value higher than 1.5 times I_{θ} . When the current falls below 1.25 times I_{θ} for a time of about 100 ms, the start-up condition is defined to be over. The start-up counter is incremented for every start and can indicate up to 999 starts, after which it starts counting from zero again. The start-up time refers to the time the current value is between the two current levels mentioned above. It should be noted that a start-up clears all front panel indications and writes a new set of memorized operational values. The start-up information can be routed to output SS1.

After a loss of auxiliary supply or whenever powered up, the relay assumes the motor to be heated up to a level corresponding to about 70 per cent of the full thermal capacity of the motor. This ensures that under heavy load conditions, tripping is carried out in a safe time. Under a low-load condition, the thermal replica of the relay slowly decays to the actual level determined by the motor currents.

Note!

At low prior alarm settings the connection of the auxiliary supply to the relay will cause a thermal prior alarm because of the initialization to 70%. A cold 0% thermal reference level for testing can be established by keeping both buttons depressed on powering-up.

Time/current characteristics

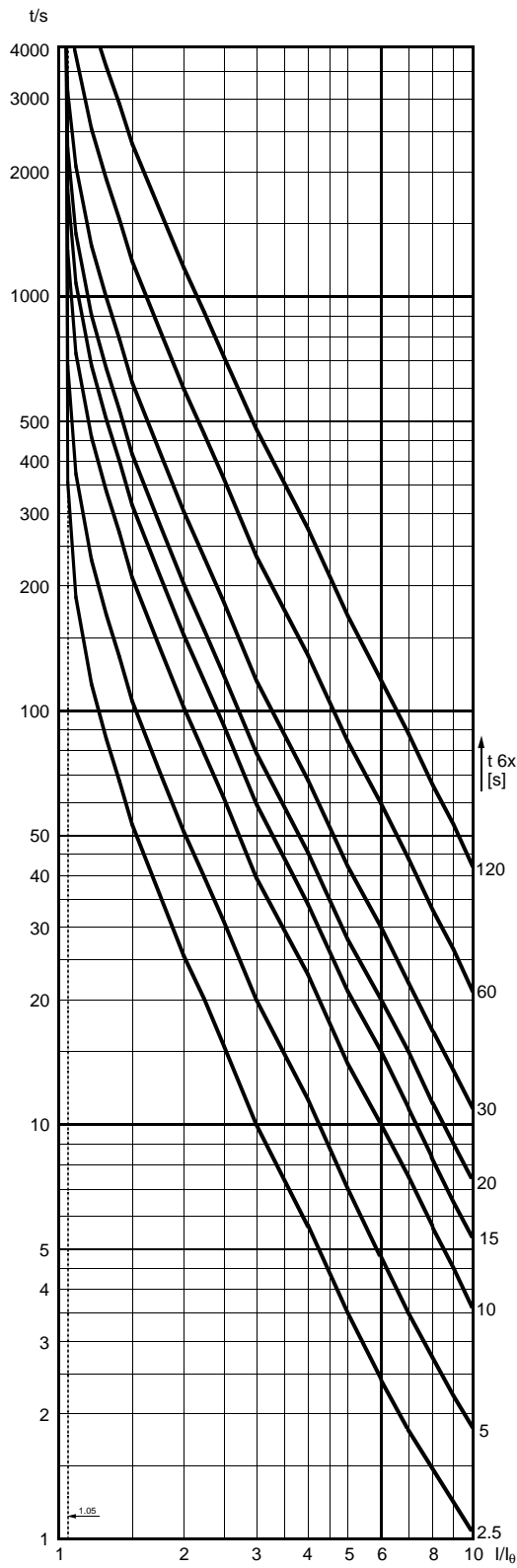

Fig. 1. Trip curves for the thermal unit with no prior load ("cold curve"); $p = 20 \dots 100 \%$

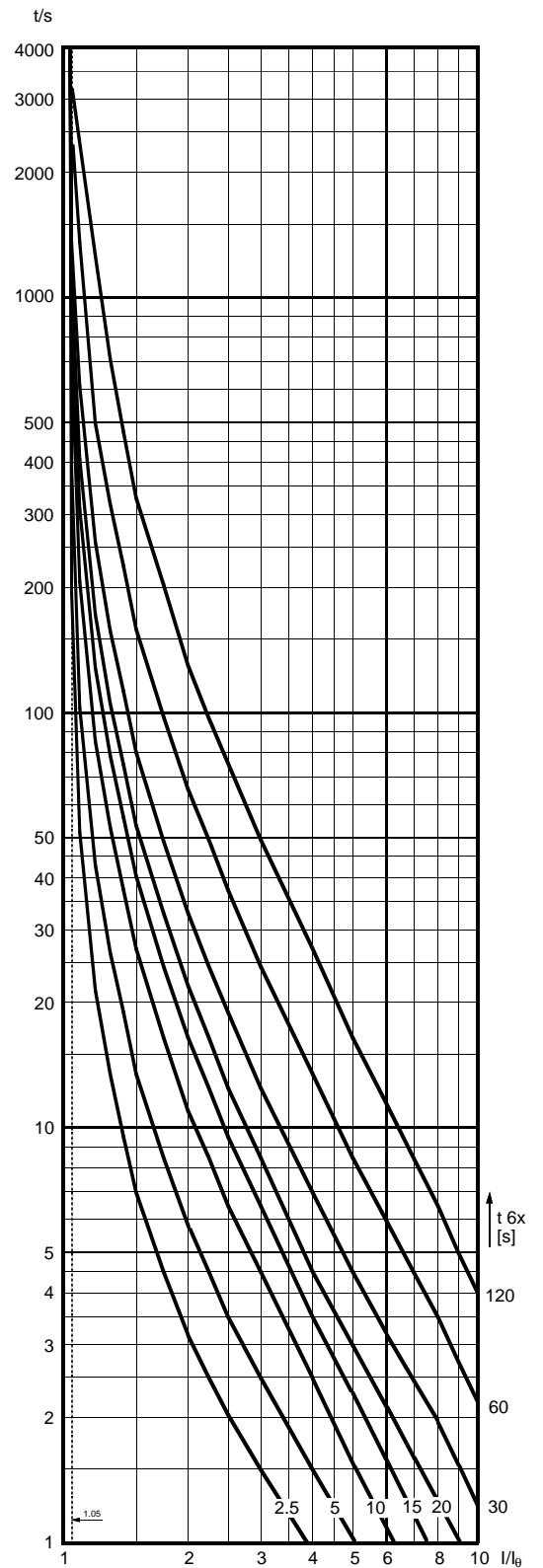

Fig. 2. Trip curves for the thermal unit with prior load $1.0 \times I_{\theta}$ ("hot curve") at $p = 100 \%$.

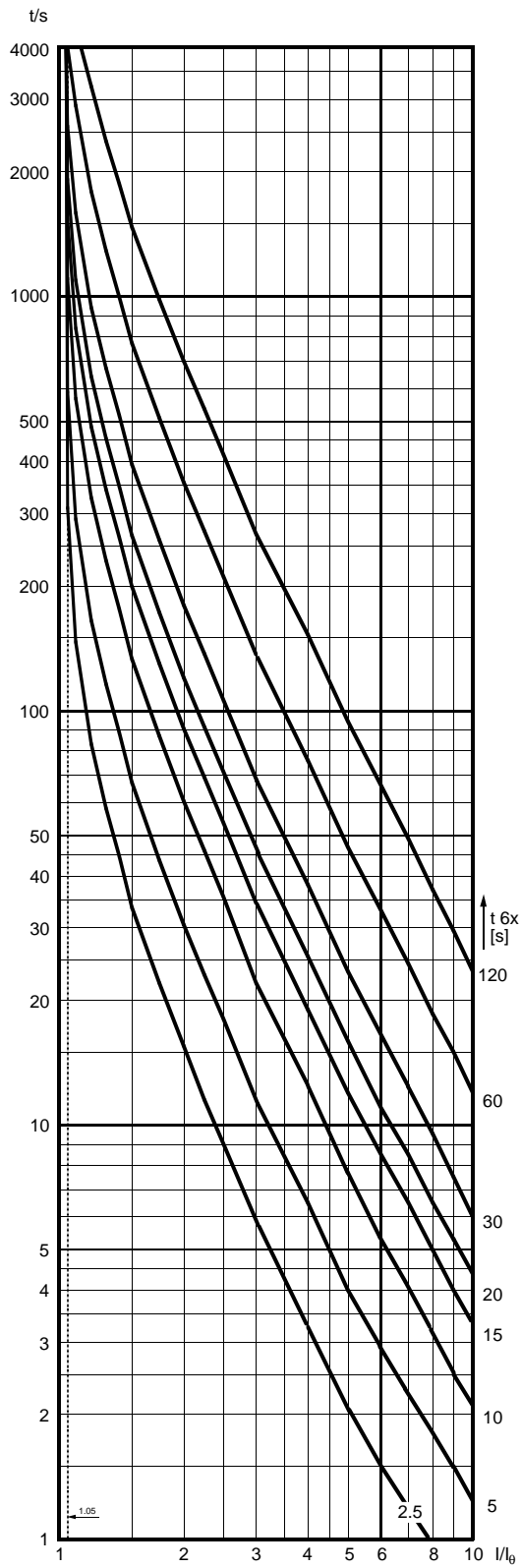

Fig. 3. Trip curves for the thermal unit with prior load $1.0 \times I_{\theta}$ ("hot curve") at $p = 50\%$.

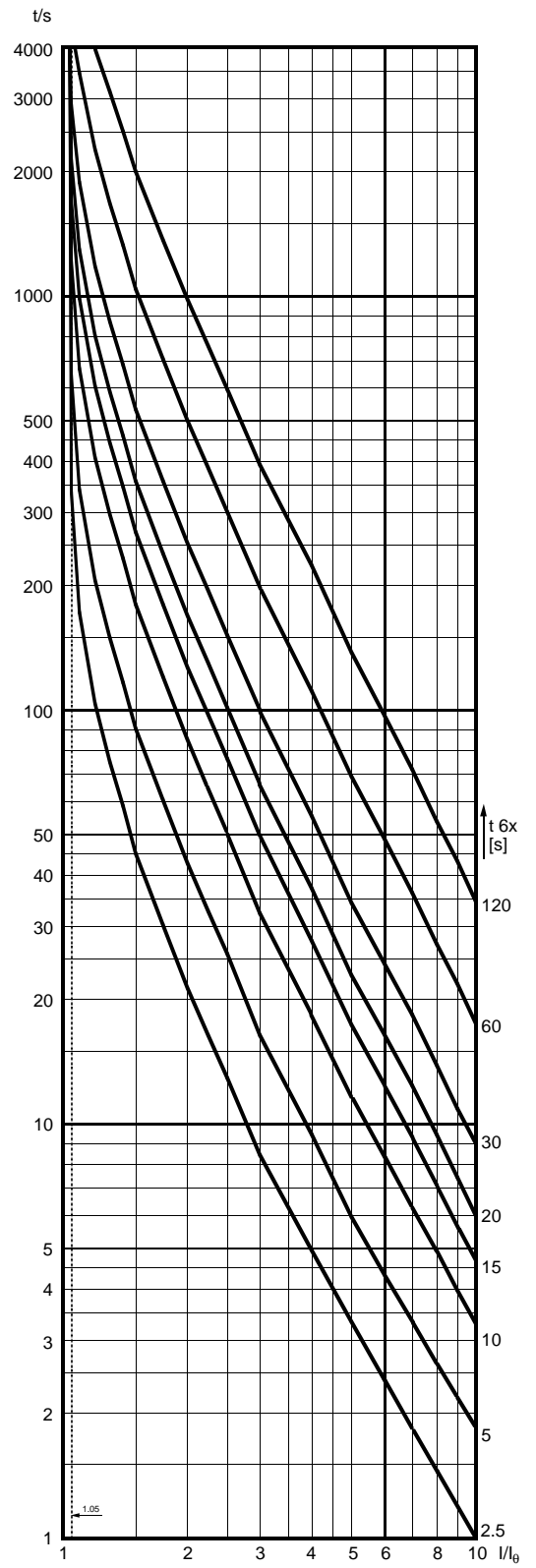

Fig. 4. Trip curves for the thermal unit with prior load $1.0 \times I_{\theta}$ ("hot curve") at $p = 20\%$.

The start-up stall protection can be carried out in two ways as selected with switch SGF/7:

1. Start-up supervision based on definite time overcurrent protection

The most straightforward way is to monitor the start-up time using a definite time overcurrent function. The start condition is detected by the fact that the setting I_s is exceeded and the allowed start-up time is set as t_s . The disadvantage with this configuration is that the maximum allowed start-up time is fixed and does not allow for a growing start-up time during a low voltage condition.

The overcurrent stage starts if the current on one or several phases exceeds the setting value. If the overcurrent situation lasts long enough to exceed the set operating time, the unit calls for a C.B. tripping by issuing a tripping signal. At the same time the operation indicator is lit with red light and the display shows a red figure 6. The red operation indicators remain on although the protection stage resets. The indicators are reset with the RESET push-button. By proper configuration of the output relay switchgroups a trip signal can be generated from the signal SS2 or SS3. The start signal can be routed directly to the output SS1 via switch SG4/3.

The current I > setting range of the stage is $1.0...10 \times I_n$. The operate time t_s of the overcurrent stage is set within the range $0.3...80$ s.

The operation of the low-set overcurrent unit is provided with a latching feature (switch SGB/8), which keeps the trip output energized, although the fault that caused the operation has disappeared. The output relay may be reset in five different ways; a) by pressing the PROGRAM push-button, b) by pressing the STEP and PROGRAM push-buttons simultaneously, by remote control over the SPA bus using c) the command V101 or d) the command V102 and further e) by remote control over the external control input. When resetting according to a) or c) no stored data are erased, but when resetting according to b), d) or e) the recorded data are erased.

2. Start-up supervision based on thermal stress calculation

The settings I_s and t_s can also be used in another way by selecting the function mode $I_s^2 \times t_s$ with selector switch SGF/7. In this case the current I_s is set equal to the actual start-up current of the motor and the time t_s is set to the normal start-up time of the motor. The relay now calculates the product $I_s^2 \times t_s$, which is equal

to the amount of thermal stress built up during a normal start-up of the motor. During the motor start-up the relay then continuously measures the start current, raises the value into the second power and multiplies it with the running time.

If the software switch SG4/1 has been set in position 1, the unit starts counting the $I_s^2 \times t_s$ value as soon as the start current value I_s is exceeded. When the counted value exceeds the set $I_s^2 \times t_s$ value the unit operates. The START signal can be routed directly to the output SS1 via switch SG4/3.

At operation the indicator is lit with red light and the display shows a red figure 6. The red operation indicators remain lit although the protection stage resets. The indicators are reset with the RESET push-button. By proper configuration of the output relay switchgroups a trip signal can be generated from the signal SS2 or SS3. This type of start-up monitoring also ensures that the low voltage conditions are catered for by allowing the start-up time to grow until the set maximum thermal stress is exceeded.

The start current setting range of the stage is $1.0...10 \times I_n$. The operate time t_s of the overcurrent stage is set within the range $0.3...80$ s.

The operation of the low-set overcurrent unit is provided with a latching feature (switch SGB/8), which keeps the tripping output energized, although the fault that caused the operation has disappeared. The output relay may be reset in five different ways; a) by pressing the PROGRAM push-button, b) by pressing the STEP and PROGRAM push-buttons simultaneously, by remote control over the SPA bus using c) the command V101 or d) the command V102 and further e) by remote control over the external control input. When resetting according to a) or c) no stored data are erased, but when resetting according to b), d) or e) the recorded data are erased.

3. Start-up supervision with a motor speed switch

For some ExE-type motors the safe stall time is shorter than the normal start-up time of the motor. In this case a speed switch on the motor shaft is needed to give information about whether the motor is beginning to run up or not when started. The information from the speed switch is routed to the control input terminals 10 and 11 on the relay. On activation of the control input the counting of the definite time or the building-up of thermal stress in the start-up supervision unit is inhibited.

High-set overcurrent unit

The high-set overcurrent stage starts if the current on one or several phases exceeds the setting value. When starting, the stage issues a starting signal. If the overcurrent situation lasts long enough to exceed the set operate time, the unit calls for a C.B. tripping by providing a tripping signal. At the same time the operation indicator is lit with red light. The red operation indicator remains on although the stage resets. The indicator is reset with the RESET push-button. The trip signal is always routed to output SS3 and can also, by programming, be routed to output SS2.

The start current setting range of the high-set overcurrent stage is $0.5...20 \times I_n$. The operate time $t_{>>}$ of the high-set overcurrent stage is set within the range 0.04...30 s.

The operation of the high-set overcurrent unit is provided with a latching feature (switch SGB/7 or SGB/8), which keeps the tripping output energized, although the fault that caused the operation has disappeared. The output relay may be reset in five different ways; a) by pressing the PROGRAM push-button, b) by pressing the STEP and PROGRAM push-buttons simulta-

neously, by remote control over the SPA bus using c) the command V101 or d) the command V102 and further e) by remote control over the external control input. When resetting according to a) or c) no stored data are erased, but when resetting according to b), d) or e) the recorded data are erased.

The setting value $I_{>>}/I_n$ of the high-set overcurrent stage may be given an automatic doubling function when the protected object is connected to the network, i.e. in a starting situation. Hence the setting value of the high-set overcurrent stage may be lower than the connection inrush current. The automatic doubling function is selected with switch SGF/2. The starting situation is defined as a situation where the phase currents rise from a value below $0.12 \times I_{\theta}$ to a value exceeding $1.5 \times I_{\theta}$ in less than 60 ms. The starting situation ends when the currents fall below $1.25 \times I_{\theta}$.

The high-set overcurrent stage may be set out of operation by means of switch SGF/1. When the high-set unit is set out of operation the display shows a " - - - " readout, indicating that the operation value is infinite.

Earth-fault unit

The sensitive, non-directional earth-fault unit of the module SPCJ 4D34 is a single-pole neutral overcurrent unit. It contains a low-set overcurrent stage $I_{0>}$ with the setting range 1.0...100% I_n . The operate time can be set within the range 0.05...30 s.

The stage starts and provides a starting signal if the measured current exceeds the setting value. If the current lasts long enough to exceed the set operate time, the unit calls for a C.B. tripping by providing a tripping signal. The operation of the earth-fault unit is indicated with a figure 7 on the display on the relay front panel. At the same time the red operation indicator of the tripping stage is lit. The operation indicators remain on although the stage resets. The indicators are reset with the RESET push-button. If the unit is programmed to be signalling only, i.e. the route through SGR1/8 to the trip relay is left open, the trip indicator will reappear as long as the unit is activated. By proper configuration of the output relay switchgroups a trip signal can be generated from the signal SS2 or SS3.

The operation of the stage $I_{0>}$ can be blocked by applying a blocking signal BS on the stage. The blocking is programmed by means of switch SGB/4 on the front panel of the module.

The operation of the high-set stage of the earth-fault unit is provided with a latching feature (switch SGB/7 or SGB/8), which keeps the trip-

ping output energized, although the fault that caused the operation has disappeared. The output relay may be reset in five different ways; a) by pressing the PROGRAM push-button, b) by pressing the STEP and PROGRAM push-buttons simultaneously, by remote control over the SPA bus using c) the command V101 or d) the command V102 and further e) by remote control over the external control input. When resetting according to a) or c) no stored data are erased, but when resetting according to b), d) or e) the recorded data are erased.

To prohibit operation of the contactor in a contactor controlled drive at too high phase currents, the earth-fault unit can be inhibited during a high-current condition by selecting switch SGF/3 and SGF/4. In this case, the operation of the earth-fault unit is inhibited as soon as the phase currents exceed four, six or eight times the full load current I_θ , as selected with the two switches.

With isolated neutral networks it is in some cases possible to use the earth-fault unit in a non-tripping mode and only use the output for signalling. This function can be obtained by opening switch SGR1/8 which links the earth-fault unit to the trip output TS2. If the unit is selected to be tripping, both the trip output TS2 and the selected signal output relays are operated. If the unit is set to be signalling only, the trip output TS2 is not operated.

Phase unbalance unit

The phase current unbalance unit constitutes a single-phasing protection and an inverse time current unbalance protection.

The unbalance of the power system is detected by monitoring the highest and the lowest phase current values, i.e. the unbalance $\Delta I = 100\% \times (I_{Lmax} - I_{Lmin}) / I_{Lmax}$. At full unbalance the display shows 100 % which equals a negative phase sequence current $I_2 = 57.8\%$. If the unbalance exceeds the set operating level ΔI , the unit starts and a timer is started. The operate time depends on the degree of unbalance and the basic operate time setting t_{Δ} according to the diagram below. At the lowest selectable starting level, the operate time is equal to the set value t_{Δ} and for a full single-phasing condition, the operate time is about 1 second.

Unnecessary trippings at low current levels are avoided by the fact that for currents less than the full load current, the current value I_{Lmax} in the denominator part of the ΔI formula, is assumed to be equal to the full load current I_{θ} .

If the unbalance situation lasts long enough to exceed the set operate time, the unit requests C.B. tripping by providing a tripping signal. At the same time the operation indicator is lit with red light and the display shows a figure 5. The red operation indicators remain on although the stage resets. The indicators are reset with the RESET push-button. By proper configuration of the output relay switchgroups a trip signal can be generated from the signals SS2 or SS3.

The operation of the phase unbalance protection can be blocked by bringing a blocking signal BS to the unit. The blocking configuration is set by means of switchgroup SGB/3. With switch SGF/5 the unbalance unit can be made operative or set out of function.

The setting range of the start current is 10... 40 % I_L or ∞ (Indicated by "- - -"). The basic operate time t_{Δ} of the unbalance unit is set within the range 20...120 s.

The operation of the unbalance unit is provided with a latching feature (switch SGB/8), which keeps the tripping output energized, although the fault that caused the operation has disappeared. The output relay may be reset in five

different ways; a) by pressing the PROGRAM push-button, b) by pressing the STEP and PROGRAM push-buttons simultaneously, by remote control over the SPA bus using c) the command V101 or d) the command V102 and further e) by remote control over the external control input. When resetting according to a) or c) no stored data are erased, but when resetting according to b), d) or e) the recorded data are erased.

Note!

For a proper operation of the phase unbalance unit in a two-phase application, the two phase currents should be summed up in the third phase current transformer, i.e. a virtual third phase is established.

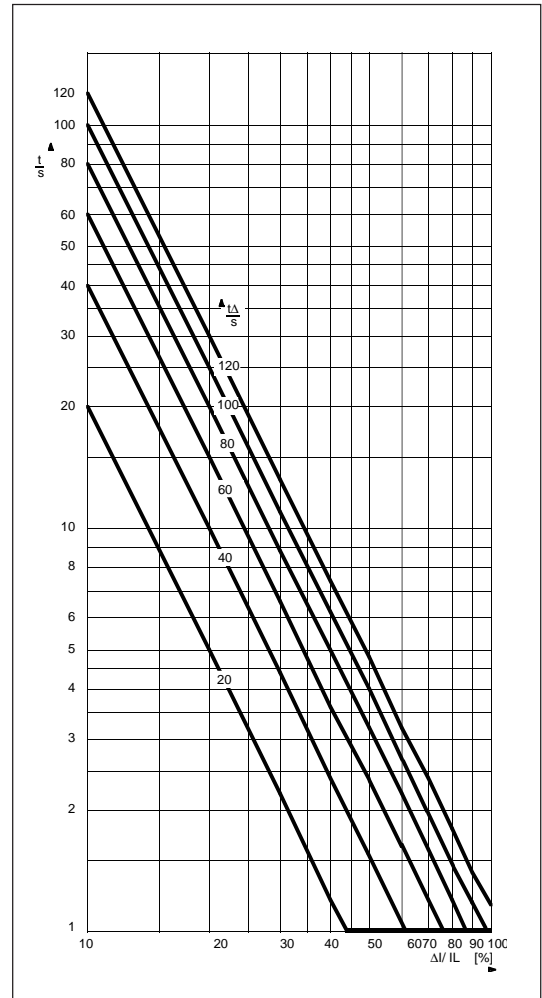

Fig. 5. The operate time of the unbalance protection as a function of the degree of unbalance

Incorrect phase sequence unit	<p>The incorrect phase sequence protection is based on the order of appearance for the positive half-waves of the phase currents. If the phase currents rise in an incorrect order, the unit starts and calls for a C.B. operation within less than</p>	<p>one second. The incorrect phase sequence protection can be selected or inhibited by the switch SGF/6. After an operation, the operation indicators and output relays are the same as for the previously described unbalance unit.</p>
Undercurrent unit	<p>The undercurrent unit constitutes a protection for the drive and the motor upon sudden loss of load. The undercurrent protection can be used in applications where the loss of load indicates a fault condition, e.g. with pumps or conveyors.</p> <p>The starting level of the unit is determined by the full load current setting I_{θ}. If the load is lost, the three phase currents fall below the set level and the unit starts. If the undercurrent condition persists for a time longer than the set operate time $t_{<}$, the unit calls for a C.B. tripping by providing a tripping signal. At the same time the operation indicator is lit with red light and the display shows a red figure 8. The red operation indicators remain lit although the stage resets. The indicators are reset with the RESET push-button. By proper configuration of the output relay switchgroups a trip signal can be generated from the signals SS2 or SS3.</p> <p>The start current setting range of the stage is 30...80% I_{θ}. The operate time $t_{<}$ is set within the range 2.0 ... 600 s.</p>	<p>In order not to trip a de-energized motor, the unit is inhibited at current levels below 12 per cent of the full load current.</p> <p>If the undercurrent protection is not required, the unit can be set out of operation with switch SGF/8. The setting is in this case displayed as " - - -".</p> <p>The operation of the undercurrent unit is provided with a latching feature (switch SGB/8), which keeps the tripping output energized, although the fault that caused the operation has disappeared. The output relay may be reset in five different ways; a) by pressing the PROGRAM push-button; b) by pressing the STEP and PROGRAM push-buttons simultaneously, by remote control over the SPA bus using c) the command V101 or d) the command V102 and further e) by remote control over the external control input. When resetting according to a) or c) no stored data are erased, but when resetting according to b), d) or e) the recorded data are erased.</p>
Cumulative start-up time counter	<p>Any time the motor is started, the start-up time is added to a register $\sum t_s$. If the contents of the register exceeds a preset level $\sum t_{si}$, any attempt to restart the motor will be inhibited, because the restart enable relay will be reset. Besides the maximum amount of accumulated start-up time, a resetting speed is also set, defining how</p>	<p>rapidly the contents of the start-up time register should be decreased. If the motor manufacturer e.g. states that a maximum of three 60 s starts may be made with a motor within four hours, the setting $\sum t_{si}$ should be $3 \times 60 = 180$ s and the setting $\Delta \sum t_s = 180 \text{ s} / 4\text{h} = 45 \text{ s/h}$.</p>
Self-supervision	<p>The microprocessor technology used enables a self-supervision feature to be implemented in the relay. The supervision unit continuously monitors the condition of most of the important components in the relay as well as the cooperation of the microprocessor and the analog-to-digital converter hardware. The operation of the processor software is also monitored. If an incorrect operation is detected, the signal-</p>	<p>ling output relay is operated. This provides a means of avoiding conditions where the system could be operated without a proper protection. The output relay is normally energized, ensuring that an alarm is given also at a total loss of auxiliary power. If the fault condition permits it, the internal relay fault is indicated with a separate LED labelled "IRF" on the front panel.</p>

Block diagram

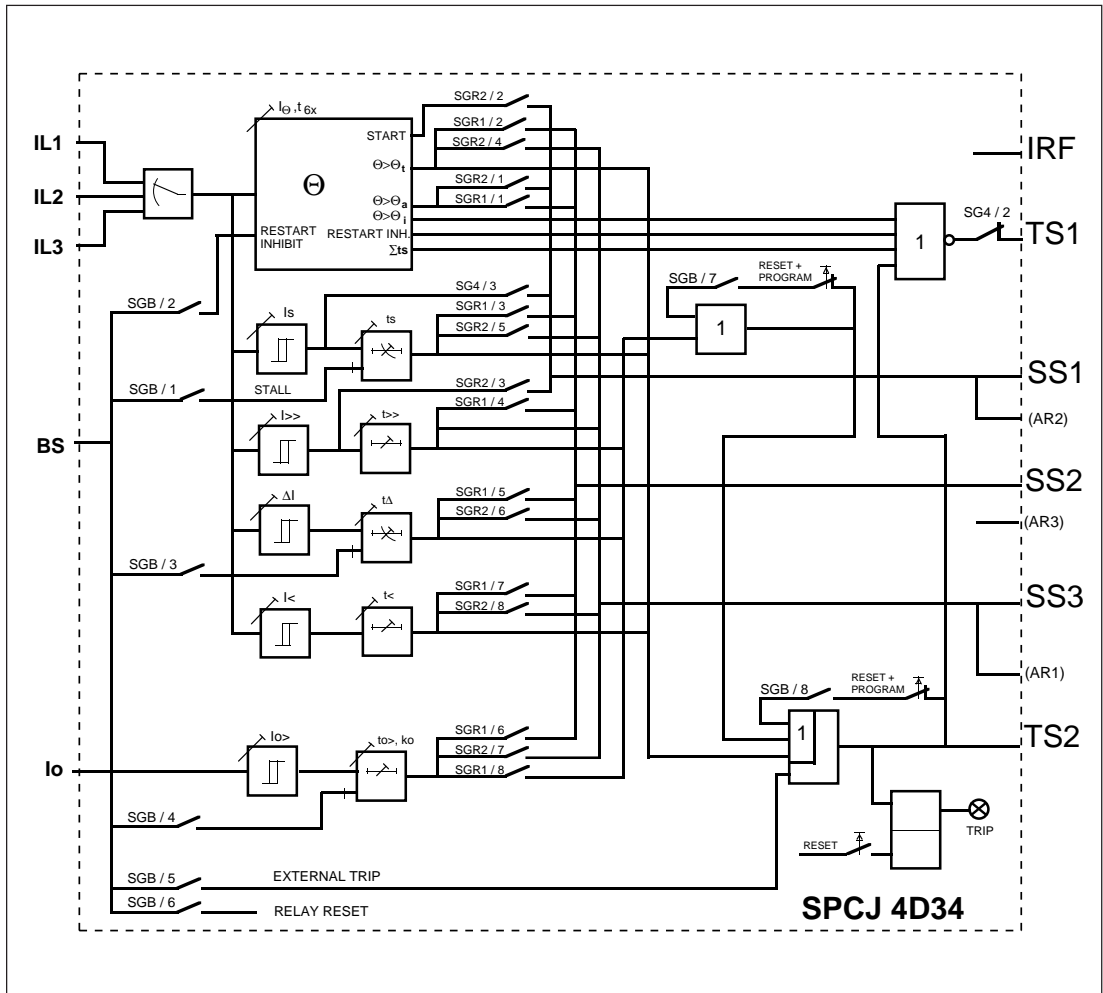

Fig. 6. Block diagram of the motor protection module SPCJ 4D34

- I_{L1}, I_{L2}, I_{L3} Phase currents
- I_0 Neutral current
- BS External control, blocking or resetting signal
- SGF Selector switchgroup SGF
- SGB Selector switchgroup SGB
- SGR1...2 Selector switchgroups SGR
- TS1 Restart enable signal
- SS1 Starting or prior alarm signal selected with switchgroup SGR2
- SS2 Prior alarm or trip signal 2 selected with switchgroup SGR1
- SS3 Trip signal 2 for stages selected with switchgroup SGR2
- TS2 Tripping signal selected with switchgroup SGR2
- AR1, AR2, AR3 Starting signals for external autoreclose unit (not used with motors!)
- TRIP Red indicator for tripping

Note!

All input and output signals of the module are not necessarily wired to the terminals of every relay unit using a particular module. The sig-

nals wired to the terminals are shown in the diagram illustrating the flow of signals between the protection modules of the relay unit.

Front panel

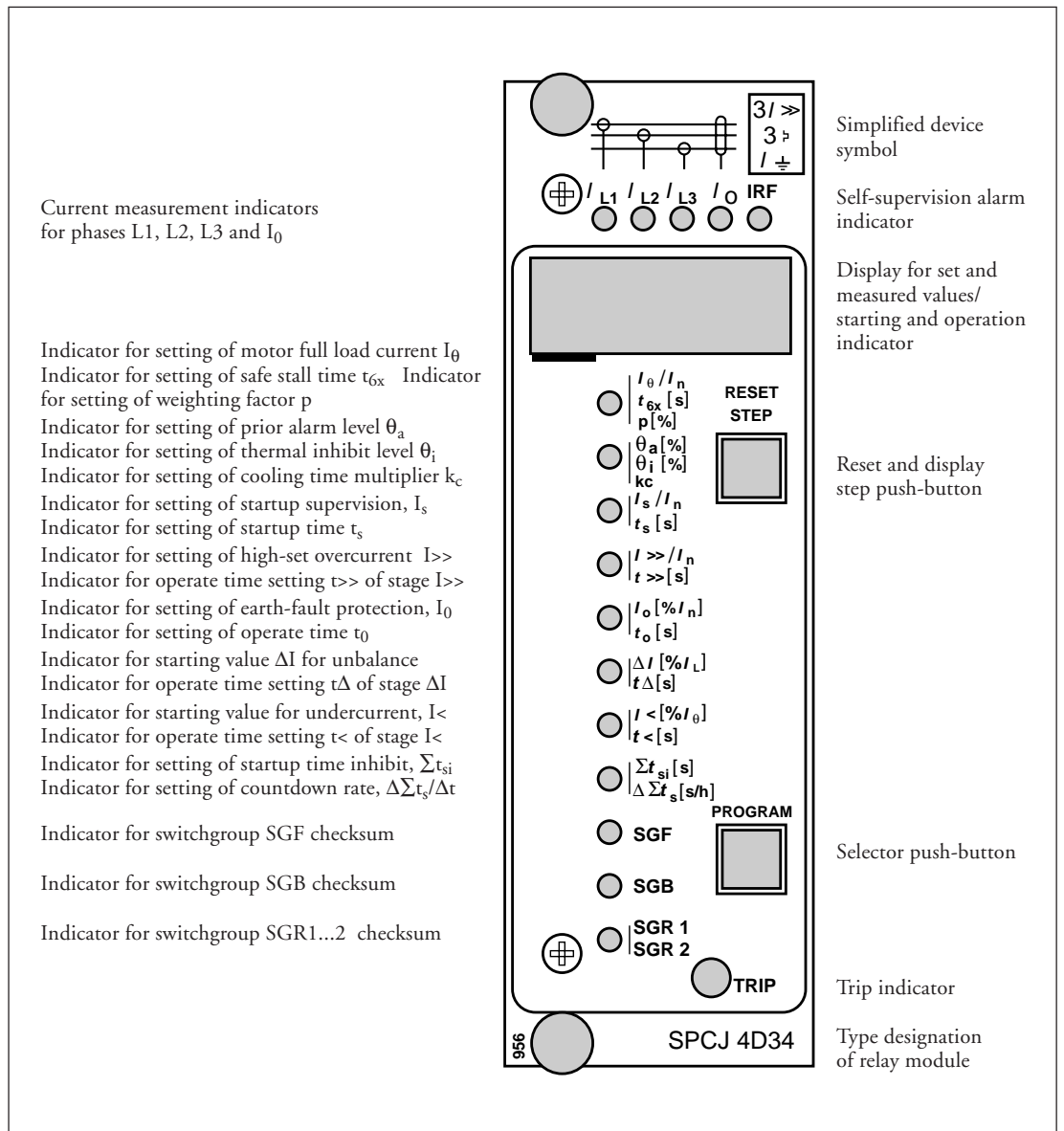

Fig. 7. Front panel of the motor protection relay module SPCJ 4D34

Operation indications

Each protective unit has its own operation indicator shown as a figure in the digital display. Further all stages share a common operation indicator named "TRIP", which indicates with red light that the module has delivered a tripping signal.

when the current stage resets, thus indicating which protection stage was operating. The operation indication is reset with the RESET push-button. The function of the protection module is not affected by an unreset operation indicator.

The operation indication in the display persists

The following table shows the starting and tripping indications and their meanings.

Indication	Explanation
1	$\theta > \theta_a$ = A prior alarm signal for a thermal overload has been given
2	$\theta > \theta_t$ = The thermal protection unit has tripped
3	$\theta > \theta_i, \Sigma t_{si},$ EINH = The thermal restart inhibit level is exceeded, the startup time counter is full or the external inhibit signal is active
4	$I >>$ = The high-set stage $I >>$ of the overcurrent unit has tripped
5	ΔI = The unbalance/incorrect phase sequence protection unit has tripped
6	$I_s^2 \times t_s$ = The start-up supervision unit has tripped
7	I_0 = The earth-fault unit has tripped
8	$I <$ = The undercurrent unit has tripped
9	EXT.TRIP = A trip from an external relay has been carried out via the relay

The self-supervision alarm indicator IRF indicates that the self-supervision system has detected a permanent fault. The indicator is lit with red light about one minute after the fault has been detected. At the same time the protection module delivers a signal to the self-supervision system output relay of the protection unit.

Additionally, in most fault cases, a fault code showing the nature of the fault appears on the display of the module. The fault code consists of a red figure one and a green code number. When a fault occurs, the fault code should be recorded and stated when ordering service.

Relay settings

The setting values are shown by the right-most three digits of the display. An indicator close to the setting value symbol shows which setting value group is presently indicated on the display.

Setting	Parameter	Setting range (Factory settings)
I_{θ}	Motor full load current I_{θ} as a multiple of the relay rated current I_n . Tripping will be carried out if the current exceeds the set value by more than 5% for an extended amount of time.	$0.50 \dots 1.50 \times I_n$
t_{6x}	Maximum safe stall time, i.e. operate time in seconds for a cold motor at six times the full load current I_{θ} .	2.0...120 s
p	Weighting factor for thermal unit curves	20...100% (50%)
θ_a	Prior alarm level for an approaching thermal overload in per cent of the trip level	50...100% of trip level
θ_i	Restart inhibit level for a thermal overload condition in per cent of the trip level	20...80% of trip level
k_c	Cooling reduction factor for a motor at standstill compared to the heating time constant	1...64 x heating t.c.
I_s	Motor start current setting as a multiple of the relay rated current I_n	$1.0 \dots 10.0 \times I_n$
t_s	Motor start time setting in seconds *)	0.3...80 s (2 s)
$I_{>>}$	High-set overcurrent unit setting as multiples of relay rated current I_n	$0.5 \dots 20 \times I_n$ and ∞
$t_{>>}$	High-set stage operate time in seconds	0.04...30 s
I_0	Start current setting I_0 for the earth-fault unit in per cent of the relay rated current I_n	$1.0 \dots 100\% I_n$
t_0	Operate time of the earth-fault unit to in seconds	0.05...30 s
ΔI	Setting ΔI for the unbalance protection in per cent of the highest phase current	$10 \dots 40\% I_L$ and ∞
t_{Δ}	Operate time at the starting level in seconds, inverse time Operate time for the incorrect phase sequence current protection	20...120 s < 1s
$I_{<}$	Starting value for the undercurrent unit in per cent of the motor full load current	$30 \dots 80\% I_{\theta}$ and off
$t_{<}$	Operate time of the undercurrent unit in seconds	2...600 s
Σt_{si}	Time-based start inhibit counter setting in seconds*)	5...500 s
$\Delta \Sigma t_s$	Countdown rate of the start time counter in seconds per hour	2...250 s/h
SGF SGB SGR	The checksums of the selector switchgroups SGF, SGB, SGR1 and SGR2 are indicated on the display when the indicators adjacent to the switchgroup symbols on the front panel are illuminated. The influence of the position of the different switches on the operation of the relay is described in separate paragraphs.	

*) Start-up is defined as a condition when the phase currents within less than 60 ms exceed a level $1.5 I_{\theta}$ from a standstill state $I < 0.12 I_{\theta}$. The start-up condition ends when the phase currents again go lower than $1.25 I_{\theta}$. For

the start-up stall protection unit, time counting is stopped when the speed switch changes its state, if the facility is in use. In this case the setting t_s should preferably be equal to the t_c time of the motor.

Programming switches

The additional functions required in various applications are selected by means of switchgroups SGF, SGB, SGR1 and SGR2 indicated on the front panel. Further, the motor protection relay module contains a software switch-

group SG4, which is located in submenu four of register A. The numbering of the switches, 1...8, and the switch positions 0 and 1 are indicated when setting the switchgroups. In normal service only the checksums are shown.

Functional programming switchgroup SGF

The selector switches of the switchgroup SGF are used to define certain functions of the relay and are identified as SGF/1 to SGF/8.

Switch	Function	Factory default	User settings	Weight value
SGF/1	High-set overcurrent unit inhibited or in use 0 = high-set stage inhibited (setting displayed "- - -") 1 = high-set stage in use	1		1
SGF/2	Setting of high-set overcurrent stage doubled during a motor start-up 0 = no doubling 1 = doubling feature active	1		2
SGF/3	Earth-fault trip inhibited on overcurrents higher than a selected multiple of the motor full load current FLC as follows:	0		4
SGF/4		0		8
		SGF/3 = 0	SGF/3 = 1	
		SGF/4 = 0	no inhibit	inhibit at four times FLC
	SGF/4 = 1	inhibit at six times FLC	inhibit at eight times FLC	
SGF/5	Selection or deselection of phase unbalance protection 0 = not in use (setting displayed "- - -") 1 = operative	1		16
SGF/6	Incorrect phase sequence protection inhibited or in use 0 = not in use 1 = operative	1		32
SGF/7	Stall protection based on the thermal stress supervision, $I_s^2 \times t_s$ or a definite time overcurrent function, I_s & t_s . 0 = definite time overcurrent; 1 = thermal stress monitoring	1		64
SGF/8	Selection or deselection of the undercurrent protection 0 = not in use (setting displayed "- - -") 1 = operative	0		128
Checksum for factory setting of SGF				115

Blocking and control input selector switchgroup SGB

The selector switches of the switchgroup SGB are used to define certain functions of the external control input of the relay and are identified as SGB/1 to SGB/8.

Switch	Function	Factory setting	Checksum value
SGB /1	Stall information to relay from speed switch on motor (1). This feature is mainly used for ExE-type motor drives where the motor must not be stalled for a time exceeding the motor start-up time.	0	1
SGB /2	Restart of the motor inhibited by external command (1). Can be used to tie the motor restart to an external automation equipment.	0	2
SGB /3	When SGB/3 = 1, the phase unbalance unit is blocked by the input signal BS. On deblocking, the unit operates with its normal operate time. Can be used e.g. to inhibit the operation during a start-up when the motor is connected to a soft-starter.	0	4
SGB /4	When SGB/4 = 1, the earth-fault unit is blocked by the input signal BS. On deblocking, the unit operates with its normal operating time. Can be used e.g. to avoid possible nuisance trippings during start-up due to a soft-starter or saturated C.T.s.	0	8
SGB/5	External trip command carried out to output relay A (1). External protective relays can be connected to the trip path using this feature. Note! The trip signalling is not handled by the SPCJ-module and must be arranged using a contact on the external protective relay.	0	16
SGB/6	External relay reset (1) makes it possible to have a manual master reset button outside the relay. The same button can serve all relays on a station. Another possibility is to link the reset to some automation.	0	32
SGB/7	Latching of output relay for short-circuit, earth-fault or unbalance trip. When SGB/7 = 0, the tripping signal returns to its initial state, i.e. the output relay drops off, when the measuring signal causing the operation falls below the starting level. When SGB/7 = 1, the tripping signal remains on, i.e. the output relay operated although the measuring signal falls below the starting level. Then the tripping signals have to be reset by pressing the PROGRAM push-button, by pressing the PROGRAM and RESET push-buttons simultaneously or by remote control over the SPA bus or the external control input.	0	64
SGB /8	Latching (1) of output relay for any tripping, independent of the cause. When SGB/8 = 0, the tripping signal returns to its initial state, i.e. the output relay drops off, when the measuring signal causing the operation falls below the starting level. When SGB/8 = 1, the tripping signal remains on, i.e. the output relay is energized, although the measuring signal falls below the starting level. The tripping signals have to be reset by pressing the PROGRAM push-button, by pressing the PROGRAM and RESET push-buttons simultaneously or by remote control over the SPA bus or the external control input.	0	128
Checksum for factory setting of SGB			0

The selector switches of the switchgroups SGR1 and SGR2 are used to route desired output signals to the corresponding output relays. The switches are identified as SGR1/1 ...SGR1/8 and SGR2/1...SGR2/8.

Selector switchgroup SGR 1

Switch	Function	Factory setting	Checksum value
1	When SGR1/1 = 1, the thermal prior alarm linked to SS2	1	1
2	When SGR1/2 = 1, the thermal trip signal linked to SS2	0	2
3	When SGR1/3 = 1, the signal from stall protection linked to SS2	0	4
4	When SGR1/4 = 1, the signal for high-set overcurrent linked to SS2	0	8
5	When SGR1/5 = 1, the signal for current unbalance linked to SS2	0	16
6	When SGR1/6 = 1, the signal for earth-fault linked to SS2	0	32
7	When SGR1/7 = 1, the signal for undercurrent linked to SS2	0	64
8	When SGR1/8 = 1, the earth-fault unit trip linked to TS2	1	128
Checksum for factory settings for SGR1			129

Selector switchgroup SGR 2

1	When SGR2/1 = 1, the thermal prior alarm linked to SS1	0	1
2	When SGR2/2 = 1, the motor start-up info output linked to SS1	1	2
3	When SGR2/3 = 1, the starting of the high-set overcurrent unit linked to SS1	0	4
4	When SGR2/4 = 1, the thermal trip signal linked to SS3	1	8
5	When SGR2/5 = 1, the signal from stall protection linked to SS3	1	16
6	When SGR2/6 = 1, the signal for current unbalance linked to SS3	1	32
7	When SGR2/7 = 1, the signal for earth-fault linked to SS3	1	64
8	When SGR2/8 = 1, the signal for undercurrent linked to SS3	1	128
Checksum for factory settings for SGR2			250

Switchgroup SG4

The software switchgroup SG4 contains three selector switches in the fourth submeny of register A.

Switch	Function	Factory setting	Checksum value
1	<p>Switch SG4/1 is used, when the $I_s^2 \times t_s$ principle has been selected for start-up supervision. (SGF/7 = 1)</p> <p>When SG4/1 = 0, the relay calculates the $I_s^2 \times t_s$ value in a starting situation. A starting situation is defined as a situation, where the phase currents increase from a value less than $0.12 I_\theta$ to a value exceeding $1.5 \times I_\theta$ within less than 60 ms. The starting situation ceases when the phase currents fall below $1.25 \times I_\theta$ for more than 100 ms.</p> <p>When SG4/1 = 1, the relay starts calculating the $I_s^2 \times t_s$ value when the start current I_s is exceeded.</p>	0	1
2	When SG4/2 = 1, the restart enable message TS1 is disabled.	0	2
3	When SG4/3 = 1, the start signal of the I_s stage is directly routed to output SS1.	0	4
Factory set default checksum of switchgroup SG4			0

Example of checksum calculation

The example below illustrates how the checksum of switchgroup SGF can be calculated manually:

Switch	Factor		Switch position		Value
SGF/1	1	x	1	=	1
SGF/2	2	x	0	=	0
SGF/3	4	x	1	=	4
SGF/4	8	x	0	=	0
SGF/5	16	x	0	=	0
SGF/6	32	x	0	=	0
SGF/7	64	x	1	=	64
SGF/8	128	x	0	=	+ 0
Switchgroup SGF checksum					69

When the checksum calculated according to the example is equal to the checksum indicated on the display of the relay module, the switches are properly set.

Measured data

The measured values are displayed by the three right-most digits of the display. The currently measured data are indicated by an illuminated LED indicator on the front panel.

Indicator	Measured data
I_{L1}	Line current on phase L1 as a multiple of the relay rated current I_n .
I_{L2}	Line current on phase L2 as a multiple of the relay rated current I_n .
I_{L3}	Line current on phase L3 as a multiple of the relay rated current I_n .
I_0	Neutral current expressed in per cent of the relay rated current I_n .

Recorded information

Any time the relay starts or performs a tripping, the current values at the moment of tripping, the duration of the starting for different units and other parameters are stored in a two place memory stack. A new operation moves the old values up to the second place and adds a new value to the first place of the stack consisting of registers 1...7. Two value pairs are memorized - if a third starting occurs, the oldest set of values will be lost. A master reset of the relay erases all the contents of both of the register blocks. The leftmost red digit displays the register address and the other three digits the recorded information. A symbol "/" in the text indicates that the following item is found in a submenu.

Register/STEP	Recorded information
1	Phase current I_{L1} measured as a multiple of the rated current of the overcurrent unit. // The duration of the starting of the I> unit in per cent of the operate time.
2	Phase current I_{L2} measured as a multiple of the rated current of the overcurrent unit. // The duration of the starting of the I>> unit in per cent of the operate time.
3	Phase current I_{L3} measured as a multiple of the rated current of the overcurrent unit. // The duration of the starting of the I< unit in per cent of the operate time.
4	Neutral current I_0 measured as a per cent of the rated current of the earth-fault unit. // The duration of the starting of the I_0 unit in per cent of the operate time.
5	Phase unbalance ΔI in percent of highest phase current. // The duration of the starting of the ΔI unit in per cent of the trip time.
6	Start-up thermal stress product $I_s^2 \times t_s$. // Motor start-up count. Cleared only by a power supply interrupt.
7	The thermal level I_θ at the end of the event, given in per cent of the trip level. // The thermal level I_θ at the beginning of the event, given in per cent of the trip level.
8	The actual value of the thermal capacity used. // The actual value of the phase unbalance.
9	The approximate time in minutes to a restart enabling of the motor if the motor is stopped. // The actual value of the cumulative start-up time counter, which is continuously decreased with a rate determined by the setting $\Delta \sum t / \Delta t$. // The motor start-up time memorized during the latest start-up. // Counter for the total amount of motor running hours expressed in hours x 100.

Register/ STEP	Recorded information																								
0	<p>Display of blocking signals and other external control signals.</p> <p>The rightmost digit indicates the state of the external control input of the unit. The following states may be indicated: 0 = no control / blocking signal 1 = the control or blocking signal BS is alert.</p> <p>The effect of the signal on the unit is determined by the setting of switchgroup SGB</p> <p>From the register "0" it is possible to move on to the TEST mode, where the alarm and tripping signals of the module are activated one by one in the following order and indicated by the flashing setting indication LED:</p> <table border="1" data-bbox="560 640 772 1155"> <tr> <td>●</td> <td>I_{tp} / I_n t_{6x} [s] p [%]</td> <td>Tripping caused by the thermal unit</td> </tr> <tr> <td>●</td> <td>θ_a [%] θ_i [%] kc</td> <td>Thermal unit prior alarm carried out</td> </tr> <tr> <td>●</td> <td>I_{st} / I_n ts [s]</td> <td>Trip from start-up supervision unit and start condition signal</td> </tr> <tr> <td>●</td> <td>I_{tr} / I_n tr [s]</td> <td>Trip from high-set overcurrent unit</td> </tr> <tr> <td>●</td> <td>I_o [%In] to [s]</td> <td>Trip from earth-fault unit</td> </tr> <tr> <td>●</td> <td>ΔI [%IL] tΔ [s]</td> <td>Trip from unbalance unit</td> </tr> <tr> <td>●</td> <td>I_{uc} [%I] tc [s]</td> <td>Trip from undercurrent unit</td> </tr> <tr> <td>●</td> <td>Σt_{si} [s] $\Delta \Sigma t_s$ [s/h]</td> <td>Restart inhibit from start-up time counter</td> </tr> </table> <p>The LED positions adjacent to SGF, SGB and SGR are not tied to any test function.</p> <p>For further details, see the description "General characteristics of D-type SPC relay modules".</p>	●	I_{tp} / I_n t_{6x} [s] p [%]	Tripping caused by the thermal unit	●	θ_a [%] θ_i [%] kc	Thermal unit prior alarm carried out	●	I_{st} / I_n ts [s]	Trip from start-up supervision unit and start condition signal	●	I_{tr} / I_n tr [s]	Trip from high-set overcurrent unit	●	I_o [%In] to [s]	Trip from earth-fault unit	●	ΔI [%IL] t Δ [s]	Trip from unbalance unit	●	I_{uc} [%I] tc [s]	Trip from undercurrent unit	●	Σt_{si} [s] $\Delta \Sigma t_s$ [s/h]	Restart inhibit from start-up time counter
●	I_{tp} / I_n t_{6x} [s] p [%]	Tripping caused by the thermal unit																							
●	θ_a [%] θ_i [%] kc	Thermal unit prior alarm carried out																							
●	I_{st} / I_n ts [s]	Trip from start-up supervision unit and start condition signal																							
●	I_{tr} / I_n tr [s]	Trip from high-set overcurrent unit																							
●	I_o [%In] to [s]	Trip from earth-fault unit																							
●	ΔI [%IL] t Δ [s]	Trip from unbalance unit																							
●	I_{uc} [%I] tc [s]	Trip from undercurrent unit																							
●	Σt_{si} [s] $\Delta \Sigma t_s$ [s/h]	Restart inhibit from start-up time counter																							
A	<p>The address code of the protection relay module, required by the serial communication system. // Data transfer rate of the serial communication. // The bus traffic monitor indicating the operation state of the serial communication system. If the module is connected to a system including the control data communicator type SACO 148D4 and if the communication system is operating, the counter reading of the bus traffic monitor will be zero. Otherwise the numbers 0...255 are continuously scrolling in the counter. // The password required for the remote control of settings. The password given in the setting mode of the next submenu step must always be entered via the serial communication before settings can be remotely altered. // Checksum of switchgroup SG4</p>																								
-	<p>Display dark. By pressing the STEP push-button the beginning of the display sequence is re-entered.</p>																								

The memorized values in registers 1...7 are erased by pressing the push-buttons RESET and PROGRAM simultaneously. The registers are also erased if the auxiliary power supply of the module is interrupted. The address code of the relay module, the data transfer rate of the serial

communication and the passwords are not erased by a voltage failure. The instructions for setting the address and the data transfer rate are described in the "General characteristics of D type SPC relay modules".

Main menus and submenus of settings and registers

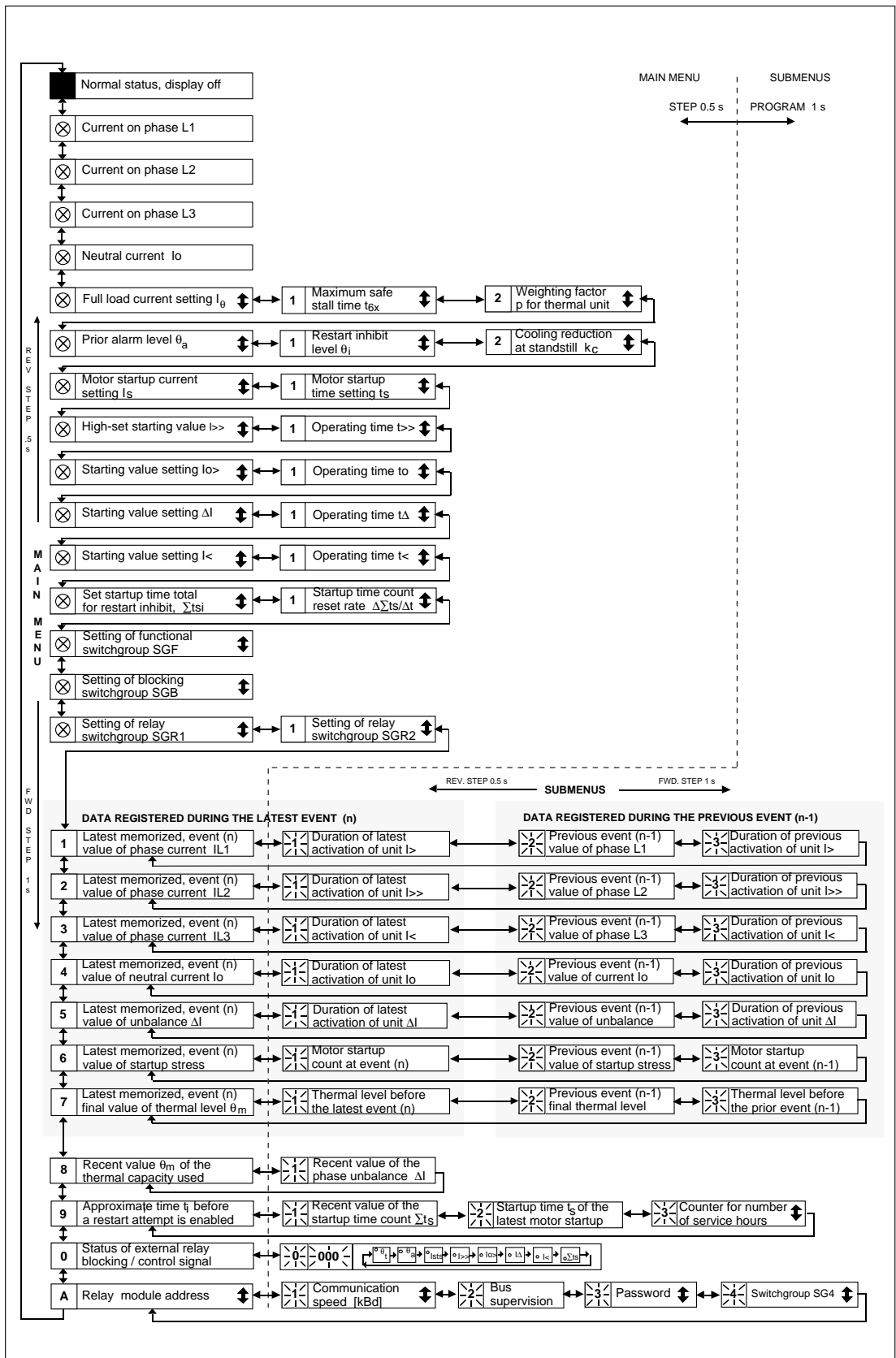



Fig. 8. Man-machine communication menu for the motor protection relay module SPCJ 4D34

The measures required for entering a submenu or a setting mode and how to perform the setting and use the TEST mode are described in detail on Data Sheet "General characteristics of the D-type SPC relay modules". A short form guide to the operations is shown below.

Desired step or programming operation	Push-button	Action
Forward step in main or submenu	STEP	Press for more than 0.5 s
Rapid forward scan in main menu	STEP	Keep depressed
Reverse step in main or submenu	STEP	Press less than about 0.5 s
Entering submenu from main menu	PROGRAM	Press for 1 s (Active on release)
Entering or leaving setting mode	PROGRAM	Press for 5 s
Increasing a value in setting mode	STEP	
Moving the cursor in setting mode	PROGRAM	Press for about 1 s
Storing a value in setting mode	STEP&PROGRAM	Press simultaneously
Resetting of memorized values	STEP&PROGRAM	Note! Operative outside setting mode
Resetting of latched output relays	PROGRAM	Press once, display must be off
Note! All parameters which can be set in a setting mode are indicated with the symbol  .		

Acknowledge and reset functions:

RESET clears the operation indications on the display.

PROGRAM clears the operation indications on the display and unlatches a latched output relay (corresponds to the command V101 over the SPA bus).

RESET & PROGRAM clears the operation indications on the display, unlatches a latched output relay and erases the recorded fault values from the memory (corresponds to the command V 102 over the SPA bus).

Technical data

Thermal overload unit

Motor full load current setting I_0	
Setting range	$0.50 \dots 1.50 \times I_n$
Setting resolution	$0.01 \times I_n$
Accuracy of current measurement	$\pm 2\%$
Safe stall time setting t_{6x} , operate time from cold state at $6 \times I_0$	
Setting range	2.0...120 s
Setting resolution as handled by algorithm	0.5 s
Time count increments for the thermal unit	0.5 s
Accuracy of timing functions	$\pm 2\%$ or ± 0.5 s
Cooling time multiplier k_c for motor at standstill, setting range	1...64 times heating time constant
Thermal prior alarm level θ_a , setting range	50...100% of thermal trip level θ_t
Restart inhibit level θ_i for thermal overload, setting range	20...80% of thermal trip level θ_t
Initialization of the thermal unit on connection of auxiliary supply, equal to motor hot state	70% x θ_t *)

Start-up supervision unit

Start-up current I_s , setting range	$1.0 \dots 10.0 \times I_n$
Start-up time t_s , setting range	0.3...80 s
When operating as definite time overcurrent relay: **)	
Reset time, typ.	50 ms
Drop-off / pick-up ratio, typ.	0.96
Operate time accuracy	$\pm 2\%$ of set value or ± 25 ms
Operation accuracy	$\pm 3\%$ of set value
When operating as start-up thermal stress relay: **)	
Reset time, typ.	200 ms
Operation accuracy	$\pm 10\%$ of set value $I_s^2 \times t_s$
Shortest possible operate time	about 300 ms

High-set overcurrent unit

Start current $I_{>>}$, setting range	$0.5 \dots 20.0 \times I_n$ or ∞ , infinite
Start time, typically	50 ms
Operate time setting range	0.04...30 s
Reset time, typ.	50 ms
Drop-off / pick-up ratio, typ.	0.96
Operate time accuracy	$\pm 2\%$ of set value or ± 25 ms
Operation accuracy	$\pm 3\%$ of set value

*) Note!

Due to this feature, low settings of the prior alarm level will always render a thermal prior alarm signal when the auxiliary supply is connected.

**) Note!

Both protection functions cannot be selected at the same time. The selection is carried out with switch SGF/7. In both cases the operation of the timing circuit can be interrupted with an external control signal fed to the relay's control input (SGB/1 = 1).

Earth-fault unit

Start current I_0 , setting range	1.0...100 % I_n
Start time, typ.	50 ms
Operate time setting range	0.05...30 s
Reset time, typ.	50 ms
Drop-off / pick-up ratio, typ.	0.96
Operate time accuracy	$\pm 2\%$ of set value or ± 25 ms
Operation accuracy	$\pm 3\%$ of set value $+0.0005 \times I_n$

Unbalance / phase reversal unit

Start current ΔI , setting range	10...40% I_L or ∞ , infinite
Operation time at lowest possible setting, 10 %	20...120 s, inverse time
Reset time, typ.	200 ms
Operate time accuracy	$\pm 20\%$ of theoretical value for $U/B > 20\%$, see Fig. 5
Operate time for a single phasing condition	1 s
Operate time at incorrect phase sequence	600 ms

Undercurrent unit

Starting value $I_<$, setting range	30...80% I_q or off
Operate time $t_<$, setting range	2...600 s
Reset time, typ.	200 ms
Drop-off / pick-up ratio, typ.	1.1

Start-up time counter unit

Restart inhibiting start count setting $\sum t_{si}$	5...500 s
Countdown rate of start-up time counter $\Delta \sum t_s / \Delta t$	2...250 s/h

Serial communication

Event codes

When the motor protection relay module SPCJ 4D34 is linked to the control data communicator SACO 148 D4 over the SPA bus, the module will provide spontaneous event markings e.g. to a printer. The events are printed out in the format: time, text which the user may have programmed into SACO148D4 and event code.

The codes E1...E32 and the events represented by these can be included in or excluded from the event reporting by writing event masks V155, V156, V157 and V158 to the module over the SPA bus. The event masks are binary numbers coded to decimal numbers. The event codes, e.g. E1...E8 are represented by the numbers 1, 2, 4...128. An event mask is formed by multiplying the above numbers either by 0, event not included in reporting, or 1, event included in reporting and adding up the numbers received, compare the procedure used in calculation of a checksum.

The event masks V155...V158 may have a value within range 0...255. The default values for the masks in the module SPCJ 4D34 are V155=80, V156=68, V157=68 and V158=20. The events selected by the default settings can be found in the list of events below.

The output signals are monitored by codes E33...E42 and the events represented by these can be included in or excluded from the event reporting by writing an event mask V159 to the module. The event mask is a binary number coded to a decimal number. The event codes E33...E42 are represented by the numbers 1, 2, 4...512. An event mask is formed by multiplying the above numbers either by 0, event not included in reporting or 1, event included in reporting and adding up the numbers received, compare the procedure used in calculation of a checksum.

The event mask V159 may have a value within the range 0...1023. The default value of the motor protection relay module SPCJ 4D34 is 768 which means that only the operations of the trip relay are included in the reporting.

The codes E50...E54 and the events represented by these cannot be excluded from the reporting.

More information about the serial communication over the SPA-bus can be found in the description "SPA bus communication protocol", 34 SPACOM 2 EN1.

Event codes of the motor protection relay module SPCJ 4D34:

Code	Event	Number representing the event	Default settings in the masks
E1	Beginning of motor start-up condition	1	0
E2	End of motor start-up condition	2	0
E3 *	Beginning of thermal overload condition	4	0
E4 *	End of thermal overload condition	8	0
E5	Start of thermal prior alarm	16	1
E6	Thermal prior alarm reset	32	0
E7	Tripping of thermal unit starting	64	1
E8	Tripping of thermal unit reset	128	0
	Default checksum for mask V155	80	
E9 *	Starting of stage $I_s >$	1	0
E10 *	Starting of stage $I_s >$ reset	2	0
E11	Tripping of stage $I_s >$ or $I_s^2 \times t_s$	4	1
E12	Tripping of stage $I_s >$ or $I_s^2 \times t_s$ reset	8	0
E13 *	Starting of $I >>$ stage	16	0
E14 *	Starting of $I >>$ stage reset	32	0
E15	Tripping of stage $I >>$	64	1
E16	Tripping of stage $I >>$ reset	128	0
	Default checksum for mask V156	68	

Code	Event	Number representing the event	Default settings in the masks
E17 *	Starting of stage I ₀ >	1	0
E18 *	Starting of stage I ₀ > reset	2	0
E19	Tripping of stage I ₀ >	4	1
E20	Tripping of stage I ₀ > reset	8	0
E21 *	Starting of ΔI stage	16	0
E22 *	Starting of ΔI stage reset	32	0
E23	Tripping of stage ΔI	64	1
E24	Tripping of stage ΔI reset	128	0
	Default checksum for mask V157	68	
E25 *	Starting of stage I<	1	0
E26 *	Starting of stage I< reset	2	0
E27	Tripping of stage I<	4	1
E28	Tripping of stage I< reset	8	0
E29	Beginning of external trip signal	16	1
E30	External trip signal reset	32	0
E31	Beginning of motor restart inhibit	64	0
E32	End of motor restart inhibit	128	0
	Default checksum for mask V158	20	
E33	Output signal TS1 activated	1	0
E34	Output signal TS1 reset	2	0
E35	Output signal SS1 activated	4	0
E36	Output signal SS1 reset	8	0
E37	Output signal SS2 activated	16	0
E38	Output signal SS2 reset	32	0
E39	Output signal SS3 activated	64	0
E40	Output signal SS3 reset	128	0
E41	Output signal TS2 activated	256	1
E42	Output signal TS2 reset	512	1
	Default checksum for mask V159	768	
E50	Restarting	-	®
E51	Overflow of event register	-	®
E52	Temporary interruption in data communication	-	®
E53	No response from the module over the data communication	-	®
E54	The module responds again over the data communication	-	®
0	not included in the event reporting	-	no code number
1	included in the event reporting	®	cannot be programmed

E52...E54 are generated by SACO 100M or SRIO 500M/1000M

* Note!

During a motor start-up (E1-E2) the event codes for starting of protective units, marked with an asterisk in the table, are not transmitted.

Remote transfer data In addition to the spontaneous data transfer the SPA bus allows reading of all input data (I-data) of the module, setting values (S-values), information recorded in the memory (V-data), and some other data. Further, part of the data can be altered by commands given over the SPA bus. All the data are available in channel 0.

Data	Code	Data flow direction	Value range
INPUTS			
Measured current on phase L1	I1	R	0...63 x I_n
Measured current on phase L2	I2	R	0...63 x I_n
Measured current on phase L3	I3	R	0...63 x I_n
Measured neutral current	I4	R	0...210 % I_n
Blocking or control signal	I5	R	0 = no blocking 1 = external blocking or control signal active
OUTPUTS			
Starting of stage I_0	O1	R	0 = I_0 stage not started 1 = I_0 stage started
Thermal prior alarm	O2	R	0 = I_0 alarm active 1 = I_0 alarm reset
Tripping of stage I_0	O3	R	0 = I_0 stage not tripped 1 = I_0 stage tripped
Starting of stage $I_{s>}$ or $I_s^2 \times t_s$	O4	R	0 = $I_{s>}$ or $I_s^2 \times t_s$ stage not started 1 = $I_{s>}$ or $I_s^2 \times t_s$ stage started
Tripping of stage $I_{s>}$ or $I_s^2 \times t_s$	O5	R	0 = $I_{s>}$ or $I_s^2 \times t_s$ stage not tripped 1 = $I_{s>}$ or $I_s^2 \times t_s$ stage tripped
Starting of stage $I_{>>}$	O6	R	0 = $I_{>>}$ stage not started 1 = $I_{>>}$ stage started
Tripping of stage $I_{>>}$	O7	R	0 = $I_{>>}$ stage not tripped 1 = $I_{>>}$ stage tripped
Starting of stage $I_{0>}$	O8	R	0 = $I_{0>}$ stage not started 1 = $I_{0>}$ stage started
Tripping of stage $I_{0>}$	O9	R	0 = $I_{0>}$ stage not tripped 1 = $I_{0>}$ stage tripped
Starting of stage ΔI	O10	R	0 = ΔI stage not started 1 = ΔI stage started
Tripping of stage ΔI	O11	R	0 = ΔI stage not tripped 1 = ΔI stage tripped
Starting of stage $I_{<}$	O12	R	0 = $I_{<}$ stage not started 1 = $I_{<}$ stage started
Tripping of stage $I_{<}$	O13	R	0 = $I_{<}$ stage not tripped 1 = $I_{<}$ stage tripped
External trip signal	O14	R	0 = signal not active 1 = signal active
External restart inhibit signal	O15	R	0 = inhibit not active 1 = inhibit active
RESTART ENABLE output TS1	O16	R	0 = signal not active 1 = signal active
START output SS1	O17	R, W (P)	0 = signal not active 1 = signal active
SIGNAL 2 output SS2	O18	R, W (P)	0 = signal not active 1 = signal active
SIGNAL1 output SS3	O19	R, W (P)	0 = signal not active 1 = signal active
TRIP output TS2	O20	R, W (P)	0 = signal not active 1 = signal active

Data	Code	Data flow direction	Value range
Operating of output relays	O21	R, W (P)	0 = not operated 1 = operated
Restart enable output control	O22	W(P)	0 = not affecting restart enable 1 = restart remotely inhibited
Memorized starting of stage I_0	O31	R	0 = I_0 stage not started 1 = I_0 stage started
Memorized thermal prior alarm	O32	R	0 = I_0 alarm active 1 = I_0 alarm reset
Memorized tripping of stage I_0	O33	R	0 = I_0 stage not tripped 1 = I_0 stage tripped
Memorized starting of stage $I_{s>}$ or $I_{s^2} \times t_s$	O34	R	0 = $I_{s>}$ or $I_{s^2} \times t_s$ stage not started 1 = $I_{s>}$ or $I_{s^2} \times t_s$ stage started
Memorized tripping of stage $I_{s>}$ or $I_{s^2} \times t_s$	O35	R	0 = $I_{s>}$ or $I_{s^2} \times t_s$ stage not tripped 1 = $I_{s>}$ or $I_{s^2} \times t_s$ stage tripped
Memorized starting of stage $I_{>>}$	O36	R	0 = $I_{>>}$ stage not started 1 = $I_{>>}$ stage started
Memorized tripping of stage $I_{>>}$	O37	R	0 = $I_{>>}$ stage not tripped 1 = $I_{>>}$ stage tripped
Memorized starting of stage $I_{0>}$	O38	R	0 = $I_{0>}$ stage not started 1 = $I_{0>}$ stage started
Memorized tripping of stage $I_{0>}$	O39	R	0 = $I_{0>}$ stage not tripped 1 = $I_{0>}$ stage tripped
Memorized starting of stage ΔI	O40	R	0 = ΔI stage not started 1 = ΔI stage started
Memorized tripping of stage ΔI	O41	R	0 = ΔI stage not tripped 1 = ΔI stage tripped
Memorized starting of stage $I_{<}$	O42	R	0 = $I_{<}$ stage not started 1 = $I_{<}$ stage started
Memorized tripping of stage $I_{<}$	O43	R	0 = $I_{<}$ stage not tripped 1 = $I_{<}$ stage tripped
Memorized external trip signal	O44	R	0 = signal not active 1 = signal active
Memorized external restart inhibit signal	O45	R	0 = inhibit not active 1 = inhibit active
Memorized output signal TS1	O46	R	0 = signal not active 1 = signal active
Memorized output signal SS1	O47	R	0 = signal not active 1 = signal active
Memorized output signal SS2	O48	R	0 = signal not active 1 = signal active
Memorized output signal SS3	O49	R	0 = signal not active 1 = signal active
Memorized output signal TS2	O50	R	0 = signal not active 1 = signal active
Memorized output ENA-signal	O51	R	0 = signal not active 1 = signal active

Data	Code	Data flow direction	Value range
SETTING VALUES			
Thermal trip current setting I_{θ}	S1	R, W (P)	0.5...1.50 x I_n
Thermal unit stall time setting t_{6x}	S2	R, W (P)	2.0...120 s
Weighting factor p of the thermal unit	S3	R, W (P)	20...100 %
Thermal prior alarm level setting θ_a	S4	R, W (P)	50...100 % of trip level
Restart inhibit level setting θ_i	S5	R, W (P)	20...80 % of trip level
Cooling time multiplier setting k_c	S6	R, W (P)	1...64
Starting value of the I_s or $I_s^2 \times t_s$ unit	S7	R, W (P)	1.0...10.0 x I_n
Operate time t_s of the I_s or $I_s^2 \times t_s$ unit	S8	R, W (P)	0.3...80 s
Starting value of stage I>>	S9	R, W (P)	0.5...20.0 x I_n 999 = not in use (∞)
Operate time of stage I>>	S10	R, W (P)	0.04...30 s
Starting value of stage $I_{0>}$	S11	R, W (P)	1.0...100 % I_n
Operate time of stage $I_{0>}$	S12	R, W (P)	0.05...30 s
Starting value of stage ΔI	S13	R, W (P)	10...40 % I_L 999 = not in use (∞)
Basic operate time of stage ΔI	S14	R, W (P)	20...120 s
Starting value of stage I<	S15	R, W (P)	30...80 % I_{θ} 999 = not in use (∞)
Operate time of stage I<	S16	R, W (P)	2.0...600 s
Setting of time-based start inhibit	S17	R, W (P)	5...500 s
Setting of count-down rate	S18	R, W (P)	2...250 s/h
Checksum of switchgroup SGF	S19	R, W (P)	0...255
Checksum of switchgroup SGB	S20	R, W (P)	0...255
Checksum of switchgroup SGR1	S21	R, W (P)	0...255
Checksum of switchgroup SGR2	S22	R, W (P)	0...255
Checksum of switchgroup SG4	S23	R, W (P)	0...7

RECORDED AND MEMORIZED PARAMETERS

Current in phase L1 at starting or tripping	V21 & V41	R	0...63 x I_n
Current in phase L2 at starting or tripping	V22 & V42	R	0...63 x I_n
Current in phase L3 at starting or tripping	V23 & V43	R	0...63 x I_n
Neutral current I_0 at starting or tripping	V24 & V44	R	0...210 % I_n
Phase unbalance ΔI at starting or tripping	V25 & V45	R	0...100 %
Calculated value from start-up supervision	V26 & V46	R	0...100 %
Thermal level at trip instant	V27 & V47	R	0...100 %
Duration of activation of unit $I_{s>}$	V28 & V48	R	0...100 %
Duration of starting of unit I>>	V29 & V49	R	0...100 %
Duration of starting of unit I<	V30 & V50	R	0...100 %
Duration of starting of unit I_0	V31 & V51	R	0...100 %
Duration of starting of unit ΔI	V32 & V52	R	0...100 %
Motor start-up counter value n	V33 & V53	R	0...999
Thermal level at beginning of event	V34 & V54	R	0...100 %

Data	Code	Data flow direction	Value range
Actual thermal level	V1	R,W(P)	0...106 %
Actual unbalance level	V2	R	0...100 %
Estimated time to enabling of motor restart	V3	R	0...999 min
Actual reading of the cumulative start-up time counter	V4	R	0...999 s
Start-up time for latest motor start-up	V5	R	0...100 s
Phase conditions during trip *)	V6	R	1 = I _{sL3} , 2 = I _{sL2} , 4 = I _{sL1} , 8 = I _{0>} , 16 = I _{L3>>} , 32 = I _{L2>>} , 64 = I _{L1>>} 128 = not used
Operation indicator	V7	R	0...9
Motor running hour counter	V8	R, W(P)	0...999 x100 h

*) Code numbers 1, 2 and 4 are not in use, when the relay calculates the $I_s^2 \times t_s$ value only during the start-up situation (SGF/7 = 1 and SG4/1 = 0).

CONTROL PARAMETERS

Resetting of output relays at self-holding	V101	W	1 = output relays are reset
Resetting of output relays and recorded data	V102	W	1 = output relays and registers are reset
Event mask word for motor start-up or thermal overload events	V155	R, W	0...255, see section event codes
Event mask word for overcurrent / start-up supervision or short-circuit events	V156	R, W	0...255, see section event codes
Event mask word for earth-fault or unbalance events	V157	R, W	0...255, see section event codes
Event mask word for underload or externally controlled events	V158	R, W	0...255, see section event codes
Event mask word for output signal events	V159	R, W	0...1023, see section event codes
Opening of password for remote settings	V160	W	1...999
Changing or closing of password for remote settings	V161	W (P)	0...999
Activating of self-supervision input	V165	W	1 = self-supervision input is activated and IRF LED turned on
Factory final test	V167	W (P)	2 = format EEPROM and switch power on and off
Internal error code	V169	R	1...255
Data communication address of the module	V200	R, W	1...254
Data transfer rate	V201	R, W	4800 or 9600 Bd (R) 4.8 or 9.6 kBd (W)
Programme version symbol	V205	R	043 _

Data	Code	Data flow direction	Value range
Event register reading	L	R	time, channel number and event code
Re-reading of event register	B	R	time, channel number and event code
Type designation of the module	F	R	SPCJ 4D34
Reading of module status data	C	R	0 = normal state 1 = module been subject to automatic reset 2 = overflow of event regist. 3 = events 1 and 2 together
Resetting of module state data	C	W	0 = resetting
Time reading and setting	T	R, W	00.000...59.999 s

R = data to be read from the module
W = data to be written to the module
(P) = writing enabled by a password

The event register can be read by L command only once. Should a fault occur e.g. in the data transfer, the contents of the event register may be re-read using the B command. When required, the B command can be repeated. Generally, the control data communicator SACO 100M reads the event data and forwards them to the output device continuously. Under normal conditions the event register of the module is empty. In the same way SACO 100M resets abnormal status data, so this data is normally zero.

The setting values S1...S23 are the setting values used by the protection programs. All the settings can be read or written. A condition for writing is that remote set password has been opened.

When changing settings, the relay unit will check that the variables are not given out of range values as specified in the technical data of the module. If an out of range value is given to the module, either manually or by remote setting, the module will not perform the store operation, but will keep the previous setting.

Fault codes

A short time after the internal self-supervision system has detected a permanent relay fault the red IRF indicator is switched on and the output relay of the self-supervision system operates. Further, in most fault situations an autodiagnostic fault code is shown in the display. The fault code is composed of a red figure

1 and a green code number which indicates what may be the fault type. When a fault code appears on the display, the code number should be recorded on a piece of paper and given to the authorized repair shop when overhaul is ordered. Below is a list of some of the fault codes that might appear with the unit SPCJ 4D34:

Fault code	Type of error in module
4	Trip relay path broken or output relay card missing
30	Faulty program memory (ROM)
50	Faulty work memory (RAM)
51	Parameter memory (EEPROM) block 1 faulty
52	Parameter memory (EEPROM) block 2 faulty
53	Parameter memory (EEPROM) blocks 1 and 2 faulty
54	Parameter memory (EEPROM) blocks 1 and 2 faulty with different checksums
56	Parameter memory (EEPROM) key faulty. Format by writing a "2" to variable V167
195	Too low value in reference channel with multiplier 1
131	Too low value in reference channel with multiplier 5
67	Too low value in reference channel with multiplier 25
203	Too high value in reference channel with multiplier 1
139	Too high value in reference channel with multiplier 5
75	Too high value in reference channel with multiplier 25
252	Faulty hardware filter on E/F channel
253	No interruptions from the A/D-converter



ABB Oy, Distribution Automation
P.O. Box 699
FIN-65101 VAASA Finland
Tel. +358 10 22 11
Fax. +358 10 22 41094
www.abb.com/substationautomation

ABB Limited, Distribution Automation
Maneja, Vadodara - 390013, India
Tel. +91 265 260 4386
Fax. +91 265 263 8922
www.abb.com/substationautomation