

X64 Xcelera-CL PX4™

User's Manual
Edition 2.20

sensors | cameras | **frame grabbers** | processors | software | vision solutions

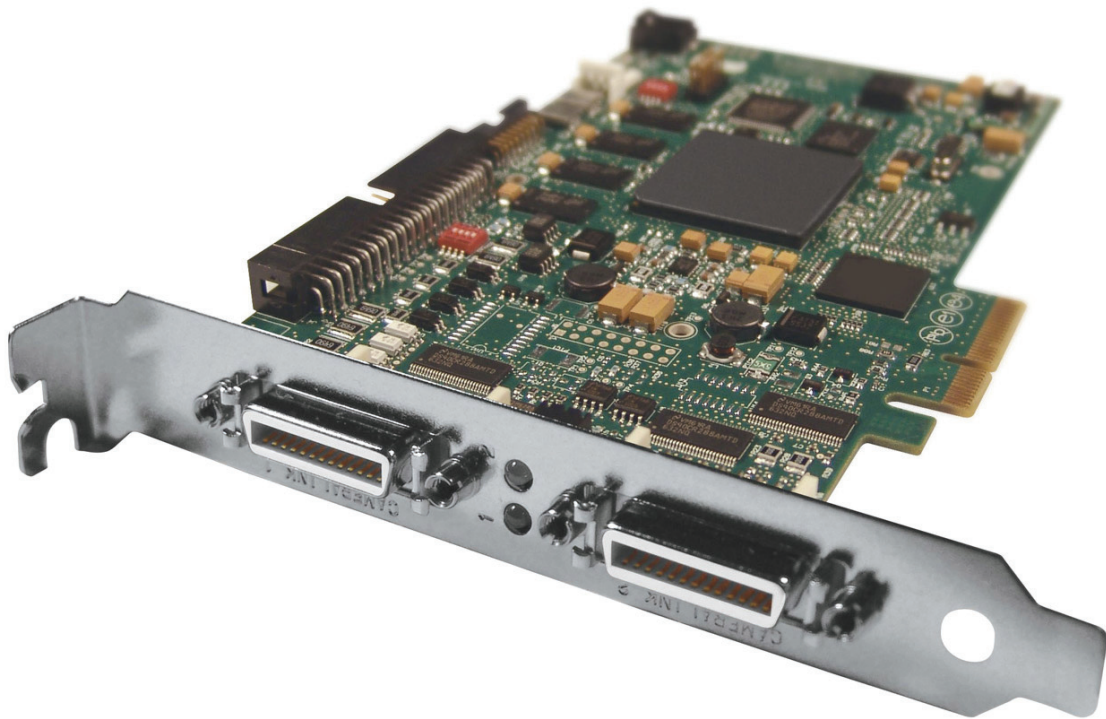

P/N: OC-X4CM-PUSR0
www.teledynedalsa.com

 **TELEDYNE DALSA**
Everywhere you look™

NOTICE

© 2014 Teledyne DALSA Corp. All rights reserved.

This document may not be reproduced nor transmitted in any form or by any means, either electronic or mechanical, without the express written permission of Teledyne DALSA . Every effort is made to ensure the information in this manual is accurate and reliable. Use of the products described herein is understood to be at the user's risk. Teledyne DALSA assumes no liability whatsoever for the use of the products detailed in this document and reserves the right to make changes in specifications at any time and without notice.

Microsoft® is a registered trademark; Windows®, Windows® XP, Windows® Vista, Windows® 7, Windows® 8 are trademarks of Microsoft Corporation.

All other trademarks or intellectual property mentioned herein belong to their respective owners.

Edition 2.20 released on: April 16, 2014

Document Number: OC-X4CM-PUSR0

Printed in Canada

About Teledyne DALSA

Teledyne DALSA is an international high performance semiconductor and electronics company that designs, develops, manufactures, and markets digital imaging products and solutions, in addition to providing wafer foundry services.

Teledyne DALSA Digital Imaging offers the widest range of machine vision components in the world. From industry-leading image sensors through powerful and sophisticated cameras, frame grabbers, vision processors and software to easy-to-use vision appliances and custom vision modules.

Contents

OVERVIEW	5
PRODUCT PART NUMBERS	5
ABOUT THE X64 XCELERA-CL PX4 FRAME GRABBER	6
<i>Series Key Features</i>	6
<i>User Programmable Configurations</i>	6
<i>ACUPlus: Acquisition Control Unit</i>	7
<i>DTE: Intelligent Data Transfer Engine</i>	7
<i>Advanced Controls Overview</i>	8
ABOUT THE OPTIONAL X-I/O MODULE	8
DEVELOPMENT SOFTWARE OVERVIEW	8
<i>Sapera++ LT Library</i>	8
<i>Sapera Processing Library</i>	8
INSTALLING X64 XCELERA-CL PX4	9
WARNING! (GROUNDING INSTRUCTIONS)	9
INSTALLATION	9
<i>Sapera LT Library Installation</i>	10
<i>X64 Xcelera-CL PX4 Driver Installation</i>	10
<i>X64 Xcelera-CL PX4 Firmware Loader</i>	10
Firmware Update: Automatic Mode	10
Firmware Update: Manual Mode	11
Executing the Firmware Loader from the Start Menu	11
REQUIREMENTS FOR A SILENT INSTALL	12
<i>Silent Mode Installation</i>	12
Creating a Response File	12
Running a Silent Mode Installation	12
<i>Silent Mode Uninstall</i>	13
Creating a Response File	13
Running a Silent Mode Uninstall	13
<i>Silent Mode Installation Return Code</i>	13
<i>Installation Setup with CorAppLauncher.exe</i>	13
<i>Custom Driver Installation using install.ini</i>	14
Creating the install.ini File	14
Run the Installation using install.ini	14
UPGRADING SAPERA OR ANY BOARD DRIVER	15
<i>Board Driver Upgrade Only</i>	15
<i>Sapera and Board Driver Upgrades</i>	15
USING THE CAMERA LINK SERIAL CONTROL PORT	16
<i>COM Port Assignment</i>	16
<i>Setup Example with Windows XP HyperTerminal</i>	17
DISPLAYING X64 XCELERA-CL PX4 BOARD INFORMATION	17
<i>Device Manager – Board Viewer</i>	17
CONFIGURING SAPERA.....	18
<i>Viewing Installed Sapera Servers</i>	18
<i>Increasing Contiguous Memory for Sapera Resources</i>	18
<i>Contiguous Memory for Sapera Messaging</i>	19
TROUBLESHOOTING PROBLEMS	20
OVERVIEW	20

PROBLEM TYPE SUMMARY	20
<i>First Step: Check the Status LED</i>	20
<i>Possible Installation Problems</i>	20
<i>Possible Functional Problems</i>	21
TROUBLESHOOTING PROCEDURES	21
<i>Checking for PCI Bus Conflicts</i>	21
<i>Windows Device Manager</i>	22
<i>GEN2 PCI Slot Computer Issue</i>	23
<i>BSOD (blue screen) Following a Board Reset</i>	23
<i>Sapera and Hardware Windows Drivers</i>	23
<i>Recovering from a Firmware Update Error</i>	23
<i>Driver Information via the Device Manager Program</i>	24
Information Window	24
<i>Teledyne DALSA Log Viewer</i>	25
<i>On-board Image Memory Requirements for Acquisitions</i>	25
<i>Symptoms: CamExpert Detects no Boards</i>	25
Troubleshooting Procedure	25
<i>Symptoms: X64 Xcelera-CL PX4 Does Not Grab</i>	26
<i>Symptoms: Card grabs black</i>	26
<i>Symptoms: Card acquisition bandwidth is less than expected</i>	26
CAMEXPERT QUICK START	27
INTERFACING CAMERAS WITH CAMEXPERT	27
<i>CamExpert Example with a Monochrome Camera</i>	27
CAMEXPERT DEMONSTRATION AND TEST TOOLS	28
CAMERA TYPES & FILES APPLICABLE TO THE X64 XCELERA-CL PX4.....	28
<i>Overview of Sapera Acquisition Parameter Files (*.ccf or *.cca/*.cvi)</i>	29
<i>Camera Interfacing Check List</i>	30
USING THE FLAT FIELD CORRECTION TOOL	30
<i>X64 Xcelera-CL PX4 Flat Field Support</i>	30
<i>Set up Dark and Bright Acquisitions with the Histogram Tool</i>	30
Verify a Dark Acquisition	30
Verify a Bright Acquisition	31
<i>Flat Field Correction Calibration Procedure</i>	32
<i>Using Flat Field Correction</i>	33
USING THE BAYER FILTER TOOL	33
<i>Bayer Filter White Balance Calibration Procedure</i>	34
<i>Using the Bayer Filter</i>	34
SAPERA DEMO APPLICATIONS	35
GRAB DEMO OVERVIEW	35
<i>Using the Grab Demo</i>	35
FLAT-FIELD DEMO OVERVIEW	36
<i>Using the Flat Field Demo</i>	36
X64 XCELERA-CL PX4 REFERENCE	37
FULL BLOCK DIAGRAM	37
ACQUISITION TIMING	38
LINE TRIGGER SOURCE SELECTION FOR LINESCAN APPLICATIONS	39
<i>CORACQ_PRM_EXT_LINE_TRIGGER_SOURCE</i>	39
SHAFT ENCODER INTERFACE TIMING.....	40
VIRTUAL FRAME TRIGGER FOR LINES SCAN CAMERAS	42
Synchronization Signals for a Virtual Frame of 10 Lines.	42
ACQUISITION METHODS	43
TRIGGER TO IMAGE RELIABILITY	43
<i>Supported Events and Transfer Methods</i>	44
Trigger Signal Validity	45
Supported Transfer Cycling Methods	45
OUTPUT LUT AVAILABILITY	46

SUPPORTING NON-STANDARD CAMERA LINK CAMERAS	47
<i>Firmware: Full with Bayer Decoder Method 6</i>	47
X64 XCELERA-CL PX4 SUPPORTED PARAMETERS	47
<i>Camera Related Capabilities</i>	47
<i>Camera Related Parameters</i>	48
<i>VIC Related Parameters</i>	51
<i>ACQ Related Parameters</i>	55
WINDOWS EMBEDDED 7 INSTALLATION	56
SAPERA SERVERS & RESOURCES	57
SERVERS AND RESOURCES	57
TECHNICAL SPECIFICATIONS	58
X64 XCELERA-CL PX4 BOARD SPECIFICATIONS.....	58
HOST SYSTEM REQUIREMENTS	60
EMI CERTIFICATIONS.....	61
CONNECTOR AND SWITCH LOCATIONS.....	62
<i>X64 Xcelera-CL PX4 Board Layout Drawing</i>	62
<i>Connector, Switch, Jumper Description List</i>	62
CONNECTOR AND SWITCH SPECIFICATIONS.....	63
<i>X64 Xcelera-CL PX4 End Bracket Detail</i>	63
<i>Configuration Micro-switches</i>	63
SW1: General Inputs Signal Switch Point.....	64
SW2: Trigger Inputs Signal Switch Point.....	64
SW3: Normal/Safe Boot Mode & GEN2 Slot Workaround	64
SW3-1 Boot Mode Details	64
SW3-2 GEN2 Slot Workaround Details	64
<i>Status LEDs Functional Description</i>	65
<i>J2: Camera Link Connector 1</i>	66
<i>J3: Camera Link Connector 2</i>	67
<i>Camera Link Camera Control Signal Overview</i>	68
<i>J4: External Signals Connector</i>	69
Note 1: General Inputs Specifications.....	69
Note 2: General Outputs Specifications.....	70
Note 3: External Trigger Input Specifications.....	71
Note 4: Shaft Encoder Input Specifications	72
Note 5: Strobe Output Specifications.....	73
Note 6: DC Power Details & J7	74
<i>External Signals Connector Bracket Assembly (Type 1)</i>	74
External Signals Connector Bracket Assembly (Type 1) Drawing.....	74
External Signals Connector Bracket Assembly (Type 1) Pinout	75
<i>External Signals Connector Bracket Assembly (Type 2)</i>	76
External Signals Connector Bracket Assembly (Type 2) Drawing.....	76
External Signals Connector Bracket Assembly (Type 2) Pinout	76
<i>J9: Board Sync</i>	77
CAMERA LINK INTERFACE	78
CAMERA LINK OVERVIEW.....	78
<i>Rights and Trademarks</i>	78
DATA PORT SUMMARY	78
CAMERA SIGNAL SUMMARY	79
Video Data	79
Camera Controls	79
Communication	79
CAMERA LINK CABLES	79
APPENDIX: X-I/O MODULE OPTION	80
X-I/O MODULE OVERVIEW	80
<i>X-I/O Module Connector List & Locations</i>	80

X-I/O MODULE INSTALLATION	81
<i>Board Installation</i>	81
<i>X64 Xcelera-CL PX4 and X-I/O Driver Update</i>	81
X-I/O MODULE EXTERNAL CONNECTIONS TO THE DB37	81
<i>DB37 Pinout Description</i>	82
<i>Outputs in NPN Mode: Electrical Details</i>	82
<i>Outputs in PNP Mode: Electrical Details</i>	83
<i>Opto-coupled Input: Electrical Details</i>	84
<i>TTL Input Electrical Details</i>	84
X-I/O MODULE SAPERA INTERFACE	85
<i>Configuring User Defined Power-up I/O States</i>	85
<i>Using Sapera LT General I/O Demo</i>	86
<i>Sapera LT General I/O Demo Code Samples</i>	87
Main I/O Demo code.....	87
Function CreateObjects().....	88
Output Dialog: CGioOutputDlg class (see Sapera Gui class).....	88
Input Dialog: CGioInputDialog class. (see Sapera Gui class)	89
I/O Event Handling	89
CONTACT INFORMATION	90
SALES INFORMATION.....	90
TECHNICAL SUPPORT.....	91
GLOSSARY OF TERMS	92
INDEX	94

Overview

Product Part Numbers

X64 Xcelera-CL PX4 Board

Item	Product Number
X64 Xcelera-CL PX4 Full with 128 MB of memory X64 Xcelera-CL PX4 Dual with 128 MB of memory	OR-X4C0-XPFO0 OR-X4C0-XPDO0
X-I/O Module (optional): provides an additional 8 input & 8 output general I/Os (see "Appendix: X-I/O Module Option" on page 80)	OC-IO01-STD00
For OEM clients, this manual in printed form, is available on request	OC-X4CM-USER0

X64 Xcelera-CL PX4 Software

Item	Product Number
Sapera LT version 6.00 or later (7.40 for Windows Vista, Windows 7, or Windows 8) — required but sold separately <ol style="list-style-type: none">1. Sapera LT: Provides everything you will need to build your imaging application2. Current Sapera compliant board hardware drivers3. Board and Sapera documentation (compiled HTML help, and Adobe Acrobat® (PDF) formats)	OC-SL00-0000000
<i>(optional)</i> Sapera Processing Imaging Development Library includes over 600 optimized image processing routines.	Contact Sales at Teledyne DALSA

X64 Xcelera-CL PX4 Cables & Accessories

Item	Product Number
<i>(optional)</i> X64 Xcelera-CL PX4 can be shipped with an External Signals Connector Bracket Assembly, either with a DB37 or DB25 connector (see the two product numbers below). Either cable, if required, should be specified at the time of order. Note: clients requiring more I/O connections must add the optional X-I/O Module. DB37 assembly see "External Signals Connector Bracket Assembly (Type 1)" on page 74. This cable assembly connects to J4. DB25 assembly see "External Signals Connector Bracket Assembly (Type 2)" on page 76. Provides direct compatibility with external cables made for products such as the X64-CL iPro. This cable assembly connects to J4.	OR-X4CC-IOCAB OR-X4CC-0TIO2

(optional) Power interface cable required when supplying power to cameras	OR-COMC-POW03
(optional) Camera Link Video Input Cable: 1 meter 2 meter	OC-COMC-CLNK0 OC-COMC-CLNK6
(optional) Power Over Camera Link (PoCL) Video Input Cable 2 meter HDR to MDR 1 meter MDR to MDR 2 meter MDR to MDR	OR-COMC-POCLD2 OR-COMC-POCLM1 OR-COMC-POCLM2
(optional) Cable bundle to connect Xcelera-CL PX4 to the X-I/O module (includes cable OC-I00C-ANLVDS)	OC-I00B-ALAM0

About the X64 Xcelera-CL PX4 Frame Grabber

Series Key Features

- Available either as a Full or Dual Base Camera Link board
- Acquire from Monochrome, Bayer Filter or RGB Cameras, both area scan and linescan
- Supports multiple tap formats and multiple tap scan directions, in multiple pixels depths
- On board hardware Flat Field Correction
- Output lookup tables
- Vertical and Horizontal Flip supported on board
- Supports a number of acquisition events in compliance with "Trigger to Image Reliability"
- RoHS compliant
- Supports Power Over Camera Link (PoCL)

See "Technical Specifications" on page 58 for detailed information.

User Programmable Configurations

Use the X64 Xcelera-CL PX4 firmware loader function in the Teledyne DALSA Device manager utility to select firmware for one of the supported modes. Firmware selection is made either during driver installation or manually later on (see "X64 Xcelera-CL PX4 Firmware Loader" on page 10).

For the X64 Xcelera-CL PX4 Full board the firmware choices are:

- **One Full Camera Link Input with Flat Field Correction** (*installation default selection*)
Support for 1 Base, 1 Medium or 1 Full Camera Link camera. Flat Field Correction (FFC) includes Fixed Pattern Noise (FPN), Pixel Replacement, Photo Response Non Uniformity (PRNU), and Shading Correction.
- **One Full Camera Link Input with Bayer Filter Decoding, Sapera Method 1:**
Support for 1 Base, 1 Medium or 1 Full Camera Link camera.
- **One Camera Link Input with 10 Taps @ 8 bits with Flat Field Correction:**
Supports camera such as the Basler A504.
- **One Full Camera Link Input with Bayer Filter Decoding, Sapera Method 6:**
Support for the Basler Sprint SPL8192 camera in enhanced mode.

For the X64 Xcelera-CL PX4 Dual board the firmware choices are:

- **Two independent Base Camera Link Input with Flat Field Correction** (*installation default selection*)
Support for 1 or 2 Base Camera Link cameras. Flat Field Correction (FFC) includes Fixed Pattern Noise (FPN), Pixel Replacement, Photo Response Non Uniformity (PRNU), and Shading Correction.
- **Two independent Base Camera Link Input with Bayer Filter Decoding, Sapera Method 1:**
Support for 1 or 2 Base Camera Link cameras with Hardware Bayer CFA (Color Filter Array) Decoder. Flat Field Correction is not available in this configuration.
- **One Medium Camera Link Input with Flat field correction:**
Support for 1 Base or 1 Medium Camera Link camera. Flat Field Correction (FFC) includes Fixed Pattern Noise (FPN), Pixel Replacement, Photo Response Non Uniformity (PRNU), and Shading Correction.
- **One Medium Camera Link Input with Bayer Filter Decoding, Sapera Method 1:**
Support for 1 Base or 1 Medium Camera Link camera with Hardware Bayer CFA (Color Filter Array) Decoder. Flat Field Correction is not available in this configuration.

ACUPlus: Acquisition Control Unit

ACUPlus consists of a grab controller, one pixel packer, and one time base generator. ACUPlus delivers a flexible acquisition front end plus it supports pixel clock rates of up to 85MHz.

ACUPlus acquires variable frame sizes up to 256KB per horizontal line and up to 16 million lines per frame. ACUPlus can also capture an infinite number of lines from a linescan camera without losing a single line of data.

ACUPlus supports standard Camera Link multi-tap configurations from 8 to 64-bit/pixels. Additionally, alternate tap configurations can support up to 8 taps of 8-bits each or optionally 10 tap with alternate firmware.

DTE: Intelligent Data Transfer Engine

The X64 Xcelera-CL PX4 intelligent Data Transfer Engine ensures fast image data transfers between the board and the host computer with zero CPU usage. The DTE provides a high degree of data integrity during continuous image acquisition in a non-real time operating system like Windows. DTE consists of multiple independent DMA units, Tap Descriptor Tables, and Auto-loading Scatter-Gather tables.

PCI Express x4 Interface

The X64 Xcelera-CL PX4 is a universal PCI Express x4 board, compliant with the PCI Express 1.1 specification. The X64 Xcelera-CL PX4 board achieves transfer rates up to 750 Mbytes/sec. with all taps used when connected to a corresponding camera or sensor.

The X64 Xcelera-CL PX4 board occupies one PCI Express x4 expansion slot and one chassis opening (two slots with the optional X-I/O Module Option).

Important:

- Older computers may not support the maximum data transfer bandwidth defined for PCI Express x4.
- The X64 Xcelera-CL PX4 board can also be used in an PCI Express x8 slot typically without issue.
- If the computer only has a PCI Express x16 slot, an x4 board must be tested to see if it is supported. It has been seen that many computer motherboards only support x16 products in x16 slots (commonly used with graphic video boards).

Advanced Controls Overview

Visual Indicators

X64 Xcelera-CL PX4 features LED indicators to facilitate system installation and setup. These indicators provide visual feedback on the board status and camera status.

External Event Synchronization

Trigger inputs and strobe signals are provided to precisely synchronize image captures with external events.

Camera Link Communications ports

One (Full board) or two (Dual board) PC independent communication ports provide Camera Link camera configurations. These ports do not require additional PC resources like free interrupts or I/O address space. Accessible via the board device driver, the communication ports present a seamless interface to Windows-based standard communication applications like HyperTerminal, etc. The communication ports are accessible directly from the Camera Link connectors.

Quadrature Shaft Encoder

An important feature for web scanning applications, the Quadrature-Shaft-Encoder inputs allow synchronized line captures from external web encoders.

About the Optional X-I/O Module

The optional X-I/O module adds independent general purpose software controllable I/O signals to the X64 Xcelera-CL PX4. The X-I/O module provides 2 opto-coupled inputs, 6 logic signal inputs (5V or 24V), and 8 TTL outputs (NPN or PNP type selectable). The module also makes available 5V or 12V dc power from the host system.

The X-I/O module can be either purchased with the X64 Xcelera-CL PX4 board or installed into the computer system at a later time. The module occupies one adjacent PCI slot and connects to the X64 Xcelera-CL PX4 via a ribbon cable. X-I/O Module external connections are made via the DB37 connector on the module bracket.

X-I/O requires X64 Xcelera-CL PX4 board driver version 1.00 or later and Sapera LT version 6.0 or later.

See "[Appendix: X-I/O Module Option](#)" on [page 80](#) for details and specifications.

Development Software Overview

Sapera++ LT Library

Sapera++ LT is a powerful development library for image acquisition and control. Sapera++ LT provides a single API across all current and future Teledyne DALSA hardware. Sapera++ LT delivers a comprehensive feature set including program portability, versatile camera controls, flexible display functionality and management, plus easy to use application development wizards. Applications are developed using either C++ or .NET frameworks.

Sapera++ LT comes bundled with CamExpert, an easy to use camera configuration utility to create new, or modify existing camera configuration files.

Sapera Processing Library

Sapera Processing is a comprehensive set of C++ classes or .NET classes for image processing and analysis. Sapera Processing offers highly optimized tools for image processing, blob analysis, search (pattern recognition), OCR and barcode decoding.

Installing X64 Xcelera-CL PX4

Warning! (Grounding Instructions)

Static electricity can damage electronic components. Please discharge any static electrical charge by touching a grounded surface, such as the metal computer chassis, before performing any hardware installation.

If you do not feel comfortable performing the installation, please consult a qualified computer technician.

Important: Never remove or install any hardware component with the computer power on. Disconnect the power cord from the computer to disable the power standby mode. This prevents the case where some computers unexpectedly power up when a board is installed.

Installation



Note: To install Sapera LT and the X64 Xcelera-CL PX4 device driver, logon to the workstation as administrator or with an account that has administrator privileges.

The Sapera LT Development Library (or 'runtime library' if application execution without development is preferred) must be installed before the Xcelera-CL PX4 device driver.

- Turn the computer off, disconnect the power cord (disables power standby mode), and open the computer chassis to allow access to the expansion slot area.
- Install the X64 Xcelera-CL PX4 into a free PCI Express x4 expansion slot. Note that some computer's x16 slot may support x4 board products.
- Connect a PC Floppy drive power connector to J7 for PoCL cameras or when DC power is required on the external signals connector J4.
- Close the computer chassis and turn the computer on.
- Windows will find the X64 Xcelera-CL PX4 and start its **Found New Hardware Wizard**. Click on the **Cancel** button to close the Wizard.
- If using **Windows Vista**, Windows will display its **Found New Hardware dialog**. Click on the default "Ask me again later" and continue with the installation. Note that if you select the third option "Don't show this message again for this device", there will be no prompt if the Teledyne DALSA board is installed in the same computer.

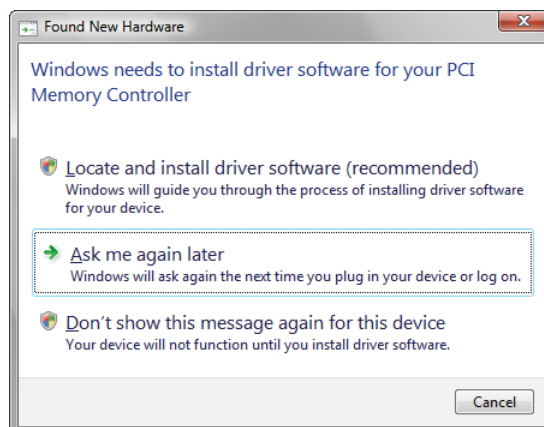

Figure 1: Found New Hardware

Sapera LT Library Installation

- Insert the Teledyne DALSA Sapera Essential CD-ROM. If **AUTORUN** is enabled on your computer, the installation menu is presented.
- If **AUTORUN** is not enabled, use Windows Explorer and browse to the root directory of the CD-ROM. Execute **launch.exe** to start the installation menu and install the required Sapera components.
- Continue with the installation of the board driver as described in the next section.
- The installation program will prompt you to reboot the computer.

Refer to *Sapera LT User's Manual* for additional details about Sapera LT.

X64 Xcelera-CL PX4 Driver Installation

The X64 Xcelera-CL PX4 board driver supports installation in a Windows XP, Windows Vista, Windows 7, or Windows 8 system.

- After installing Sapera, continue by selecting the X64 Xcelera-CL PX4 driver installation.
- Insert the Teledyne DALSA Sapera CD-ROM. If **AUTORUN** is enabled on your computer, the installation menu is presented. Install the X64 Xcelera-CL PX4 driver.
- If **AUTORUN** is not enabled, use Windows Explorer and browse to the root directory of the CD-ROM. Execute **launch.exe** to start the installation menu and install the X64 Xcelera-CL PX4 driver. During the late stages of the installation, the X64 Xcelera-CL PX4 firmware loader application starts. This is described in detail in the following section.
- If Windows displays any unexpected message concerning the installed board, power off the system and verify the X64 Xcelera-CL PX4 is installed in the slot properly.

X64 Xcelera-CL PX4 Firmware Loader

The Device Manager-Firmware Loader program automatically executes at the end of the driver installation and on every subsequent reboot of the computer. It will determine if the X64 Xcelera-CL PX4 requires a firmware update. If firmware is required, a dialog displays and it also allows the user to load firmware for alternate operational modes of the X64 Xcelera-CL PX4.

Important: In the very rare case of firmware loader errors please see "Recovering from a Firmware Update Error" on page 23.

Firmware Update: Automatic Mode

Click **Automatic** to update the X64 Xcelera-CL PX4 firmware. The **X64 Xcelera-CL PX4 Full** supports 4 firmware configurations with the default being a Full, Medium, or Base camera with Flat Field correction.

The **X64 Xcelera-CL PX4 Dual** board supports 4 firmware configurations with the default being dual Base cameras with Flat Field correction.

See "Series Key Features" on page 6 and "User Programmable Configurations" on page 6 for details on all supported modes, which can be selected via a manual firmware update.

If there are multiple X64 Xcelera-CL PX4 boards in the system, all will be updated with new firmware. If any installed X64 Xcelera-CL PX4 board installed in a system already has the correct firmware version, an update is not required. In the following screen shot, a single X64 Xcelera-CL PX4 Full board is installed in the system and the default configuration is ready to be programmed.

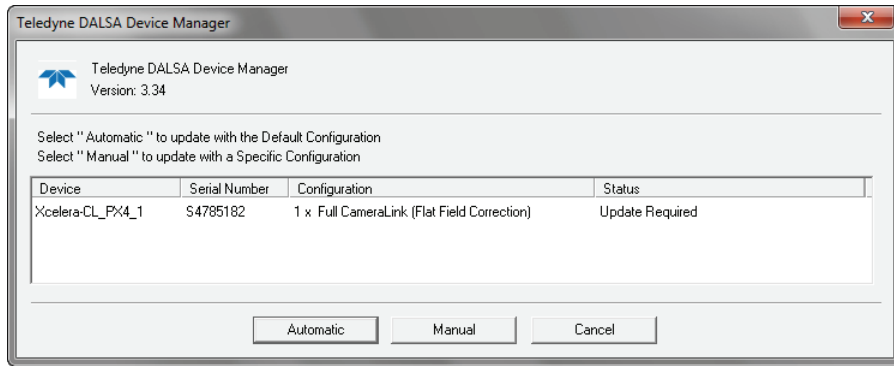

Firmware Update: Manual Mode

Select **Manual** mode to load firmware other than the default version or when, in the case of multiple X64 Xcelera-CL PX4 boards in the same system, each requires different firmware.

The figure below shows the Device Manager manual firmware screen. Information on all installed X64 Xcelera-CL PX4 boards, their serial numbers, and their firmware components are shown.

A manual firmware update is made as follows:

- Select the X64 Xcelera-CL PX4 to update via the board selection box (if there are multiple boards in the system)
- From the Configuration field drop menu select the firmware version required
- Click on the Start Update button
- Observe the firmware update progress in the message output window
- Close the Device manager program when the device reset complete message is shown.

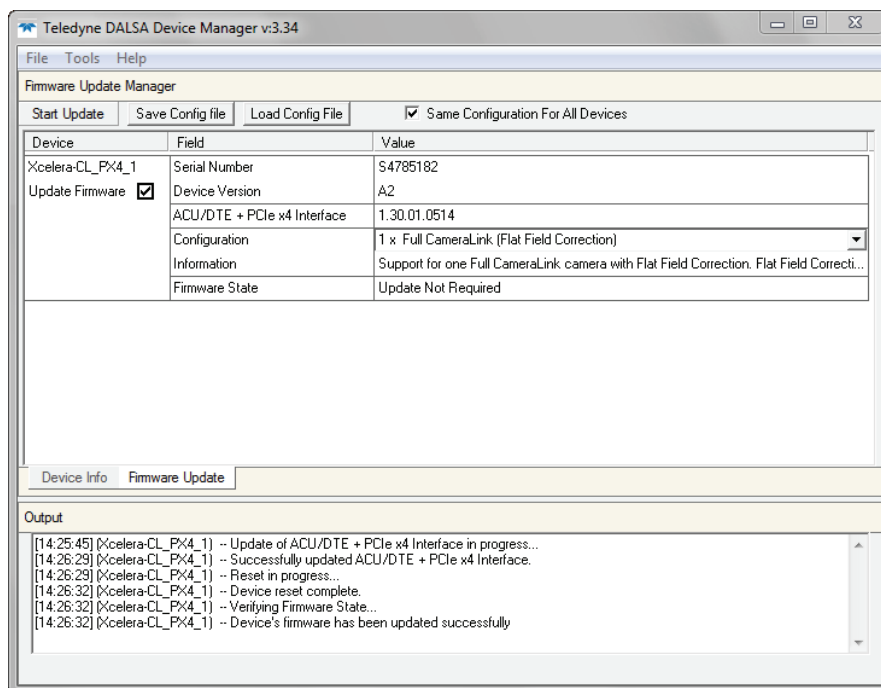

Executing the Firmware Loader from the Start Menu

If required, the X64-Xcelera-CL PX4 Firmware Loader program is executed via the Windows Start Menu shortcut **Start • Programs • Teledyne DALSA • X64 Xcelera-CL PX4 Driver • Firmware Update**. A firmware change after installation would be required to select a different configuration mode. See "User Programmable Configurations" on page 6.

Requirements for a Silent Install

Both Sapera LT and the X64 Xcelera-CL PX4 driver installations share the same installer technology. When the installations of Teledyne DALSA products are embedded within a third party's product installation, the mode can either have user interaction or be completely silent. The following installation mode descriptions apply to both Sapera and the hardware driver.



Note: You must reboot after the installation of Sapera LT. However, to streamline the installation process, Sapera LT can be installed without rebooting before installing the board hardware device drivers. The installations then complete with a single final system reboot.

Perform Teledyne DALSA embedded installations in either of these two ways:

- **Normal Mode**

The default mode is interactive. This is identical to running the setup.exe program manually from Windows (either run from Windows Explorer or the Windows command line).

- **Silent Mode**

This mode requires no user interaction. A preconfigured "response" file provides the user input. The installer displays nothing.

Silent Mode Installation

A Silent Mode installation is recommended when integrating Teledyne DALSA products into your software installation. The silent installation mode allows the device driver installation to proceed without the need for mouse clicks or other input from a user.

Preparing a Silent Mode Installation requires two steps:

- Prepare the response file, which emulates a user.
- Invoke the device driver installer with command options to use the prepared response file.

Creating a Response File

Create the installer response file by performing a device driver installation with a command line switch "-r". The response file is automatically named `setup.iss` and is saved in the `\windows` folder. If a specific directory is desired, the switch `-f1` is used.

As an example, to save a response file in the same directory as the installation executable of the X64 Xcelera-CL PX4, the command line would be:

```
X64_Xcelera-CL_PX4_1.40.exe -r -f1".\setup.iss"
```

Running a Silent Mode Installation

A device driver silent installation, whether done alone or within a larger software installation requires the device driver executable and the generated response file `setup.iss`.

Execute the device driver installer with the following command line:

```
X64_Xcelera-CL_PX4_1.40.exe -s -f1".\setup.iss"
```

Where the `-s` switch specifies the silent mode and the `-f1` switch specifies the location of the response file. In this example, the switch `-f1".\setup.iss"` specifies that the `setup.iss` file be in the same folder as the device driver installer.



Note: On Windows Vista, Windows 7 or Windows 8, the Windows Security dialog box will appear unless one has already notified Windows to 'Always trust software from "Teledyne DALSA Inc."' during a previous installation of a driver.

Silent Mode Uninstall

Similar to a silent installation, a response file must be prepared first as follows.

Creating a Response File

The installer response file is created by performing a device driver un-installation with a command line switch "-r". The response file is automatically named `setup_uninstall.iss` which is saved in the \windows folder. If a specific directory is desired, the switch "-f1" is used.

As an example, to save a response file in the same directory as the installation executable of the X64 Xcelera-CL PX4, the command line would be:

```
X64_Xcelera-CL_PX4_1.40.exe -r -f1".\setup_uninstall.iss"
```

Running a Silent Mode Uninstall

Similar to the device driver silent mode installation, the un-installation requires the device driver executable and the generated response file `setup.iss`.

Execute the device driver installer with the following command line:

```
X64_Xcelera-CL_PX4_1.40.exe -s -f1".\setup_uninstall.iss"
```

Where the `-s` switch specifies the silent mode and the `-f1` switch specifies the location of the response file. In this example, the switch `-f1".\setup_uninstall.iss"` specifies that the `setup_uninstall.iss` file be in the same folder as the device driver installer.

Silent Mode Installation Return Code

A silent mode installation creates a file "corinstall.ini" in the Windows directory. A section called [SetupResult] contains the 'status' of the installation. A value of 1 indicates that the installation has started and a value of 2 indicates that the installation has terminated.

A silent mode installation also creates a log file "setup.log" which by default is created in the same directory and with the same name (except for the extension) as the response file. The /f2 option enables you to specify an alternative log file location and file name, as in `Setup.exe /s /f2"C:\Setup.log"`.

The "setup.log" file contains three sections. The first section, [InstallShield Silent], identifies the version of InstallShield used in the silent installation. It also identifies the file as a log file. The second section, [Application], identifies the installed application name, version, and the company name. The third section, [ResponseResult], contains the 'ResultCode' indicating whether the silent installation succeeded. A value of 0 means the installation was successful.

Installation Setup with CorAppLauncher.exe

The installation setup can be run with the CorAppLauncher.exe tool provided with the driver.

- Install the board driver and get CorAppLauncher.exe from the \bin directory of the installation.
- When running the installation, CorAppLauncher.exe will return only when the installation is finished.
- When run from within a batch file, obtain the installation exit code from the ERRORLEVEL value.
- The arguments to CorAppLauncher.exe are
 - l: Launch application
 - f: Application to launch. Specify a fully qualified path.

As an example:

- `CorAppLauncher -l -f"c:\driver_install\x64_xcelera-cl_PX4_1.40.exe"`
- `IF %ERRORLEVEL% NEQ 0 goto launch error`



Note: There is a 32-bit and 64-bit version of CorAppLauncher.exe. When installing the driver, only the version related to the OS is installed. However, the 32-bit version is usable on either 32-bit or 64-bit Windows.

Custom Driver Installation using install.ini

Customize the driver installation by parameters defined in the file "install.ini". By using this file, the user can:

- Select the user default configuration.
- Select different configurations for systems with multiple boards.
- Assign a standard Serial COM port to board.

Creating the install.ini File

- Install the driver in the target computer. All X64 Xcelera-CL PX4 boards required in the system must be installed.
- Configure each board's acquisition firmware using the Teledyne DALSA Device Manager tool (see "Device Manager – Board Viewer" on page 17).
- If a standard Serial COM port is required for any board, use the Sopera Configuration tool (see "COM Port Assignment" on page 16).
- When each board setup is complete, using the Teledyne DALSA Device Manager tool, click on the Save Config File button. This will create the "install.ini" file.

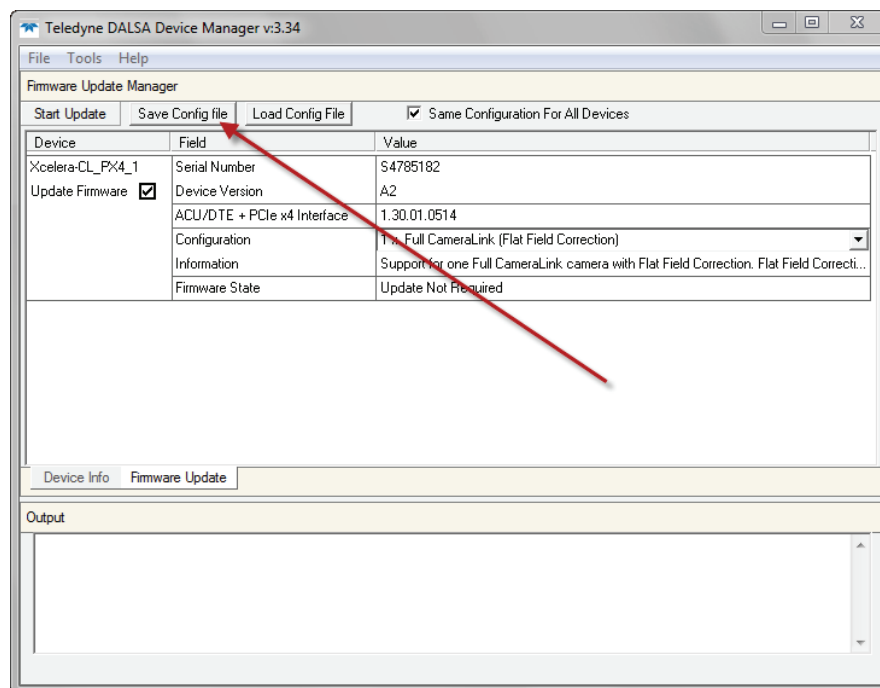

Figure 2: Create an install.ini File

Run the Installation using install.ini

Copy the install.ini file into the same directory as the setup installation file. Run the setup installation as normal. The installation will automatically check for an install.ini file and if found, use the configuration defined in it.

Upgrading Sopera or any Board Driver

When installing a new version of Sopera or a Teledyne DALSA acquisition board driver in a computer with a previous installation, the current version **must** be un-installed first. Described below are two upgrade situations. Note that if the board is installed in a different slot, the new hardware wizard opens. Answer as instructed in section "Installation" on page 9.

Board Driver Upgrade Only

Minor upgrades to acquisition board drivers are typically distributed as ZIP files available in the Teledyne DALSA web site <http://www.teledynedalsa.com/imaging/support/>. Board driver revisions are also available on the next release of the Sopera CD-ROM.

Often minor board driver upgrades do not require a new revision of Sopera. To confirm that the current Sopera version will work with the new board driver:

- Check the new board driver ReadMe file before installing, for information on the minimum Sopera version required.
- If the ReadMe file does not specify the Sopera version, contact Teledyne DALSA Technical Support (see "Technical Support" on page 91).

To upgrade the board driver only:

- Logon the computer as an administrator or with an account that has administrator privileges.
- In **Windows XP**, from the start menu select **Start • Settings • Control Panel • Add or Remove Programs**. Select the Teledyne DALSA Xcelera board driver and click **Remove**.
- **Windows XP only:**
 - When the driver un-install is complete, reboot the computer.
 - Logon the computer as an administrator again.
- In **Windows Vista, Windows 7**, from the start menu select **Start • Settings • Control Panel • Programs and Features**. Double-click the Teledyne DALSA Xcelera board driver and click **Remove**.
- Install the new board driver. Run **Setup.exe** if installing manually from a downloaded driver file.
- If the new driver is on a Sopera CD-ROM follow the installation procedure described in "X64 Xcelera-CL PX4 Driver" on page 10.
- Note that you can not install a Teledyne DALSA board driver without Sopera LT installed on the computer.

Sopera and Board Driver Upgrades

When upgrading both Sopera and the acquisition board driver, follow the procedure described below.

- Logon the computer as an administrator or with an account that has administrator privileges.
- In Windows XP, from the start menu select **Start • Settings • Control Panel • Add or Remove Programs**. Select the Teledyne DALSA Xcelera board driver and click **Remove**. Follow by also removing the older version of Sopera LT.
- In Windows Vista/7, from the start menu select **Start • Settings • Control Panel • Programs and Features**. Double-click the Teledyne DALSA Xcelera board driver and click **Remove**. Follow by also removing the older version of Sopera LT.
- Reboot the computer and logon the computer as an administrator again.
- Install the new versions of Sopera and the board driver as if this was a first time installation. See "Sopera LT Library Installation" on page 10 and "X64 Xcelera-CL PX4 Driver" on page 10 for installation procedures.

Using the Camera Link Serial Control Port

The Camera Link cabling specification includes a serial communication port for direct camera control by the frame grabber (see "J2: Camera Link Connector 1 " on page 66). The X64 Xcelera-CL PX4 driver supports this serial communication port either directly or by mapping it to a host computer COM port. Any serial port communication program, such as Windows HyperTerminal, can connect to the camera in use and modify its function modes via its serial port controls. The X64 Xcelera-CL PX4 serial port supports communication speeds from 9600 to 921600 bps.



Note: If your serial communication program can directly select the X64 Xcelera-CL PX4 serial port then mapping to a system COM port is not necessary.

The X64 Xcelera-CL PX4 serial port is mapped to an available COM port by using the Sopera Configuration tool. Run the program from the Windows start menu: **Start • Programs • Teledyne DALSA • Sopera LT • Sopera Configuration.**

COM Port Assignment

The lower section of the Sopera Configuration program screen contains the serial port configuration menu. Configure as follows:

- Use the **Physical Port** drop menu to select the Sopera board device from all available Sopera boards with serial ports (when more than one board is in the system).
- Use the **Maps to** drop menu to assign an available COM number to that Sopera board serial port.
- Click on the **Save Settings Now** button then the **Close** button. You are prompted to reboot your computer to enable the serial port mapping.
- The X64 Xcelera-CL PX4 serial port, now mapped to COM3 in this example, is available as a serial port to any serial port application for camera control. Note that this serial port is not listed in the **Windows Control Panel • System Properties • Device Manager** because it is a logical serial port mapping.
- An example setup using Windows HyperTerminal follows.

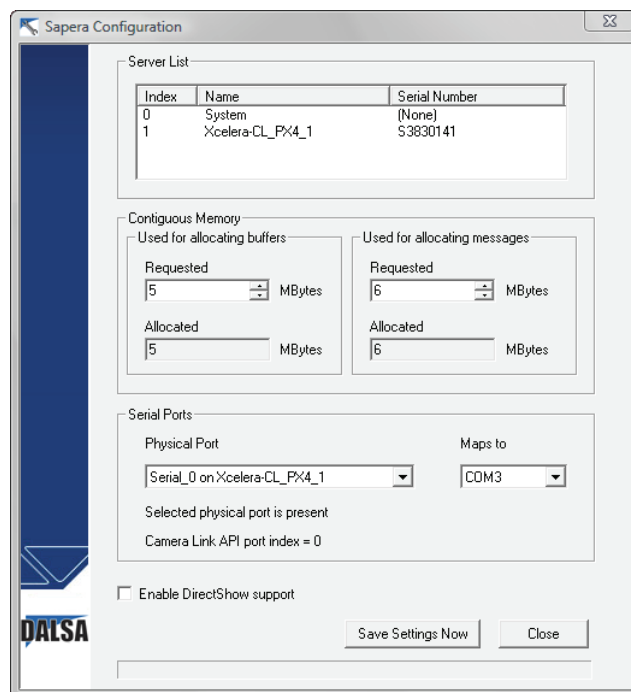

Setup Example with Windows XP HyperTerminal

- Run HyperTerminal and type a name for the new connection when prompted. Then click OK.
- On the following dialog screen select the port to connect with. The port could be the COM port mapped to the X64 Xcelera-CL PX4 or the COM device as shown in this example.

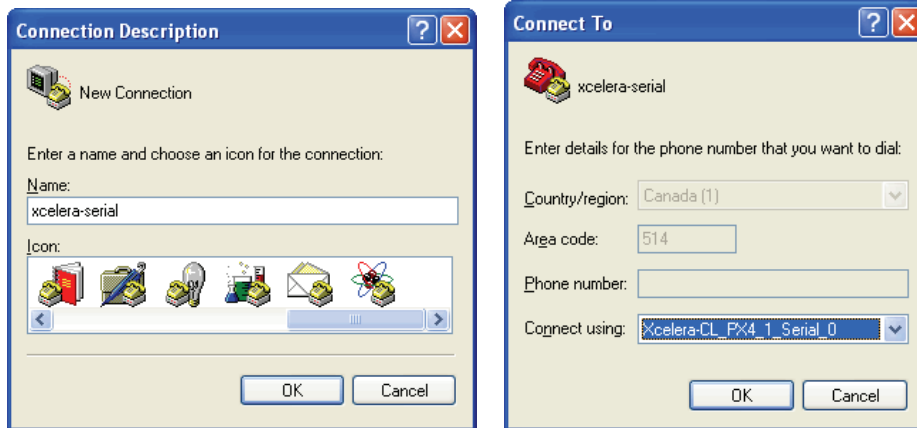

- HyperTerminal now presents a dialog to configure the COM port properties. Change settings as required by the camera you are connecting to. Note that the X64 Xcelera-CL PX4 serial port does not support hardware flow control.

Displaying X64 Xcelera-CL PX4 Board Information

The Device Manager program also displays information about the X64 Xcelera-CL PX4 boards installed in the system. To view board information run the program via the Windows Start Menu shortcut **Start • Programs • Teledyne DALSA • X64 Xcelera-CL PX4 Device Driver • Device Manager**.

Device Manager – Board Viewer

The following screen image shows the Device Manager program with the Information/Firmware tab active. The left window displays all X64 Xcelera-CL PX4 boards in the system and their individual device components. The right window displays the information stored in the selected board device. This example screen shows the X64 Xcelera-CL PX4 information contained in the EEPROM component.

The X64 Xcelera-CL PX4 device manager report file (BoardInfo.txt) is generated by clicking **File • Save Device Info**. This report file may be requested by Teledyne DALSA Technical Support to aid in troubleshooting installation or operational problems.

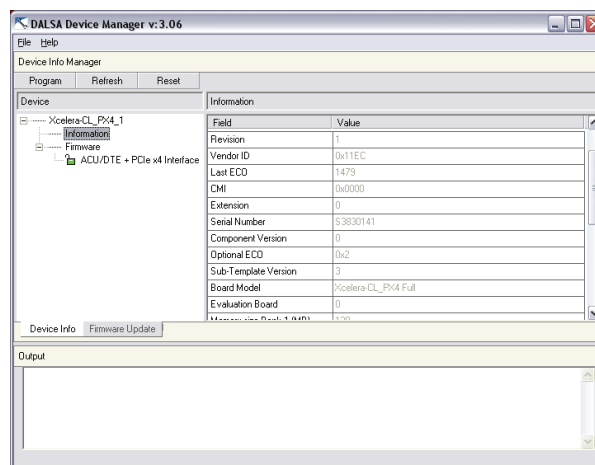

Configuring Sopera

Viewing Installed Sopera Servers

The Sopera configuration program (**Start • All Programs • Teledyne DALSA • Sopera LT • Sopera Configuration**) allows the user to see all available Sopera servers for the installed Sopera-compatible boards. The **System** entry represents the system server. It corresponds to the host machine (your computer) and is the only server that should always be present.

Increasing Contiguous Memory for Sopera Resources

The **Contiguous Memory** section lets the user specify the total amount of contiguous memory (a block of physical memory, occupying consecutive addresses) reserved for the resources needed for **Sopera buffers** allocation and **Sopera messaging**. For both items, the **Requested** value dialog box shows the driver default memory setting while the **Allocated** value displays the amount of contiguous memory that has been allocated successfully. The default values will generally satisfy the needs of most applications.

The **Sopera buffers** value determines the total amount of contiguous memory reserved at boot time for the allocation of dynamic resources used for host frame buffer management such as DMA descriptor tables plus other kernel needs. Adjust this value higher if your application generates any out-of-memory error while allocating host frame buffers or when connecting the buffers via a transfer object. You can approximate the amount of contiguous memory required as follows:

- Calculate the total amount of host memory used for frame buffers
[number of frame buffers • number of pixels per line • number of lines • (2 - if buffer is 10 or 12 bits)].
- Provide 1MB for every 256 MB of host frame buffer memory required.
- Add an additional 1 MB if the frame buffers have a short line length, say 1k or less (the increased number of individual frame buffers requires more resources).
- Add an additional 2 MB for various static and dynamic Sopera resources.
- Add the amount of memory needed for DMA tables using the formula (Sopera 7.10 and up):
[number of frame buffers • number of lines • 16 • (line length in bytes / 4kB)].
- Test for any memory error when allocating host buffers. Simply use the Buffer menu of the Sopera Grab demo program (see "Grab Demo Overview" on page 35) to allocate the number of host buffers required for your acquisition source. Feel free to test the maximum limit of host buffers possible on your host system – the Sopera Grab demo will not crash when the requested number of host frame buffers cannot be allocated.

Host Computer Frame Buffer Memory Limitations

When planning a Sopera application and its host frame buffers used, plus other Sopera memory resources, do not forget the Windows operating system memory needs.

A Sopera application using the preferred *scatter gather buffers* could consume most of the remaining system memory, with a large allocation of frame buffers. If using frame buffers allocated as a *single contiguous memory block*, Windows will limit the allocation dependent on the installed system memory. Use the Buffer menu of the Sopera Grab demo program to allocate host buffer memory until an error message signals the limit allowed by the operating system used.

Contiguous Memory for Sopera Messaging

The current value for **Sopera messaging** determines the total amount of contiguous memory reserved at boot time for messages allocation. This memory space is used to store arguments when a Sopera function is called. Increase this value if you are using functions with large arguments, such as arrays and experience any memory errors.

Troubleshooting Problems

Overview

The X64 Xcelera-CL PX4 (and the X64 family of products) is tested by Teledyne DALSA in a variety of computers. Although unlikely, installation problems may occur due to the constant changing nature of computer equipment and operating systems. This section describes what the user can verify to determine the problem or the checks to make before contacting Technical Support.

If you require help and need to contact Technical Support, make detailed notes on your installation and/or test results for our technical support to review. See ["Technical Support" on page 91](#) for contact information.

Problem Type Summary

X64 Xcelera-CL PX4 problems are either installation types where the board hardware is not recognized on the PCIe bus (i.e. trained) or function errors due to camera connections or bandwidth issues. The following links jump to various topics in this troubleshooting section.

First Step: Check the Status LED

A RED Status LED 1 indicates a camera problem, while various Green states indicate the acquisition mode.

Status LED 2, if flashing RED, indicates a PCIe bus problem. If you run the PCI Diagnostics tool, the LX1 is not in the PCI device list. If the board is installed in a computer which supports PCIe GEN2 expansion slots, see section ["SW3-2 GEN2 Slot Workaround Details" on page 64](#).

The complete status LED description is available in the technical reference section (see ["Status LEDs Functional Description" on page 65](#)).

Possible Installation Problems

- **Hardware PCI bus conflict:** When a new installation produces PCI bus error messages or the board driver doesn't install, it is important to verify that there are no conflicts with other PCI or system devices already installed. Use the Teledyne DALSA PCI Diagnostic tool as described in ["Checking for PCI Bus Conflicts" on page 21](#). Also verify the installation via the ["Driver Information via the Device Manager Program" on page 24](#).
- **Gen2 slot errors:** There is a PCI bus error message from the computer bios. Follow the instructions ["GEN2 PCI Slot Computer Issue" on page 23](#).
- **BSOD (blue screen) following a board reset:** After programming the board with different firmware, the computer displays the BSOD when the board is reset (see ["BSOD \(blue screen\) Following a Board Reset" on page 23](#)).
- **Verify Sapera and Board drivers:** If there are errors when running applications, confirm that all Sapera and board drivers are running. See ["Sapera and Hardware Windows Drivers" on page 23](#) for details. In addition, Teledyne DALSA technical support will ask for the log file of messages by board drivers. Follow the instructions describe in ["Teledyne DALSA Log Viewer" on page 25](#).
- **Firmware update error:** There was an error during the board firmware update procedure. This usually is easily corrected by the user. Follow the instructions ["Recovering from a Firmware Update Error" on page 23](#).
- Installation went well but the board doesn't work or stopped working. Review these steps described in ["Symptoms: CamExpert Detects no Boards" on page 25](#).

Possible Functional Problems

- **Driver Information:** Use the Teledyne DALSA Device Manager program to view information about the installed X64 Xcelera-CL PX4 board and driver. See "Driver Information via the Device Manager Program" on page 24.
- **On-Board Image Memory Requirements:** The X64 Xcelera-CL PX4 on-board memory provides two frame buffers large enough for most imaging situations. See "On-board Image Memory Requirements for Acquisitions" on page 25 for details on the on board memory and possible limitations.

Sometimes the problem symptoms are not the result of an installation issue but due to other system issues. Review the sections described below for solutions to various X64 Xcelera-CL PX4 functional problems.

- "Symptoms: X64 Xcelera-CL PX4 Does Not Grab" on page 26
- "Symptoms: Card grabs black" on page 26
- "Symptoms: Card acquisition bandwidth is less than expected" on page 26

Troubleshooting Procedures

The following sections provide information and solutions to possible X64 Xcelera-CL PX4 installation and functional problems. These topics are summarized in the previous section of this manual.

Checking for PCI Bus Conflicts

One of the first items to check when there is a problem with any PCI board is to examine the system PCI configuration and ensure that there are no conflicts with other PCI or system devices. The Teledyne DALSA *PCI Diagnostic* program (**cpctdiag.exe**) allows examination of the PCI configuration registers and can save this information to a text file. Run the program via the Windows Start Menu shortcut **Start • All Programs • Teledyne DALSA • Spera LT • Tools • PCI Diagnostics**.

As shown in the following screen image, use the first drop menu to select the PCI device to examine. Select the device from Teledyne DALSA. Note the bus and slot number of the installed board (this will be unique for each system unless systems are setup identically). Click on the **Diagnostic** button to view an analysis of the system PCI configuration space.

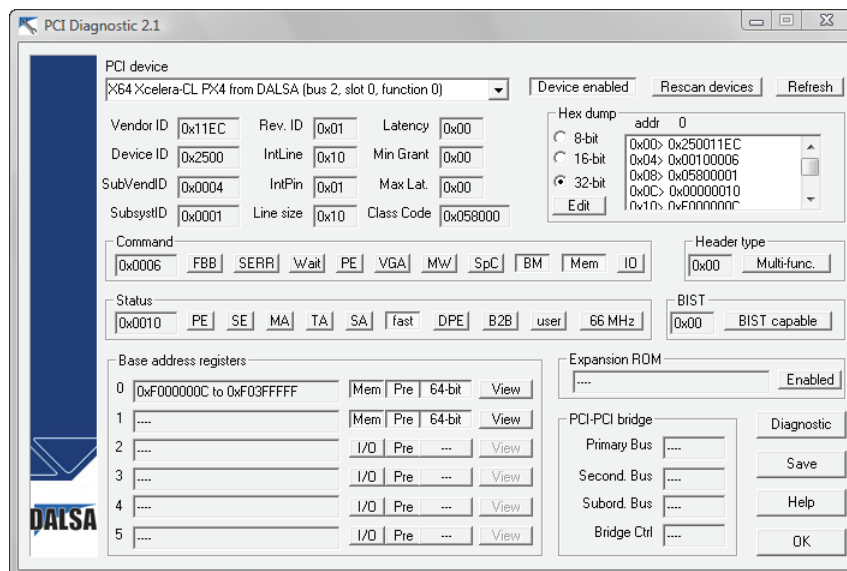

Clicking on the **Diagnostic** button opens a new window with the diagnostic report. From the PCI Bus Number drop menu select the bus number that the X64 Xcelera-CL PX4 is installed in—in this example the slot is bus 2.

The window now shows the I/O and memory ranges used by each device on the selected PCI bus. The information display box will detail any PCI conflicts. If there is a problem, click on the **Save** button. A file named **'pcidiag.txt'** is created (in the Sapera\bin directory) with a dump of the PCI configuration registers. Email this file when requested by the Teledyne DALSA Technical Support group along with a full description of your computer.

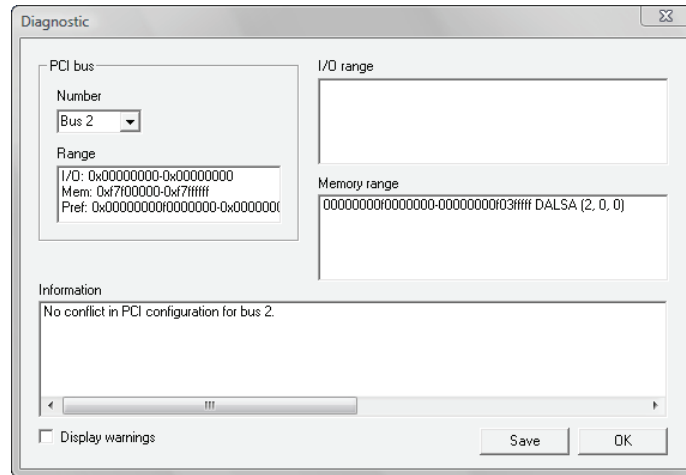

Windows Device Manager

In Windows use the Start Menu shortcut **Start • Settings • Control Panel • System • Hardware • Device Manager**. As shown in the following screen images, look for *X64 Xcelera-CL PX4* board under "Imaging Devices". Double-click and look at the device status. You should see "This device is working properly." Go to "Resources" tab and make certain that the device is mapped and has an interrupt assigned to it, without any conflicts.

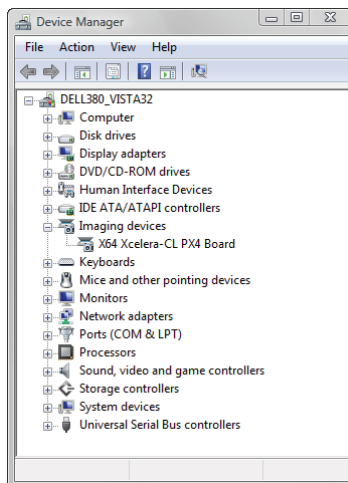

GEN2 PCI Slot Computer Issue

At boot time, the PX4 status LED 2 keeps on flashing red. If you run the PCI Diagnostics tool, the PX4 is not in the PCI device list. If the board is installed in a computer which supports PCIe GEN2 expansion slots, see section "SW3-2 GEN2 Slot Workaround Details" on page 64.

BSOD (blue screen) Following a Board Reset

Teledyne DALSA engineering has identified cases where a PC will falsely report a hardware malfunction when the X64 Xcelera-CL PX4 board is reset. The symptoms will be a Windows blue screen or PC that freezes following a board reset. The solution to this problem is to install the driver using the switch "/cr", indicating to the driver that a reset of the board must not be allowed and that a reboot of the computer is needed instead.

- **Example:** X64_Xcelera-CL_PX4_1.00.00.0000.exe /cr

Sapera and Hardware Windows Drivers

The next step is to make certain the appropriate Teledyne DALSA drivers have started successfully during the boot sequence. Example, click on the **Start • Programs • Accessories • System Tools • System Information • Software Environment**. Click on **System Drivers**. Make certain the following drivers have started for the **X64 Xcelera-CL PX4**.

Device	Description	Type	Started
CorX64Expre4x	X64 Xcelera-CL PX4 messaging	Kernel Driver	Yes
CorLog	Sapera Log viewer	Kernel Driver	Yes
CorMem	Sapera Memory manager	Kernel Driver	Yes
CorPci	Sapera PCI configuration	Kernel Driver	Yes
CorSerial	Sapera Serial Port manager	Kernel Driver	Yes

Teledyne DALSA Technical Support may request that you check the status of these drivers as part of the troubleshooting process.

Recovering from a Firmware Update Error

This procedure is required if any failure occurred while updating the X64 Xcelera-CL PX4 firmware on installation or during a manual firmware upgrade. On the rare occasion the board has corrupted firmware, any Sapera application such as CamExpert or the grab demo program will not find an installed board to control.

Possible reasons for firmware loading errors or corruption are:

- Computer system mains power failure or deep brown-out.
- PCI bus or checksum errors.
- PCI bus timeout conditions due to other devices.
- User forcing a partial firmware upload using an invalid firmware source file.

When the X64 Xcelera-CL PX4 firmware is corrupted, executing a manual firmware upload will not work because the firmware loader can not communicate with the board. In an extreme case, corrupted firmware may even prevent Windows from booting.

Solution: The user manually forces the board to initialize from write protected firmware designed only to allow driver firmware uploads. When the firmware upload is complete, the board is then rebooted to initialize in its normal operational mode.

- Note that this procedure may require removing the X64 Xcelera-CL PX4 board several times from the computer.

- **Important:** Referring to the board's user manual (in the connectors and jumpers reference section), identify the configuration switch location. The Boot Recovery Mode switch for the X64 Xcelera-CL PX4 is SW3-1 (see "SW3: " on page 64).
- Shut down Windows and power OFF the computer.
- Move the switch SW3-1 to ON, for the boot recovery mode position. (The default position is SW3-1 to OFF for normal operation).
- Power on the computer. Windows will boot normally.
- When Windows has started, do a manual firmware update procedure to update the firmware again (see "Firmware Update: Manual Mode" on page 11).
- When the update is complete, shut down Windows and power off the computer.
- Set the SW3-1 switch back to the OFF position (i.e. default position) and power on the computer once again.
- Verify that the frame grabber is functioning by running a Sopera application such as CamExpert. The Sopera application will now be able to communicate with the X64 Xcelera-CL PX4 board.

Driver Information via the Device Manager Program

The Teledyne DALSA Device Manager program provides a convenient method of collecting information about the installed X64 Xcelera-CL PX4. System information such as operating system, computer CPU, system memory, PCI configuration space, plus X64 Xcelera-CL PX4 firmware information can be displayed or written to a text file (default file name – BoardInfo.txt). Note that this is a second function mode of the same program used to manually upload firmware to the X64 Xcelera-CL PX4.

Execute the program via the Windows Start Menu shortcut **Start • All Programs • Teledyne DALSA • X64 Xcelera-CL PX4 Device Driver • Device Manager**. If the Device Manager program does not run, it will exit with a message that the board was not found. Since the X64 Xcelera-CL PX4 board must have been in the system to install the board driver, possible reasons for an error are:

- Board was removed
- Board driver did not start or was terminated
- PCI conflict after some other device was installed

Information Window

The following figure shows the Device Manager information screen. Click to highlight one of the board components and the information for that item is shown on the right hand window, as described below.

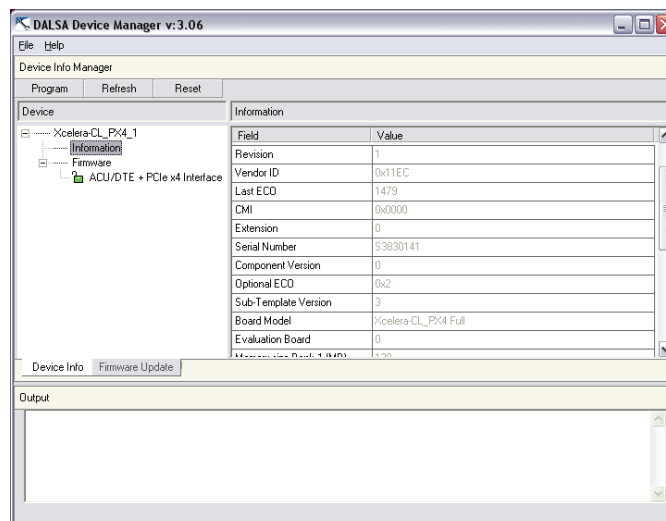

- Select **Information** to display identification and information stored in the X64 Xcelera-CL PX4 firmware.
- Select **Firmware** to display version information for the firmware components.
- Select one of the firmware components to load *custom* firmware when supplied by Teledyne DALSA engineering for a future feature.
- Click on **File • Save Device Info** to save all information to a text file. Email this file when requested by Technical Support.

Teledyne DALSA Log Viewer

A step in the verification process is to save in a text file the information collected by the Log Viewer program. Run the program via the Windows Start Menu shortcut **Start • All Programs • Teledyne DALSA • Spera LT • Tools • Log Viewer**.

The Log Viewer lists information about the installed board drivers. Click on File • Save and you will be prompted for a text file name to save the Log Viewer contents. Email this text file to Teledyne DALSA Technical Support when requested or as part of your initial contact email.

On-board Image Memory Requirements for Acquisitions

The X64 Xcelera-CL PX4 allocates by default two frame buffers in on-board memory, each equal in size to the acquisition frame buffer. This double buffering memory allocation is automatic at the driver level. Two buffers will ensure that the acquired video frame is complete and not corrupted in cases where the image transfer to host system memory may be interrupted and delayed by other host system processes. That is, the image acquisition to one frame buffer is not interrupted by any delays in transfer of the other frame buffer (which contains the previously acquired video frame) to system memory. Note that an application can change the number of on-board frame buffers using the Spera LT API. If allocation for the requested number of buffers fails, the driver will reduce the number of on-board frame buffers requested until they can all fit. When reaching 2 on-board buffers, if they still cannot fit, the driver will reduce the size such that it allocates two partial buffers. This mode will write image data to the buffer while wrapping image lines around to the beginning of a buffer when full. This mode relies on reading out the image data to the host computer faster than the acquisition.

Symptoms: CamExpert Detects no Boards

- **If using Spera version 6.00 or later:**
When starting CamExpert, if no Teledyne DALSA board is detected, CamExpert will start in offline mode. There is no error message and CamExpert is functional for creating or modifying a camera configuration file. If CamExpert should have detected the installed board, troubleshoot the installation problem as described below.

Troubleshooting Procedure

When CamExpert detects no installed board, there could be a hardware problem, a PnP problem, a PCI problem, a kernel driver problem, or a software installation problem.

- Make certain that the card is properly seated in PCIe slot.
- Perform all installation checks described in this section before contacting Technical Support.
- Try the board in a different PCIe slot if available.

Symptoms: X64 Xcelera-CL PX4 Does Not Grab

You are able to start Sopera CamExpert but you do not see an image and the frame rate displayed is 0.

- Verify power is connected to the camera.
- Verify the camera and timing parameters with the camera in free run mode.
- Verify you can grab with the camera in free run mode.
- Make certain that you provide an external trigger if the camera configuration file requires one. Use the software trigger feature of CamExpert if you do not have a trigger source.
- Make certain that the camera is properly connected to the cable.
- Make certain that the camera is configured for the proper mode of operation. This must match the camera configuration file. Refer to your camera datasheet.
- Try to snap one frame instead of continuous grab.
- Perform all installation checks described in this section before contacting Technical Support.

Symptoms: Card grabs black

You are able to use Sopera CamExpert, the displayed frame rate is as expected, but the display is always black.

- Set your camera to manual exposure mode and set the exposure to a longer period, plus open the lens iris.
- Try to snap one frame instead of continuous grab.
- Make certain that the input LUT is not programmed to output all '0's.
- This problem is sometimes caused by a PCIe transfer issue. No PCIe transfer takes place, so the frame rate is above 0 but nevertheless no image is displayed in CamExpert.
- Make certain that BUS MASTER bit in the PCIe configuration space is activated. Look in PCI Diagnostics for **BM** button under "Command" group. Make certain that the **BM** button is activated.
- Perform all installation checks described in this section before contacting Technical Support.

Symptoms: Card acquisition bandwidth is less than expected

The X64 Xcelera-CL PX4 acquisition bandwidth is less than expected.

- Review the system for problems or conflicts with other expansion boards or drivers.
- Remove other PCI Express, PCI-32 or PCI-64 boards and check acquisition bandwidth again. engineering has seen this case where other PCI boards in some systems cause limitations in transfers. Each system, with its combination of system motherboard and PCI boards, will be unique and will need to be tested for bandwidth limitations affecting the imaging application.
- Is the X64 Xcelera-CL PX4 installed in a PCI Express x16 slot?
Note that some computer's x16 slot may only support non x16 boards at x1 or not at all. Check the computer documentation or test an X64 Xcelera-CL PX4 installation. Note that the X64 Xcelera-CL PX4 board is not designed to function at x1 speeds. The speed at which the board is running at is logged in the LogViewer. Check for an entry similar to this:
"...X64_FPGA_GetPciSpeed = x8..."

CamExpert Quick Start

Interfacing Cameras with CamExpert

CamExpert is the camera interfacing tool for frame grabber boards supported by the Sopera library. CamExpert generates the Sopera camera configuration file (*yourcamera.ccf*) based on timing and control parameters entered. For backward compatibility with previous versions of Sopera, CamExpert also reads and writes the *.cca and *.cvi camera parameter files.

Every Sopera demo program starts by a dialog window to select a camera configuration file. Even when using the X64 Xcelera-CL PX4 with common video signals, a camera file is required. Therefore CamExpert is typically the first Sopera application run after an installation. Obviously existing .ccf files can be copied to the new installation when similar cameras are used.

CamExpert Example with a Monochrome Camera

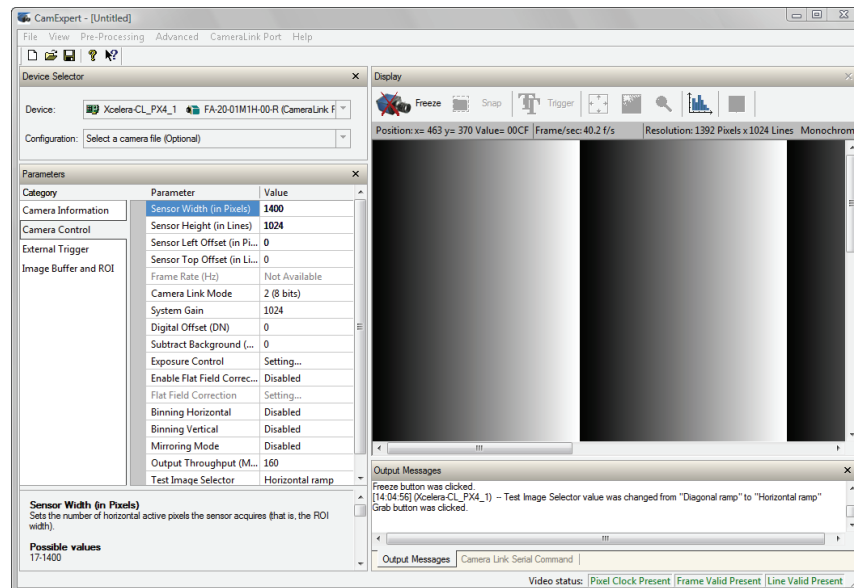

The image below shows CamExpert with the X64 Xcelera-CL PX4. The camera outputs monochrome 8-bit video on a Camera Link interface. After selecting the camera model, the timing parameters are displayed and the user can test by clicking on *Grab*. Descriptions of the CamExpert windows follows the image.



CamExpert groups parameters into functional categories. The parameters shown depend on the frame grabber used and what camera is connected. The parameter values are either the camera defaults or the last stored value when the camera was used. The descriptions below are with the Xcelera-CL PX4 and the Teledyne DALSA Falcon camera.

- **Device Selector:** Two drop menus to select which device and which saved configuration to use.
 - **Device:** Select which acquisition device to control and configure a camera file for. Required in cases where there are multiple boards in a system and also when one board supports multiple acquisition types. Note in this example, the X64 Xcelera-CL PX4 was installed with firmware to support a monochrome Camera Link camera.
 - **Configuration:** Select the timing for a specific camera model included with the Sopera installation or a standard video standard. The *User's* subsection is where user created camera files are stored.

- **Parameter Groups:** Select a function category and change parameter values as required. Descriptions for the camera parameters change dependent on the camera. The following information was obtained by using a Teledyne DALSA Falcon camera.
 - **Camera Information:** Provides static camera parameters along with a dialog to save a user setup.
 - **Camera Control:** Basic and advanced parameters used to define the timing and pixel type of the camera. Select the pixel mode, Horizontal active resolution, Vertical Resolution (for area scan sensors), Pixel Clock frequency, Camera sensor readout type, Binning, etc. dependent on the camera used. This group is sufficient to configure a free-running camera.
 - **External Trigger:** Parameters to configure the external trigger characteristics.
 - **Image Buffer and ROI:** Control of the host buffer dimension and format.
- **Display:** An important component of CamExpert is its live acquisition display window which allows immediate verification of timing or control parameters without the need to run a separate acquisition program. **Grab** starts continuous acquisition (button then toggles to **Freeze** to stop). **Snap** is a single frame grab. **Trigger** is a software trigger to emulate an external source.
- **Output Messages and Video Status Bar:** Events and errors are logged for review. Camera connection status is displayed where green indicates signal present.
- **Camera Link Serial Command:** Select this Tab to open a serial command port to the camera. This allows the user to issue configuration commands if supported by the camera.

For context sensitive help click on the  button then click on a camera configuration parameter. A short description of the configuration parameter will be shown in a popup. Click on the  button to open the help file for more descriptive information on CamExpert.

CamExpert Demonstration and Test Tools

The CamExpert utility also includes a number of demonstration features which make CamExpert the primary tool to configure, test and calibrate your camera and imaging setup. Display tools include, image pixel value readout, image zoom, and line profiler.

Functional tools include hardware Flat Field calibration and operation support (see "Using the Flat Field Correction Tool" on page 30), plus support for either hardware based or software Bayer filter camera decoding with auto white balance calibration (see "Using the Bayer Filter Tool" on page 33).

Camera Types & Files Applicable to the X64 Xcelera-CL PX4

The X64 Xcelera-CL PX4 supports digital area scan or linescan cameras using the Camera Link interface standard. See "X64 Xcelera-CL PX4 End Bracket Detail" on page 63 for information on connecting a Camera Link camera.

Contact Teledyne DALSA or browse our web site [<http://www.teledynedalsa.com/imaging/support/>] for the latest information and application notes on X64 Xcelera-CL PX4 supported cameras.

Camera Files Distributed with Sopera

The Sopera distribution CDROM includes camera files for a selection of X64 Xcelera-CL PX4 supported cameras. Using the Sopera CamExpert program, you may use the camera files (CCA) provided to generate a camera configuration file (CCF) that describes the desired camera and frame grabber configuration..

Teledyne DALSA continually updates a camera application library composed of application information and prepared camera files. Camera files are ASCII text and can be read with Windows Notepad on any computer without having Sopera installed.

Overview of Sopera Acquisition Parameter Files (*.ccf or *.cca/*.cvi)

Concepts and Differences between the Parameter Files

There are two components to the legacy Sopera acquisition parameter file set: CCA files (also called cam-files) and CVI files (also called VIC files, i.e. video input conditioning). The files store video-signal parameters (CCA) and video conditioning parameters (CVI), which in turn simplifies programming the frame-grabber acquisition hardware for the camera in use. **Sopera LT 5.0** introduces a new camera configuration file (**CCF**) that combines the CCA and CVI files into one file.

Typically, a camera application will use a CCF file per camera operating mode (or one CCA file in conjunction with several CVI files, where each CVI file defines a specific camera operating mode). An application can also have multiple CCA/CCF files so as to support different image format modes supported by the camera or sensor (such as image binning or variable ROI).

CCF File Details

Files using the ".CCF" extension, (Camera Configuration files), are essentially the camera (CCA) and frame grabber (CVI) parameters grouped into one file for easier configuration file management. This is the default Camera Configuration file used with Sopera LT 5.0 and the CamExpert utility.

CCA File Details

Teledyne DALSA distributes camera files using the ".CCA" extension, (CAMERA files), which contain all parameters describing the camera video signal characteristics and operation modes (what the camera outputs). The Sopera parameter groups within the file are:

- Video format and pixel definition.
- Video resolution (pixel rate, pixels per line, lines per frame).
- Synchronization source and timing.
- Channels/Taps configuration.
- Supported camera modes and related parameters.
- External signal assignment.

CVI File Details

Legacy files using the ".CVI" extension contain all operating parameters related to the frame grabber board - what the frame grabber can actually do with camera controls or incoming video. The Sopera parameter groups within the file are:

- Activate and set any supported camera control mode or control variable.
- Define the integration mode and duration.
- Define the strobe output control.
- Allocate the frame grabber transfer ROI, the host video buffer size and buffer type (RGB888, RGB101010, MONO8, MONO16).
- Configuration of line/frame trigger parameters such as source (internal via the frame grabber /external via some outside event), electrical format (TTL, RS-422, OPTO-isolated), and signal active edge or level characterization.

Camera Interfacing Check List

Before interfacing a camera from scratch with CamExpert:

- Confirm that Teledyne DALSA has not already published an application note with camera files [<http://www.teledynedalsa.com/imaging/support/>].
- Confirm that the correct version or board revision of X64 Xcelera-CL PX4 is used. Confirm that the required firmware is loaded into the X64 Xcelera-CL PX4 .
- Confirm that Sopera does not already have a .cca file for your camera installed on your hard disk. If there is a .cca file supplied with Sopera, then use CamExpert to automatically generate the .ccf file with default parameter values matching the frame grabber capabilities.
- Check if the Sopera installation has a similar type of camera file. A similar .cca file can be loaded into CamExpert where it is modified to match timing and operating parameters for your camera, and lastly save them as Camera Configuration file (.ccf).
- Finally, if your camera type has never been interfaced, run CamExpert after installing Sopera and the acquisition board driver, select the board acquisition server, and manually enter the camera parameters.

Using the Flat Field Correction Tool

Flat Field Correction is the process of eliminating small gain differences between pixels in a sensor array. That sensor when exposed to a uniformly lit field will have no gray level differences between pixels when calibrated flat field correction is applied to the image. The CamExpert Flat Field tool functions with hardware supporting flat field processing.

X64 Xcelera-CL PX4 Flat Field Support

The X64 Xcelera-CL PX4 supports hardware based real-time Flat Field Correction when used with its dual Base or one Medium configuration.

Important: Flat field and flat line correction impose limitations to the maximum acquisition frame rate. Please contact the Teledyne DALSA support group for more details on camera specific maximum supported acquisition rates.

Loading the Required Camera File

Select the required camera configuration file for the connected camera. Verify the acquisition with the live grab function. Make camera adjustments to get good images.

Set up Dark and Bright Acquisitions with the Histogram Tool

Before performing calibration, verify the acquisition with a live grab. Also at this time make preparations to grab a flat light gray level image, required for the calibration, such as a clean evenly lighted white wall or non-glossy paper with the lens slightly out of focus. Ideally a controlled diffused light source aimed directly at the lens should be used. Note the lens iris position for a bright but not saturated image. Additionally check that the lens iris closes well or have a lens cover to grab the dark calibration image.

Verify a Dark Acquisition

Close the camera lens iris and cover the lens with a lens cap. Using CamExpert, click on the grab button and then the histogram button. The following figure shows a typical histogram for a very dark image.

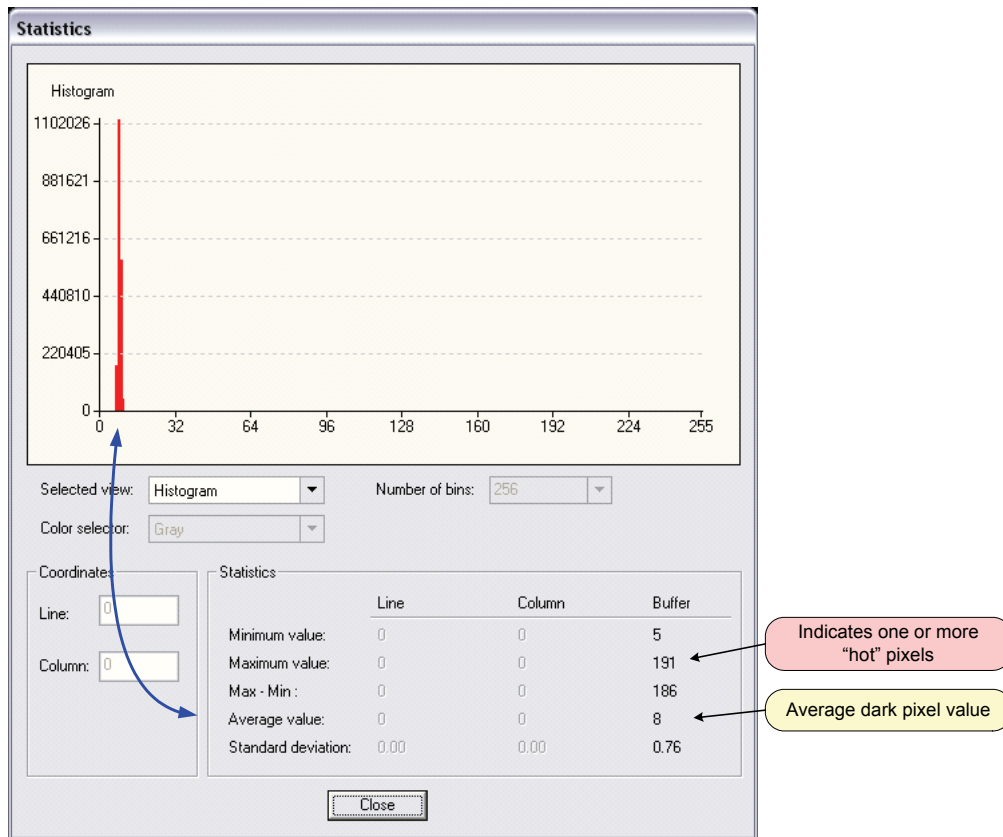

Important: In this example, the **average** pixel value for the frame is close to black. Also note that most sensors will show a much higher maximum pixel value due to one or more "hot pixels". The sensor specification accounts for a small number of hot or stuck pixels (pixels that do not react to light over the full dynamic range specified for that sensor).

Verify a Bright Acquisition

Aim the camera at a diffused light source or evenly lit white wall with no shadows falling on it. Using CamExpert, click on the grab button and then the histogram button. Use the lens iris to adjust for a bright gray approximately around a pixel value of 200 (for 8-bit pixels). The following figure shows a typical histogram for a bright gray image.

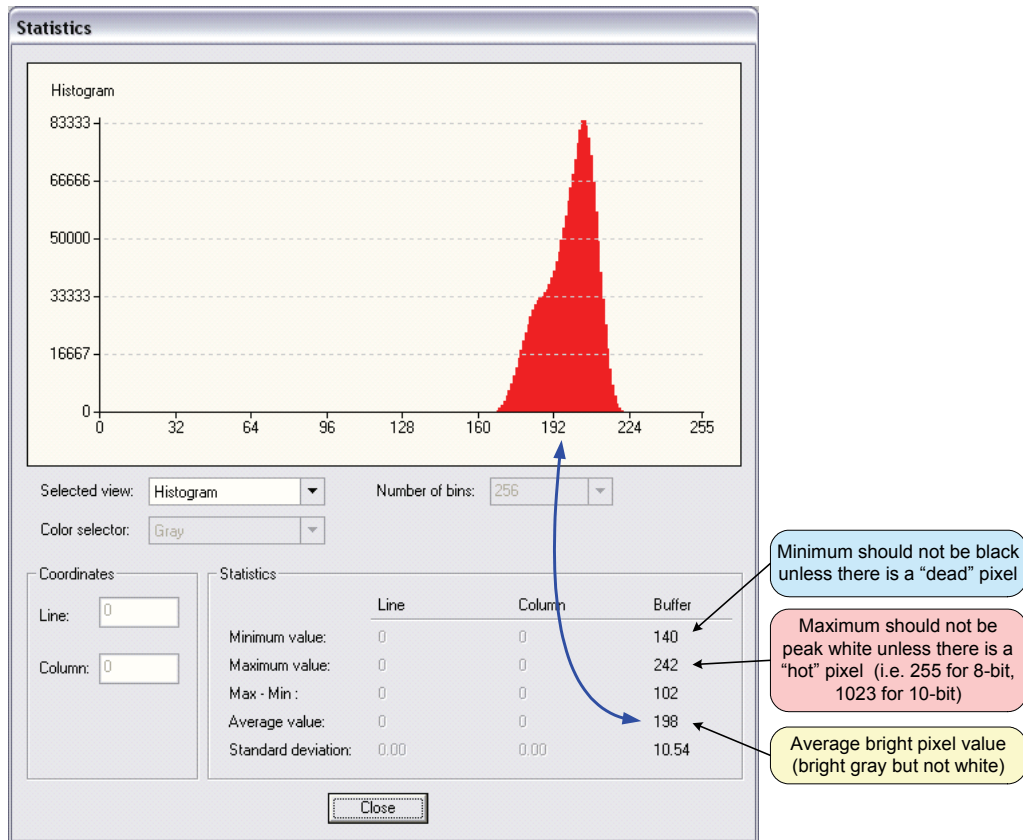

Important: In this example, the **average** pixel value for the frame is bright gray. Also note that sensors may show a much higher maximum or a much lower minimum pixel value due to one or more "hot or dead pixels". The sensor specification accounts for a small number of hot, stuck, or dead pixels (pixels that do not react to light over the full dynamic range specified for that sensor).

Once the bright gray acquisition setup is done, note the camera position and lens iris position so as to be able to repeat it during the calibration procedure.

Flat Field Correction Calibration Procedure

Calibration is the process of taking two reference images, one of a black field – one of a light gray field (not saturated), to generate correction data for images captured by the CCD. Each CCD pixel data is modified by the correction factor generated by the calibration process, so that each pixel now has an identical response to the same illumination.

Start the Flat Field calibration tool via the CamExpert menu bar:

Tools • Flat Field Correction • Calibration.

Flat Field Calibration Window

The Flat Field calibration window provides a three step process to acquire two reference images and then save the flat field correction data for the camera used. To aid in determining if the reference images are valid, a histogram tool is provided so that the user can review the images used for the correction data.

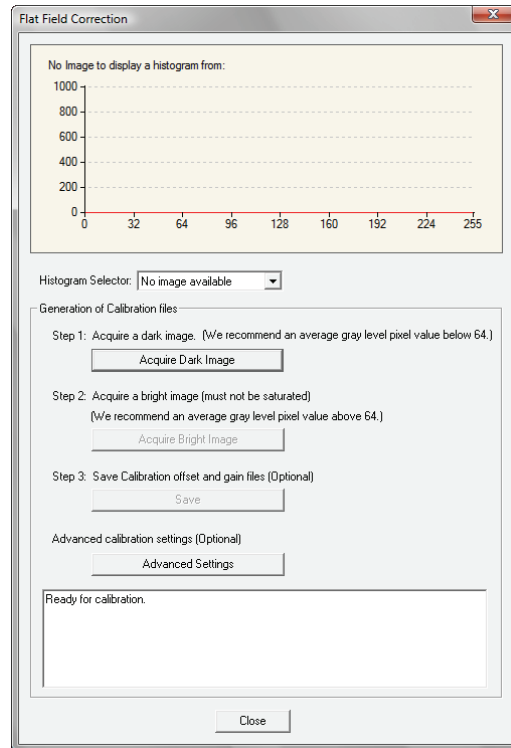

- Setup the camera to capture a uniform black image. Black paper with no illumination and the camera lens' iris closed to minimum can provide such a black image.
- Click on **Acquire Black Image**. The flat field demo will grab a video frame, analyze the pixel gray level spread, and present the statistics. The desired black reference image should have pixel values less than 20. If acceptable accept the image as the black reference.
- Setup the camera to acquire a uniform white image (but not saturated white). Even illumination on white paper can be used, with a gray level of 128 minimum. It is preferable to prepare for the white level calibration before the calibration procedure.
- Click on **Acquire White Image**. The flat field demo will grab a video frame, analyze the pixel gray level spread, and present the statistics. The captured gray level for all pixels should be greater than 128. If acceptable accept the image as the white reference.
- Click on **Save**. The flat field correction data is saved as a TIF image with a file name of your choice (such as camera name and serial number).

Using Flat Field Correction

From the CamExpert menu bar enable Flat Field correction (**Tools • Flat Field Correction • Enable**). Now when doing a live grab or snap, the incoming image is corrected by the current flat field calibration data for each pixel.

Use the menu function **Tools • Flat Field Correction • Load** to load in a flat field correction image from a previous saved calibration data. CamExpert allows saving and loading calibration data for all cameras used with the imaging system.

Using the Bayer Filter Tool

CamExpert supports the use of Bayer Filter cameras by providing a tool to select the Bayer filter mosaic pattern and to perform an auto white balance. Color calibration can then be manually fine tuned with RGB gain and gamma adjustments.

The CamExpert Bayer filter tool supports using both software or hardware based decoding. With boards that have Bayer filter decoding in hardware such as the X64 Xcelera-CL PX4 (requires loading the Bayer Decoder firmware), CamExpert directly controls the hardware for high performance real-time acquisitions from Bayer filter cameras. When standard acquisition boards are used, CamExpert performs software Bayer filter decoding using the host system processor.

Bayer Filter White Balance Calibration Procedure

The following procedure uses an X64 Xcelera-CL PX4 with hardware Bayer filter support (Bayer Decoder firmware loaded) and any supported Bayer color camera. It is assumed that CamExpert was used to generate a camera file with correct camera timing parameters.

- On the CamExpert menu bar, click on **Tools • Bayer Filter**. The following menu should show **Hardware** selected by default when the X64 Xcelera-CL PX4 has Bayer support.
- Select **Setting** to access the color calibration window (see following figure).

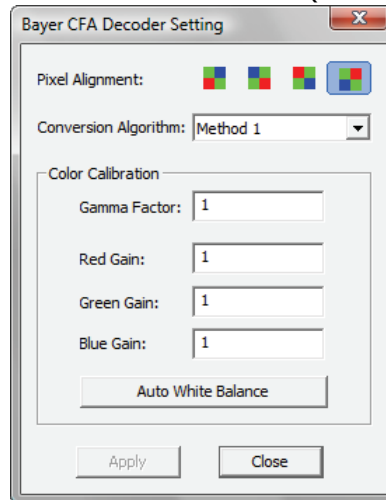

- Click **Grab** to start live acquisition.
- Aim and focus the camera. The camera should see an area of white or place white paper in front of the object being imaged.
- Click on one of the four Bayer pixel alignment patterns to match the camera (best color before calibration). Typically the CamExpert default is correct for a majority of cameras.
- Adjust the lens iris to reduce the exposure brightness so that the white image area is now darker. Make certain that no pixel in the white area is saturated.
- Using the mouse left button, click and drag a ROI enclosing a portion of the white area.
- Click on the **Auto White Balance** button. CamExpert will make RGB gain adjustments.
- Open the camera iris to have a correctly exposed image.
- Review the image for color balance.
- Manually make additional adjustments to the RGB gain values. Fine tune the color balance to achieve best results. Adjust the gamma factor to additionally improve the display.
- Stop the live acquisition and save camera file (which now contains the Bayer RGB calibration information). Note that the gamma factor is not save because it is not a Sopera parameter but only a display tool.

Using the Bayer Filter

A Sopera application, when loading the camera file parameters, will have the RGB gain adjustment values. The application can provide the calibration window to make RGB adjustments as required.

Sapera Demo Applications

Grab Demo Overview

Program	Start•Programs•Teledyne DALSA •Sapera LT•Demos•Frame Grabbers•Grab Demo
Program file	... \Sapera\Demos\Classes\vc\GrabDemo\Release\GrabDemo.exe
Workspace	... \Sapera\Demos\Classes\vc\SapDemos.dsw
.NET Solution	... \Sapera\Demos\Classes\vc\SapDemos_2003.sln ... \Sapera\Demos\Classes\vc\SapDemos_2005.sln ... \Sapera\Demos\Classes\vc\SapDemos_2008.sln
Description	This program demonstrates the basic acquisition functions included in the Sapera library. The program allows you to acquire images, either in continuous or in one-shot mode, while adjusting the acquisition parameters. The program code may be extracted for use within your own application.
Remarks	This demo is built using Visual C++ 6.0. It is based on Sapera C++ classes. See the Sapera User's and Reference manuals for more information.

Using the Grab Demo

Server Selection

Run the grab demo from the start menu **Start•All Programs•Teledyne DALSA•Sapera LT•Demos•Frame Grabbers•Grab Demo**.

The demo program first displays the acquisition configuration menu. The first drop menu displayed permits selecting from any installed Sapera acquisition servers (installed Teledyne DALSA acquisition hardware using Sapera drivers). The second drop menu permits selecting from the available input devices present on the selected server.

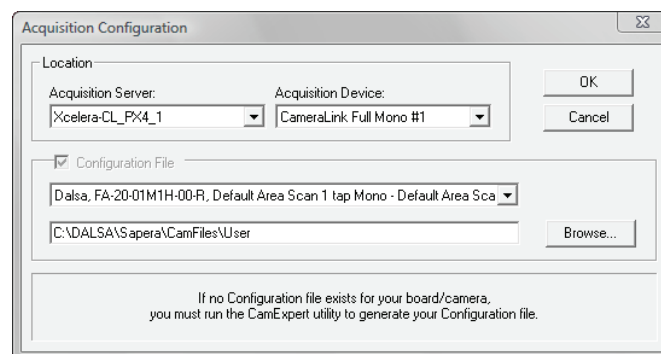

CCF File Selection

The acquisition configuration menu is also used to select the required camera configuration file for the connected camera. Sapera camera files contain timing parameters and video conditioning parameters. The default folder for camera configuration files is also used by the CamExpert utility to save user generated or modified camera files.

Use the Sapera CamExpert utility program to generate the camera configuration file based on timing and control parameters entered. The CamExpert live acquisition window allows immediate verification of those parameters. CamExpert reads both Sapera *.cca and *.cvi for backward compatibility with the original Sapera camera files.

Grab Demo Main Window

The Grab Demo program provides basic acquisition control for the selected frame grabber. Frame buffer defaults are defined by the loaded camera file (.ccf).

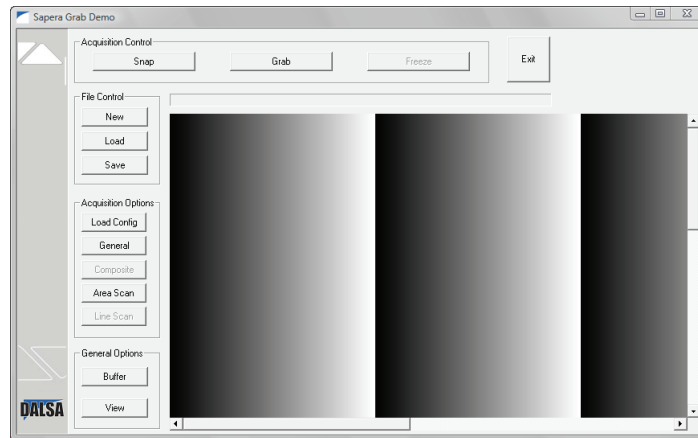

Refer to the Sapera LT User's Manual (OC-SAPM-USER), in section "Demos and Examples – Acquiring with Grab Demo", for more information on the Grab Demo.

Flat-Field Demo Overview

Program	Start•Programs•Teledyne DALSA•Sapera LT•Demos•Frame Grabbers•Flat Field Demo
Program file	... \Sapera \Demos \Classes \vc \FlatFieldDemo \Release \FlatfieldDemo.exe
Workspace	... \Sapera \Demos \Classes \vc \SapDemos.dsw
Description	This program demonstrates Flat Field or Flat Line processing, either performed by supporting Teledyne DALSA hardware or performed on the host system via the Sapera library. The program allows you to acquire a flat field or flat line reference image, and then do real time correction either in continuous or single acquisition mode. The program code may be extracted for use within your own application.
Remarks	This demo is built using Visual C++ 6.0. It is based on Sapera C++ classes. See the Sapera User's and Reference manuals for more information.

Using the Flat Field Demo

Refer to the Sapera LT User's Manual (OC-SAPM-USER), in section "Using the Flat Field Demo", for more information.

X64 Xcelera-CL PX4 Reference

Full Block Diagram

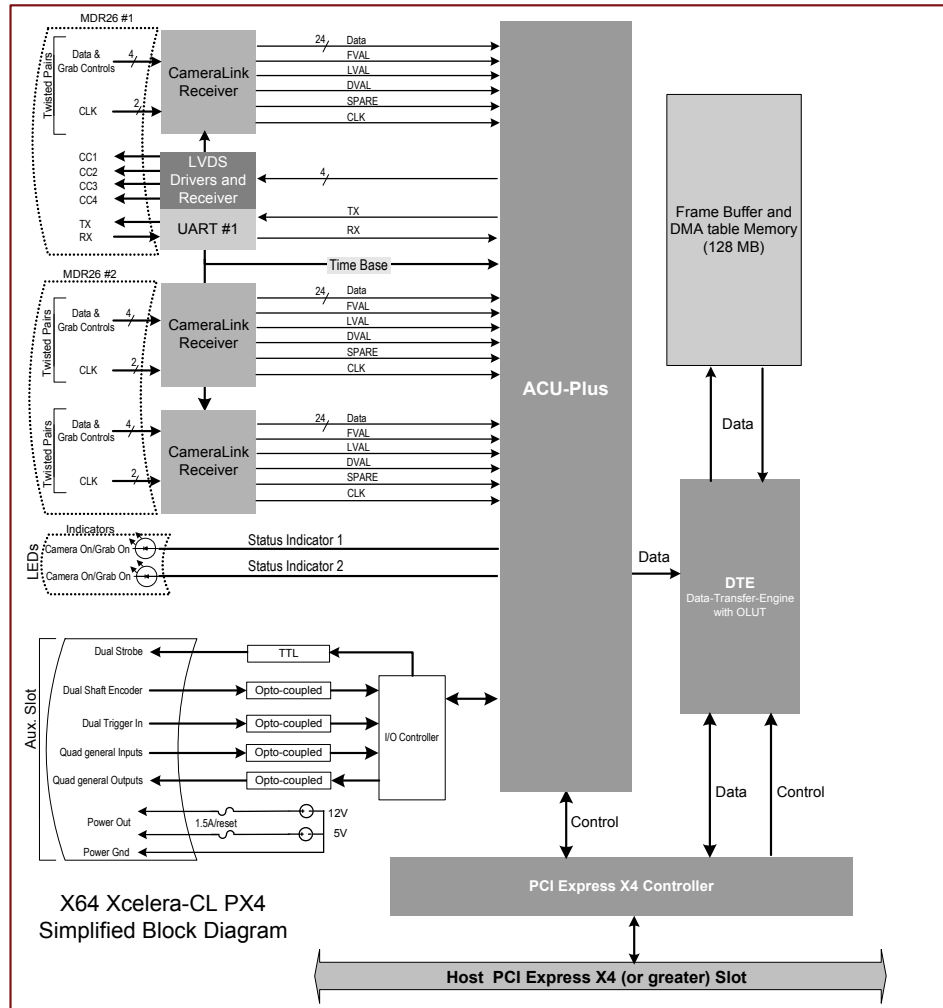

Acquisition Timing

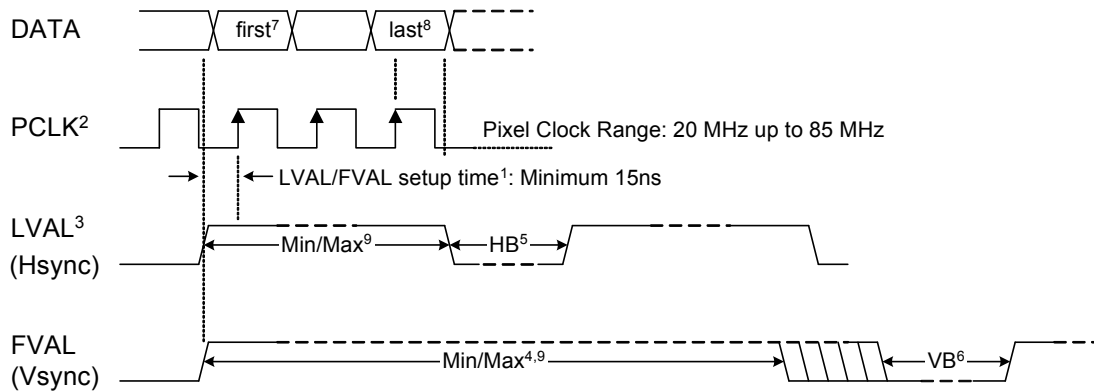

- ¹ The setup times for LVAL and FVAL are the same. Both must be high and stable before the rising edge of the Pixel Clock.
- ² Pixel Clock must always be present.
- ³ LVAL must be active high to acquire camera data.
- ⁴ Minimum of 1.
 - ⁵ HB - Horizontal Blanking:

Minimum: 1 clock cycle	▪ ⁶ VB - Vertical Blanking:
Maximum: no limits	Minimum: 1 line
	Maximum: no limits
- ⁷ First Active Pixel (unless otherwise specified in the CCA file - "Horizontal Back invalid = x" where 'x' defines the number of pixels to be skipped).
- ⁸ Last Active Pixel - defined in the CCA file under "Horizontal active = y" - where 'y' is the total number of active pixels per tap.
- ⁹ Maximum Valid Data:
 - 8-bits/pixel x 256K Pixels/line (LVAL)
 - 16-bits/pixel x 128K Pixels/line (LVAL)
 - 32-bits/pixel x 64K Pixels/line (LVAL)
 - 64-bits/pixel x 32K Pixels/line (LVAL)
 - 16 Millions lines (FVAL)

Line Trigger Source Selection for Linescan Applications

Linescan imaging applications require some form of external event trigger to synchronize linescan camera exposures to the moving object. This synchronization signal is either an external trigger source (one exposure per trigger event) or a shaft encoder source composed of a single or dual phase (quadrature) signal.

The X64 Xcelera-CL PX4 shaft encoder inputs provide additional functionality with pulse drop, pulse multiply, and pulse direction support, along with error trapping event notifications such as "External Line Trigger Too Fast" (see Supported Events and Transfer Methods).

The following table describes the line trigger source types supported by the X64 Xcelera-CL PX4. Refer to the Sopera Acquisition Parameters Reference Manual (OC-SAPM-APR00) for descriptions of the Sopera parameters.

CORACQ_PRM_EXT_LINE_TRIGGER_SOURCE

Full description relative to trigger type and X64 Xcelera-CL PX4 configuration used:

PRM Value	Configuration & input used	External Line Trigger Signal used	External Shaft Encoder Signal used
		<i>if</i> CORACQ_PRM_EXT_LINE_TRIGGER_ENABLE = <i>true</i>	<i>if</i> CORACQ_PRM_SHAFT_ENCODER_ENABLE = <i>true</i>
0	Dual - Camera #1 Dual - Camera #2 Full - Camera #1	Shaft Encoder Phase A Shaft Encoder Phase B Shaft Encoder Phase A	Shaft Encoder Phase A Shaft Encoder Phase B Shaft Encoder Phase A & B
1	Dual - Camera #1 Dual - Camera #2 Full - Camera #1	Shaft Encoder Phase A Shaft Encoder Phase A Shaft Encoder Phase A	Shaft Encoder Phase A Shaft Encoder Phase A Shaft Encoder Phase A
2	Dual - Camera #1 Dual - Camera #2 Full - Camera #1	Shaft Encoder Phase B Shaft Encoder Phase B Shaft Encoder Phase B	Shaft Encoder Phase B Shaft Encoder Phase B Shaft Encoder Phase B
3, 5, 6, 7	Dual - Camera #1 Dual - Camera #2 Full - Camera #1	n/a n/a n/a	Shaft Encoder Phase A & B Shaft Encoder Phase A & B Shaft Encoder Phase A & B
4	Dual-Camera #1 Dual-Camera #2 Full-Camera #1	From Board Sync From Board Sync From Board Sync	From Board Sync From Board Sync From Board Sync

See "J4: External Signals Connector " on page 69 for shaft encoder input connector details.

CVI/CCF File Parameters Used

- External Line Trigger Source = prm value
- External Line Trigger Enable = true/false
- Shaft Encoder Enable = true/false

Shaft Encoder Interface Timing

Connector J4, Dual Balanced Shaft Encoder Inputs:

- Input 1: Pin 23 (Phase A +) & Pin 24 (Phase A -)
(see "J4: External Signals Connector " on page 69 for complete connector signal details)
- Input 2: Pin 25 (Phase B +) & Pin 26 (Phase B -)
- See "External Signals Connector Bracket Assembly" on page 74 for pinout information about the DB37 used for external connections.

Web inspection systems with variable web speeds typically provide one or two synchronization signals from a web mounted encoder to coordinate trigger signals. These trigger signals are used by the acquisition linescan camera. The X64 Xcelera-CL PX4 supports single or dual shaft encoder signals. Dual encoder signals are typically 90 degrees out of phase relative to each other and provide greater web motion resolution.

Example using any Encoder Input with Pulse-drop Counter

When enabled, the camera is triggered and acquires one scan line for each shaft encoder pulse edge. To optimize the web application, a second Sapera parameter defines the number of triggers to skip between valid acquisition triggers. The figure below depicts a system where a valid camera trigger is any pulse edge from either shaft encoder signal. After a trigger the two following triggers are ignored (as defined by the Sapera pulse drop parameter).

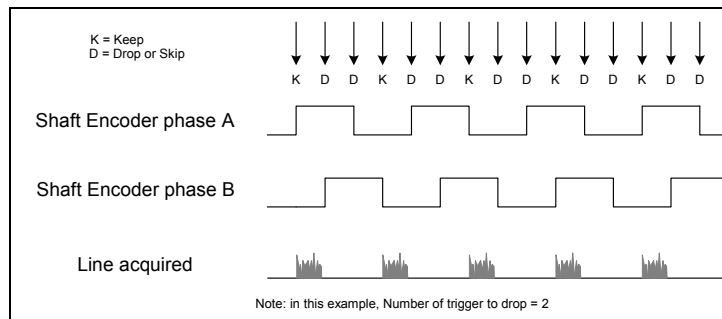

Example using Sequential Encoder Input

Support of a dual phase encoder should consider the direction of motion of one phase signal to the other. Such a case might exist where system vibrations and/or conveyor backlash can cause the encoder to briefly travel backwards. The acquisition device must in those cases count the reverse steps and subtract the forward steps such that only pulses after the reverse count reaches zero are considered. By using the event "Shaft Encoder Reverse Counter Overflow", an application can monitor an overflow of this counter. Also, if one wants to trigger a camera at its maximum line rate using a high jitter shaft encoder, the parameter CORACQ_PRM_LINE_TRIGGER_AUTO_DELAY can be used to delay automatically line triggers to the camera to avoid over-triggering a camera, and thus not miss a line. Note that some cameras integrate this feature. See also the event "Line Trigger Too Fast" that can be enabled when using the 'auto delay' feature.

The example figure below shows shaft encoder signals with high jitter. If the acquisition is triggered when phase B follows phase A, with jitter present phase B may precede phase A. Use of the *Shaft Encoder Direction* parameter will prevent false trigger conditions.

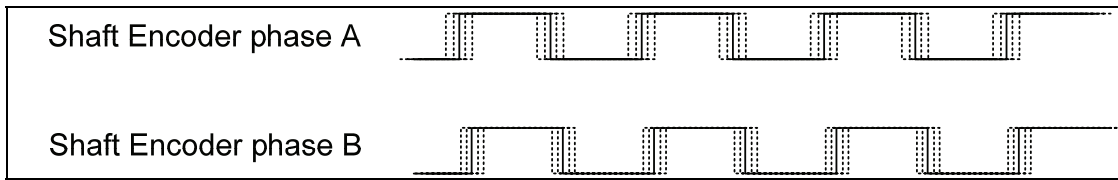

Figure 3: Using Shaft Encoder Direction Parameter



Note: Camera file parameters are best modified by using the Sapera CamExpert program.

CVI/CCF File Parameters Used

Shaft Encoder Enable = X, where:

- If X = 1, Shaft Encoder is enabled
- If X = 0, Shaft Encoder is disabled

Shaft Encoder Pulse Drop = X, where:

- X = number of trigger pulses ignored between valid triggers

Shaft Encoder Pulse Multiply = X, where:

- X = number of trigger pulses generated for each shaft encoder pulses

Shaft Encoder Direction = X, where:

- X = 0, Ignore direction
- X = 1, Forward steps are detected by pulse order A/B (forward motion)
- X = 2, Forward steps are detected by pulse order B/A (reverse motion)



Note: The Multiply operation is done first, followed by the drop operation. For information on camera configuration files see the Sapera Acquisition Parameters Reference Manual (OC-SAPM-APR00).

Virtual Frame Trigger for Lines Scan Cameras

When using line scan cameras a frame buffer is allocated in host system memory to store captured video lines. To control when a video line is stored as the first line in this “virtual” frame buffer, an external frame trigger signal is used. The number of lines sequentially grabbed and stored in the virtual frame buffer is controlled by the Sapera vertical cropping parameter.

Virtual Frame Trigger Timing Diagram

The following timing diagram shows an example of grabbing 10 video lines from a line scan camera and the use of a virtual frame trigger to define when a video line is stored at the beginning of the virtual frame buffer. The virtual frame trigger signal (generated by some external event) is input on the X64 Xcelera-CL PX4 trigger input.

- Virtual frame trigger can be 24V industry standard, TTL 5V or RS-422 and be rising or falling edge active, active high or low, or double pulse rising or falling edge.
- Virtual frame trigger control is configured for rising edge trigger in this example.
- Virtual frame trigger connects to the X64 Xcelera-CL PX4 via the External Trigger Input 1 & 2 balanced inputs:
 - Trigger Input #1 on connector J4 pin 19 (+) and 20 (-).
 - Trigger Input #2 on connector J4 pin 21 (+) and 22 (-).
- Two types of external connector brackets are available to bring out signals from the J4 connector.
- Camera control signals are active at all times. These continually trigger the camera acquisition in order to avoid corrupted video lines at the beginning of a virtual frame.
 - The camera control signals are either based on timing controls input on one or both X64 Xcelera-CL PX4 shaft encoder inputs (see “J4: External Signals Connector ” on page 69 pinout) or line triggers generated internally by the X64 Xcelera-CL PX4.
 - The number of lines captured is specified by the Sapera vertical cropping parameter.

Synchronization Signals for a Virtual Frame of 10 Lines.

The following timing diagram shows the relationship between external Frame_Reset input, external Shaft Encoder input (one phase used with the second terminated), and EXSYNC out to the camera.

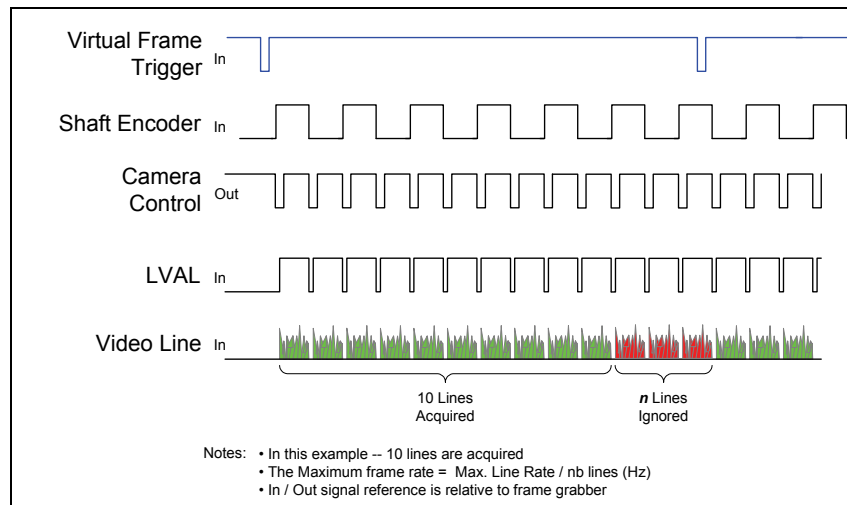

CVI File (VIC) Parameters Used

The VIC parameters listed below provide the control functionality for virtual frame reset. Applications either load pre-configured .cvi files or change VIC parameters directly during runtime.



Note: Camera file parameters are best modified by using the Sapera CamExpert program.

External Frame Trigger Enable = X, where: (with Virtual Frame Trigger enabled)

- If X = 1, External Frame Trigger is enabled
- If X = 0, External Frame Trigger is disabled

External Frame Trigger Detection = Y, where: (with Virtual Frame Trigger edge select)

- If Y= 1, External Frame Trigger is active low
 - If Y= 2, External Frame Trigger is active high
- If Y= 4, External Frame Trigger is active on rising edge
- If Y= 8, External Frame Trigger is active on falling edge
 - If Y= 32, External Frame Trigger is dual-input rising edge
 - If Y= 64, External Frame Trigger is dual-input falling edge
-

External Frame Trigger Level = Z, where: (with Virtual Frame Trigger signal type)

- If Z= 2, External Frame Trigger is a RS-422 signal



Note: For information on camera files see the Sopera Acquisition Parameters Reference Manual (OC-SAPM-APR00).

Acquisition Methods

Sopera acquisition methods define the control and timing of the camera and frame grabber board. Various methods are available, grouped as:

- Camera Trigger Methods (method 1 and 2 supported)
- Camera Reset Methods (method 1 supported)
- Line Integration Methods (method 1 through 4, 7 supported)
- Time Integration Methods (method 1 through 9 supported)
- Strobe Methods (method 1 through 4 supported)

Refer to the Sopera LT Acquisition Parameters Reference manual (OC-SAPM-APR00) for detailed information concerning camera and acquisition control methods.

Trigger to Image Reliability

Trigger-to-image reliability incorporates all stages of image acquisition inside an integrated controller to increase reliability and simplify error recovery. The trigger-to-image reliability model brings together all the requirements for image acquisition to a central management unit. These include signals to control camera timing, on-board frame buffer memory to compensate for PCI bus latency, and comprehensive error notification. If the X64 Xcelera-CL PX4 detects a problem, the application can take appropriate action to return to normal operation.

The X64 Xcelera-CL PX4 is designed with a robust ACU (Acquisition and Control Unit). The ACU monitors in real-time, the acquisition state of the input plus the DTE (Data Transfer Engine) which transfers image data from on-board memory into PC memory. In general, these management processes are transparent to end-user applications. With the X64 Xcelera-CL PX4, applications ensure trigger-to-image reliability by monitoring events and controlling transfer methods as described below:

Supported Events and Transfer Methods

Listed below are the supported acquisition and transfer events. Event monitoring is a major component to the Trigger-to-Image Reliability framework.

Acquisition Events

Acquisition events are related to the acquisition module. They provide feedback on the image capture phase.

- **External Trigger (Used/Ignored)**
Generated when the external trigger pin is asserted, usually indicating the start of the acquisition process. There are 2 types of external trigger events: 'Used' or 'Ignored'. Following an external trigger, if the event generates a captured image, an External Trigger Used event will be generated (CORACQ_VAL_EVENT_TYPE_EXTERNAL_TRIGGER). If there is no captured image, an External Trigger Ignored event will be generated (CORACQ_VAL_EVENT_TYPE_EXTERNAL_TRIGGER_IGNORED). An external trigger event will be ignored if the rate at which the events are received are higher than the possible frame rate of the camera.
- **Start of Frame**
Event generated, during acquisition, when the connected sensor video frame start is detected by the board acquisition hardware. The Sopera event value is CORACQ_VAL_EVENT_TYPE_START_OF_FRAME.
- **End of Frame**
Event generated, during acquisition, when the connected sensor video frame end is detected by the board acquisition hardware. The Sopera event value is CORACQ_VAL_EVENT_TYPE_END_OF_FRAME.
- **Data Overflow**
The Data Overflow event indicates that there is not enough bandwidth for the acquired data to be transferred without loss. This is usually caused by limitations of the acquisition module and should never occur.
The Sopera event value is CORACQ_VAL_EVENT_TYPE_DATA_OVERFLOW.
- **Frame Valid**
Event generated when the connected sensor video frame start is detected by the board acquisition hardware. Acquisition does not need to be started, therefore this event can verify a valid signal is connected. The Sopera event value is CORACQ_VAL_EVENT_TYPE_VERTICAL_SYNC.
- **Pixel Clock (Present/Absent)**
Event generated on the transition from detecting or not detecting a pixel clock signal. The Sopera event values are CORACQ_VAL_EVENT_TYPE_NO_PIXEL_CLK and CORACQ_VAL_EVENT_TYPE_PIXEL_CLK.
- **Frame Lost**
The Frame Lost event indicates that an acquired image could not be transferred to on-board memory. An example of this case would be if there are no free on-board buffers available for the new image. This may be the case if the image transfer from onboard buffers to host PC memory cannot be sustained due to bus bandwidth issues.
The Sopera event value is CORACQ_VAL_EVENT_TYPE_FRAME_LOST.
- **Vertical Timeout**
This event indicates a timeout situation where a camera fails to output a video frame after a trigger. The Sopera event value is CORACQ_VAL_EVENT_VERTICAL_TIMEOUT.
- **External Line Trigger Too Slow**
Event which indicates that the detected shaft encoder input tick rate is too slow for the device to take into account the specified shaft encoder multiplier value. The Sopera event value is CORACQ_VAL_EVENT_TYPE_EXT_LINE_TRIGGER_TOO_SLOW.
- **Line Trigger Too Fast**
Event which indicates a previous line-trigger did not generate a complete video line from the camera. Note that due to jitter associated with using shaft encoders, the acquisition device can delay a line trigger if a previous line has not yet completed. This event is

generated if a second line trigger comes in while the previous one is still pending. This event is generated once per virtual frame. The Sapera event value is `CORACQ_VAL_EVENT_TYPE_LINE_TRIGGER_TOO_FAST`.

- **Shaft Encoder Reverse Count Overflow**

Event which indicates that the shaft encoder has travelled in the opposite direction expected and that the number of pulses encountered during that travel has exceeded the acquisition device counter. The acquisition device will thus not be able to skip the appropriate number of pulses when the expected direction is detected. The Sapera event value is `CORACQ_VAL_EVENT_TYPE_SHAFT_ENCODER_REVERSE_COUNT_OVERFLOW`

Transfer Events

Transfer events are the ones related to the transfer module. Transfer events provide feedback on image transfer from onboard memory frame buffers to PC memory frame buffers.

- **Start of Frame**

The Start of Frame event is generated when the first image pixel is transferred from onboard memory into PC memory.

The Sapera event value is `CORXFER_VAL_EVENT_TYPE_START_OF_FRAME`.

- **End of Frame**

The End of Frame event is generated when the last image pixel is transferred from onboard memory into PC memory.

The Sapera event value is `CORXFER_VAL_EVENT_TYPE_END_OF_FRAME`.

- **End of Line**

The End of Line event is generated after a video line is transferred to a PC buffer.

The Sapera event value is `CORXFER_VAL_EVENT_TYPE_END_OF_LINE`.

- **End of N Lines**

The End of N Lines event is generated after a set number of video lines are transferred to a PC buffer. The Sapera event value is `CORXFER_VAL_EVENT_TYPE_END_OF_NLINES`.

- **End of Transfer**

The End of Transfer event is generated at the completion of the last image being transferred from onboard memory into PC memory. To complete a transfer, a stop must be issued to the transfer module (if transfers are already in progress). If a transfer of a fixed number of frames was requested, the transfer module will stop transfers automatically. The Sapera event value is `CORXFER_VAL_EVENT_TYPE_END_OF_TRANSFER`.

Trigger Signal Validity

The ACU ignores external trigger signal noise with its programmable debounce control. Program the debounce parameter for the minimum pulse duration considered as a valid external trigger pulse. Refer to “Note 3: External Trigger Input Specifications” on page 71 for more information.

Supported Transfer Cycling Methods

The X64 Xcelera-CL PX4 supports the following transfer modes, which are either synchronous or asynchronous. These definitions are from the Sapera Basic Reference manual.

- `CORXFER_VAL_CYCLE_MODE_SYNCHRONOUS_WITH_TRASH`

Before cycling to the next buffer in the list, the transfer device will check the next buffer's state. If its state is full, the transfer will be done in the trash buffer, which is defined as the last buffer in the list; otherwise, it will occur in the next buffer. After a transfer to the trash buffer is done, the transfer device will check again the state of the next buffer. If it is empty, it will transfer to this buffer otherwise it will transfer again to the trash buffer.

- `CORXFER_VAL_CYCLE_MODE_SYNCHRONOUS_NEXT_EMPTY_WITH_TRASH`

Before cycling to the next buffer in the list, the transfer device will check the next buffer's state. If its state is full, the next buffer will be skipped, and the transfer will be done in the trash buffer, which is defined as the last buffer in the list; otherwise it will occur in the next buffer. After a transfer to the trash is done, the transfer device will check the next buffer in the list, if its state is empty, it will transfer to this buffer otherwise it will skip it, and transfer again to the trash buffer.

- CORXFER_VAL_CYCLE_MODE_ASYNCHRONOUS
The transfer device cycles through all buffers in the list without concern about the buffer state.

Output LUT Availability

The following table defines the X64 Xcelera-CL PX4 Output LUT (look up tables) availability. Note that unsupported modes are not listed.

Number of Digital Bits	Number of Taps Full	Number of Taps Medium	Number of Taps Dual Base	Output Pixel Format	LUT Format	Notes
8	8	4	3	MONO 8	8-in, 8-out	
8	8	4	3	MONO 16		Not Supported
8	10	-	-	MONO 8	8-in, 8-out	
10	4	2	2	MONO 8	10-in, 8-out	
10	4	2	2	MONO 16	10-in, 10-out	10 bits in 10 LSBs of 16-bit
12	4	2	2	MONO 8	12-in, 8-out	8 MSB
12	4	2	2	MONO 16	12-in, 12-out	12 bits in 12 LSBs of 16-bit
8 x 3 (RGB)	2	1	1	RGB8888	8-in, 8-out	
10 x 3 (RGB)	1	1	-	RGB8888 RGB101010 RGB16161616	10-in, 8-out 10-in, 10-out 10-in, 10-out	Medium or Full
12 x 3 (RGB)	1	1	-	RGB8888 RGB101010 RGB16161616	12-in, 8-out 12-in, 10-out 12-in, 12-out	Medium or Full

Supporting Non-Standard Camera Link Cameras

Firmware: Full with Bayer Decoder Method 6

This firmware has been designed to support the Bayer Decoder Method 6. This method is required to decode the output of the Basler Sprint SPL8192 in enhanced mode. Since this is a line scan camera, the frame valid signal is used to indicate which 2 consecutive lines go together to convert the Bayer pixels into RGB pixels. Further more, the parameter `CORACQ_PRM_FIELD_ORDER` is used to determine which line will be considered the 1st one out of the 2 lines within a frame valid. In the specific case of the Basler Sprint SPL8192 camera, the 2 lines within a frame valid must be considered the 1st one, therefore the parameter **`CORACQ_PRM_FIELD_ORDER`** must take the value **`CORACQ_VAL_FIELD_ORDER_FVAL_LINE2`** (=0x10).

The provided `B_Sprint_8192x3600_8Taps_Enhance.ccf` provides a starting point to acquire from this camera, with the following parameters.

- Supports up to 8-tap cameras
- Bayer Decoder Method 6 used on cameras such as Basler Sprint SPL8192
- Frame Valid is used to indicate the beginning of a 2 line sequence from a line scan camera.

X64 Xcelera-CL PX4 Supported Parameters

The tables below describe the Sopera capabilities supported by the X64 Xcelera-CL PX4. Unless specified, each capability applies to both boards or all mode configurations and all acquisition modes.



Note: The information here is subject to change. Capabilities should be verified by the application because new board driver releases may change product specifications.

Specifically the X64 Xcelera-CL PX4 family is described in Sopera as:

- Board Server: `Xcelera-CL_PX4_1`
- Acquisition Module: *dependent on firmware used*

Camera Related Capabilities

Capability	Values
<code>CORACQ_CAP_CONNECTOR_TYPE</code>	<code>CORACQ_VAL_CONNECTOR_TYPE_CAMLINK</code> (0x2)
<code>CORACQ_CAP_CONNECTOR_CAMLINK</code> (Pin - 01, Pin - 02, Pin - 03)	<code>CORACQ_VAL_SIGNAL_NAME_NO_CONNECT</code> (0x1) <code>CORACQ_VAL_SIGNAL_NAME_PULSE0</code> (0x8) <code>CORACQ_VAL_SIGNAL_NAME_PULSE1</code> (0x10) <code>CORACQ_VAL_SIGNAL_NAME_GND</code> (0x4000)
<code>CORACQ_CAP_CONNECTOR_CAMLINK</code> (Pin - 04)	<code>CORACQ_VAL_SIGNAL_NAME_NO_CONNECT</code> (0x1)

Table 1: Camera Related Capabilities

Camera Related Parameters

Parameter	Values
CORACQ_PRM_CHANNEL	<p><i>Medium/Full Mono</i> CORACQ_VAL_CHANNEL_SINGLE (0x1) CORACQ_VAL_CHANNEL_DUAL (0x2)</p> <p><i>Base/Medium RGB Bayer/ 10-taps</i> CORACQ_VAL_CHANNEL_SINGLE (0x1)</p>
CORACQ_PRM_FRAME	CORACQ_VAL_FRAME_PROGRESSIVE (0x2)
CORACQ_PRM_INTERFACE	CORACQ_VAL_INTERFACE_DIGITAL (0x2)
CORACQ_PRM_SCAN	<p>CORACQ_VAL_SCAN_AREA (0x1)</p> <p><i>Bayer not supported EXCEPT Bayer Method 6</i> CORACQ_VAL_SCAN_LINE (0x2)</p>
CORACQ_PRM_SIGNAL	CORACQ_VAL_SIGNAL_DIFFERENTIAL (0x2)
CORACQ_PRM_VIDEO	<p><i>Mono</i> CORACQ_VAL_VIDEO_MONO (0x1)</p> <p><i>color RGB</i> CORACQ_VAL_VIDEO_RGB (0x8)</p> <p><i>Bayer</i> CORACQ_VAL_VIDEO_BAYER (0x10)</p>
CORACQ_PRM_PIXEL_DEPTH	<p><i>mono</i> 8 bits, # LUT = 1, LUT format = CORDATA_FORMAT_MONO8 10 bits, # LUT = 1, LUT format = CORDATA_FORMAT_MONO10 10 bits, # LUT = 1, LUT format = CORDATA_FORMAT_MONO8 12 bits, # LUT = 1, LUT format = CORDATA_FORMAT_MONO12 12 bits, # LUT = 1, LUT format = CORDATA_FORMAT_MONO8 14 bits, # LUT = 0, LUT format = CORDATA_FORMAT_MONO14 16 bits, # LUT = 0, LUT format = CORDATA_FORMAT_MONO16</p> <p><i>color RGB</i> 8 bits, # LUT = 1, LUT format = CORDATA_FORMAT_COLORNI8 10 bits, # LUT = 1, LUT format = CORDATA_FORMAT_COLORNI10 12 bits, # LUT = 1, LUT format = CORDATA_FORMAT_COLORNI12</p> <p><i>Bayer</i> 8 bits, # LUT = 1, LUT format = CORDATA_FORMAT_COLORNI8 10 bits, # LUT = 1, LUT format = CORDATA_FORMAT_COLORNI10 12 bits, # LUT = 0, LUT format = CORDATA_FORMAT_COLORNI10</p> <p><i>Bayer Method 6</i> 8 bits, # LUT = 1, LUT format = CORDATA_FORMAT_COLORNI8</p> <p><i>10-taps</i> 8 bits, # LUT = 1, LUT format = CORDATA_FORMAT_MONO8</p>
CORACQ_PRM_VIDEO_STD	CORACQ_VAL_VIDEO_STD_NON_STD (0x1)
CORACQ_PRM_FIELD_ORDER	<p>CORACQ_VAL_FIELD_ORDER_NEXT_FIELD (0x4)</p> <p><i>for Bayer Method 6</i> CORACQ_VAL_FIELD_ORDER_FVAL_LINE2 (0x10)</p>
CORACQ_PRM_HACTIVE	<p><i>mono/color RGB</i> min = 1 pixel max = 16777215 pixel step = 1 pixel</p> <p><i>Bayer</i> min = 1 pixel max = 8192 pixel step = 1 pixel</p>
CORACQ_PRM_HSYNC	min = 2 pixel max = 4294967295 pixel step = 1 pixel
CORACQ_PRM_VACTIVE	min = 1 line max = 16777215 line step = 1 line
CORACQ_PRM_VSYNC	min = 0 line max = 4294967295 line step = 1 line
CORACQ_PRM_HFRONT_INVALID	min = 0 pixel max = 16777215 pixel step = 1 pixel
CORACQ_PRM_HBACK_INVALID	min = 0 pixel max = 16777215 pixel step = 1 pixel
CORACQ_PRM_VFRONT_INVALID	min = 0 line max = 16777215 line step = 1 line
CORACQ_PRM_VBACK_INVALID	min = 0 line max = 16777215 line step = 1 line
CORACQ_PRM_PIXEL_CLK_SRC	CORACQ_VAL_PIXEL_CLK_SRC_EXT (0x2)
CORACQ_PRM_PIXEL_CLK_EXT	min = 20000000 Hz max = 85000000 Hz step = 1 Hz
CORACQ_PRM_SYNC	CORACQ_VAL_SYNC_SEP_SYNC (0x4)

CORACQ_PRM_HSYNC_POLARITY		CORACQ_VAL_ACTIVE_LOW (0x1)
CORACQ_PRM_VSYNC_POLARITY		CORACQ_VAL_ACTIVE_LOW (0x1)
CORACQ_PRM_TIME_INTEGRATE_METHOD		CORACQ_VAL_TIME_INTEGRATE_METHOD_1 (0x1) CORACQ_VAL_TIME_INTEGRATE_METHOD_2 (0x2) CORACQ_VAL_TIME_INTEGRATE_METHOD_3 (0x4) CORACQ_VAL_TIME_INTEGRATE_METHOD_4 (0x8) CORACQ_VAL_TIME_INTEGRATE_METHOD_5 (0x10) CORACQ_VAL_TIME_INTEGRATE_METHOD_6 (0x20) CORACQ_VAL_TIME_INTEGRATE_METHOD_7 (0x40) CORACQ_VAL_TIME_INTEGRATE_METHOD_8 (0x80) CORACQ_VAL_TIME_INTEGRATE_METHOD_9 (0x100)
CORACQ_PRM_CAM_TRIGGER_METHOD		CORACQ_VAL_CAM_TRIGGER_METHOD_1 (0x1) CORACQ_VAL_CAM_TRIGGER_METHOD_2 (0x2)
CORACQ_PRM_CAM_TRIGGER_POLARITY		CORACQ_VAL_ACTIVE_LOW (0x1) CORACQ_VAL_ACTIVE_HIGH (0x2)
CORACQ_PRM_CAM_TRIGGER_DURATION		min = 1 μ s max = 4294967294 μ s step = 1 μ s
CORACQ_PRM_CAM_RESET_METHOD		CORACQ_VAL_CAM_RESET_METHOD_1 (0x1)
CORACQ_PRM_CAM_RESET_POLARITY		CORACQ_VAL_ACTIVE_LOW (0x1) CORACQ_VAL_ACTIVE_HIGH (0x2)
CORACQ_PRM_CAM_RESET_DURATION		min = 1 μ s max = 4294967294 μ s step = 1 μ s
CORACQ_PRM_CAM_NAME	<i>mono</i> <i>color RGB</i> <i>Bayer</i> <i>Bayer Method 6</i> <i>10-taps</i>	Default Area Scan 1 tap Mono Default Area Scan 1 tap Color Default Bayer Area Scan 1 tap Color Default Bayer Line Scan 8 taps parallel Color Default Area Scan 10 taps Parallel Mono
CORACQ_PRM_LINE_INTEGRATE_METHOD		CORACQ_VAL_LINE_INTEGRATE_METHOD_1 (0x1) CORACQ_VAL_LINE_INTEGRATE_METHOD_2 (0x2) CORACQ_VAL_LINE_INTEGRATE_METHOD_3 (0x4) CORACQ_VAL_LINE_INTEGRATE_METHOD_4 (0x8) CORACQ_VAL_LINE_INTEGRATE_METHOD_7 (0x40)
CORACQ_PRM_LINE_TRIGGER_METHOD		CORACQ_VAL_LINE_TRIGGER_METHOD_1 (0x1)
CORACQ_PRM_LINE_TRIGGER_POLARITY		CORACQ_VAL_ACTIVE_LOW (0x1) CORACQ_VAL_ACTIVE_HIGH (0x2)
CORACQ_PRM_LINE_TRIGGER_DELAY		min = 0 μ s max = 65535 μ s step = 1 μ s
CORACQ_PRM_LINE_TRIGGER_DURATION		min = 0 μ s max = 65535 μ s step = 1 μ s
CORACQ_PRM_TAPS	<i>Full mono/Bayer</i> <i>color RGB</i> <i>Base Bayer/Medium RGB</i> <i>Medium Bayer</i> <i>10-taps</i>	min = 1 tap, max = 8 taps, step = 1 tap min = 1 tap, max = 4 taps, step = 1 tap min = 1 tap, max = 3 taps, step = 1 tap min = 1 tap, max = 6 taps, step = 1 tap min = 10 taps, max = 10 taps, step = 1 tap
CORACQ_PRM_TAP_OUTPUT	<i>Medium/Full mono / Bayer</i> <i>color RGB</i> <i>10-taps</i>	CORACQ_VAL_TAP_OUTPUT_ALTERNATE (0x1) CORACQ_VAL_TAP_OUTPUT_SEGMENTED (0x2) CORACQ_VAL_TAP_OUTPUT_PARALLEL (0x4) CORACQ_VAL_TAP_OUTPUT_ALTERNATE (0x1) CORACQ_VAL_TAP_OUTPUT_SEGMENTED (0x2) CORACQ_VAL_TAP_OUTPUT_PARALLEL (0x4)
CORACQ_PRM_TAP_1_DIRECTION		CORACQ_VAL_TAP_DIRECTION_LR (0x1) CORACQ_VAL_TAP_DIRECTION_RL (0x2) CORACQ_VAL_TAP_DIRECTION_UD (0x4) CORACQ_VAL_TAP_DIRECTION_DU (0x8) CORACQ_VAL_TAP_DIRECTION_FROM_TOP (0x10) CORACQ_VAL_TAP_DIRECTION_FROM_MID (0x20) CORACQ_VAL_TAP_DIRECTION_FROM_BOT (0x40)
CORACQ_PRM_TAP_2_DIRECTION		CORACQ_VAL_TAP_DIRECTION_LR (0x1) CORACQ_VAL_TAP_DIRECTION_RL (0x2) CORACQ_VAL_TAP_DIRECTION_UD (0x4) CORACQ_VAL_TAP_DIRECTION_DU (0x8) CORACQ_VAL_TAP_DIRECTION_FROM_TOP (0x10) CORACQ_VAL_TAP_DIRECTION_FROM_MID (0x20) CORACQ_VAL_TAP_DIRECTION_FROM_BOT (0x40)

CORACQ_PRM_TAP_3_DIRECTION		CORACQ_VAL_TAP_DIRECTION_LR (0x1) CORACQ_VAL_TAP_DIRECTION_RL (0x2) CORACQ_VAL_TAP_DIRECTION_UD (0x4) CORACQ_VAL_TAP_DIRECTION_DU (0x8) CORACQ_VAL_TAP_DIRECTION_FROM_TOP (0x10) CORACQ_VAL_TAP_DIRECTION_FROM_MID (0x20) CORACQ_VAL_TAP_DIRECTION_FROM_BOT (0x40)
CORACQ_PRM_TAP_4_DIRECTION	<i>Full mono medium color RGB Full/Medium bayer only</i>	CORACQ_VAL_TAP_DIRECTION_LR (0x1) CORACQ_VAL_TAP_DIRECTION_RL (0x2) CORACQ_VAL_TAP_DIRECTION_UD (0x4) CORACQ_VAL_TAP_DIRECTION_DU (0x8) CORACQ_VAL_TAP_DIRECTION_FROM_TOP (0x10) CORACQ_VAL_TAP_DIRECTION_FROM_MID (0x20) CORACQ_VAL_TAP_DIRECTION_FROM_BOT (0x40)
CORACQ_PRM_TAP_5_DIRECTION	<i>Full mono Full/Medium bayer only</i>	CORACQ_VAL_TAP_DIRECTION_LR (0x1) CORACQ_VAL_TAP_DIRECTION_RL (0x2) CORACQ_VAL_TAP_DIRECTION_UD (0x4) CORACQ_VAL_TAP_DIRECTION_DU (0x8) CORACQ_VAL_TAP_DIRECTION_FROM_TOP (0x10) CORACQ_VAL_TAP_DIRECTION_FROM_MID (0x20) CORACQ_VAL_TAP_DIRECTION_FROM_BOT (0x40)
CORACQ_PRM_TAP_6_DIRECTION	<i>Full mono Full/Medium bayer only</i>	CORACQ_VAL_TAP_DIRECTION_LR (0x1) CORACQ_VAL_TAP_DIRECTION_RL (0x2) CORACQ_VAL_TAP_DIRECTION_UD (0x4) CORACQ_VAL_TAP_DIRECTION_DU (0x8) CORACQ_VAL_TAP_DIRECTION_FROM_TOP (0x10) CORACQ_VAL_TAP_DIRECTION_FROM_MID (0x20) CORACQ_VAL_TAP_DIRECTION_FROM_BOT (0x40)
CORACQ_PRM_TAP_7_DIRECTION	<i>Full mono/bayer only</i>	CORACQ_VAL_TAP_DIRECTION_LR (0x1) CORACQ_VAL_TAP_DIRECTION_RL (0x2) CORACQ_VAL_TAP_DIRECTION_UD (0x4) CORACQ_VAL_TAP_DIRECTION_DU (0x8) CORACQ_VAL_TAP_DIRECTION_FROM_TOP (0x10) CORACQ_VAL_TAP_DIRECTION_FROM_MID (0x20) CORACQ_VAL_TAP_DIRECTION_FROM_BOT (0x40)
CORACQ_PRM_TAP_8_DIRECTION	<i>Full mono/bayer only</i>	CORACQ_VAL_TAP_DIRECTION_LR (0x1) CORACQ_VAL_TAP_DIRECTION_RL (0x2) CORACQ_VAL_TAP_DIRECTION_UD (0x4) CORACQ_VAL_TAP_DIRECTION_DU (0x8) CORACQ_VAL_TAP_DIRECTION_FROM_TOP (0x10) CORACQ_VAL_TAP_DIRECTION_FROM_MID (0x20) CORACQ_VAL_TAP_DIRECTION_FROM_BOT (0x40)
CORACQ_PRM_PIXEL_CLK_DETECTION		CORACQ_VAL_RISING_EDGE (0x4)
CORACQ_PRM_CHANNELS_ORDER		CORACQ_VAL_CHANNELS_ORDER_NORMAL (0x1) CORACQ_VAL_CHANNELS_ORDER_REVERSE (0x2)
CORACQ_PRM_CAM_LINE_TRIGGER_FREQ_MIN		1 Hz
CORACQ_PRM_CAM_LINE_TRIGGER_FREQ_MAX		16777215 Hz
CORACQ_PRM_CAM_TIME_INTEGRATE_DURATION_MIN		1 μ s
CORACQ_PRM_CAM_TIME_INTEGRATE_DURATION_MAX		4294967294 μ s
CORACQ_PRM_TIME_INTEGRATE_PULSE1_POLARITY		CORACQ_VAL_ACTIVE_LOW (0x1) CORACQ_VAL_ACTIVE_HIGH (0x2)
CORACQ_PRM_TIME_INTEGRATE_PULSE1_DELAY		min = 0 μ s max = 4294967294 μ s step = 1 μ s
CORACQ_PRM_TIME_INTEGRATE_PULSE1_DURATION		min = 0 μ s max = 4294967294 μ s step = 1 μ s
CORACQ_PRM_CAM_IO_CONTROL (*)		
CORACQ_PRM_TIME_INTEGRATE_PULSE0_POLARITY		CORACQ_VAL_ACTIVE_LOW (0x1) CORACQ_VAL_ACTIVE_HIGH (0x2)
CORACQ_PRM_TIME_INTEGRATE_PULSE0_DELAY		min = 0 μ s max = 4294967294 μ s step = 1 μ s
CORACQ_PRM_TIME_INTEGRATE_PULSE0_DURATION		min = 1 μ s max = 4294967294 μ s step = 1 μ s
CORACQ_PRM_LINE_INTEGRATE_PULSE1_POLARITY		CORACQ_VAL_ACTIVE_LOW (0x1) CORACQ_VAL_ACTIVE_HIGH (0x2)
CORACQ_PRM_LINE_INTEGRATE_PULSE1_DELAY		min = 0 μ s max = 4294967294 μ s step = 1 μ s

CORACQ_PRM_LINE_INTEGRATE_PULSE1_DURATION		min = 1 μ s max = 4294967294 μ s step = 1 μ s
CORACQ_PRM_LINE_INTEGRATE_PULSE0_POLARITY		CORACQ_VAL_ACTIVE_LOW (0x1) CORACQ_VAL_ACTIVE_HIGH (0x2)
CORACQ_PRM_LINE_INTEGRATE_PULSE0_DELAY		min = 0 μ s max = 65535 μ s step = 1 μ s
CORACQ_PRM_LINE_INTEGRATE_PULSE0_DURATION		min = 1 μ s max = 4294967294 μ s step = 1 μ s
CORACQ_PRM_CAMLINK_CONFIGURATION	<i>Full Mono/Full Bayer</i> <i>Medium Mono</i> <i>medium color RGB/medium Bayer</i> <i>Base Bayer 10-taps</i>	CORACQ_VAL_CAMLINK_CONFIGURATION_BASE (0x1) CORACQ_VAL_CAMLINK_CONFIGURATION_MEDIUM (0x2) CORACQ_VAL_CAMLINK_CONFIGURATION_FULL (0x4) CORACQ_VAL_CAMLINK_CONFIGURATION_BASE (0x1) CORACQ_VAL_CAMLINK_CONFIGURATION_MEDIUM (0x2) CORACQ_VAL_CAMLINK_CONFIGURATION_2BASE (0x8) CORACQ_VAL_CAMLINK_CONFIGURATION_BASE (0x1) CORACQ_VAL_CAMLINK_CONFIGURATION_MEDIUM (0x2) CORACQ_VAL_CAMLINK_CONFIGURATION_BASE (0x1) CORACQ_VAL_CAMLINK_CONFIGURATION_10TAPS_FORMAT2 (0x40)
CORACQ_PRM_DATA_VALID_ENABLE	<i>Mono</i> <i>10 taps</i>	TRUE FALSE Not available
CORACQ_PRM_DATA_VALID_POLARITY		CORACQ_VAL_ACTIVE_HIGH (0x2)
CORACQ_PRM_TAP_9_DIRECTION	<i>10-taps only</i>	CORACQ_VAL_TAP_DIRECTION_LR (0x1) CORACQ_VAL_TAP_DIRECTION_RL (0x2) CORACQ_VAL_TAP_DIRECTION_UD (0x4) CORACQ_VAL_TAP_DIRECTION_DU (0x8) CORACQ_VAL_TAP_DIRECTION_FROM_TOP (0x10) CORACQ_VAL_TAP_DIRECTION_FROM_MID (0x20) CORACQ_VAL_TAP_DIRECTION_FROM_BOT (0x40)
CORACQ_PRM_TAP_10_DIRECTION	<i>10-taps only</i>	CORACQ_VAL_TAP_DIRECTION_LR (0x1) CORACQ_VAL_TAP_DIRECTION_RL (0x2) CORACQ_VAL_TAP_DIRECTION_UD (0x4) CORACQ_VAL_TAP_DIRECTION_DU (0x8) CORACQ_VAL_TAP_DIRECTION_FROM_TOP (0x10) CORACQ_VAL_TAP_DIRECTION_FROM_MID (0x20) CORACQ_VAL_TAP_DIRECTION_FROM_BOT (0x40)
CORACQ_PRM_TIMESLOT	<i>10-taps</i> <i>Others</i>	CORACQ_VAL_TIMESLOT_1 (0x1) CORACQ_VAL_TIMESLOT_1 (0x1) CORACQ_VAL_TIMESLOT_2 (0x2)
CORACQ_PRM_BAYER_ALIGNMENT	<i>mono, color RGB</i> <i>Bayer</i> <i>Bayer Method 6</i>	Not available CORACQ_VAL_BAYER_ALIGNMENT_GB_RG (0x1) CORACQ_VAL_BAYER_ALIGNMENT_BG_GR (0x2) CORACQ_VAL_BAYER_ALIGNMENT_RG_GB (0x4) CORACQ_VAL_BAYER_ALIGNMENT_GR_BG (0x8) CORACQ_VAL_BAYER_ALIGNMENT_GB_RG (0x1) CORACQ_VAL_BAYER_ALIGNMENT_RG_GB (0x4)
CORACQ_PRM_CAM_CONTROL_DURING_READOUT		TRUE FALSE

Table 2: Camera Related Parameters

VIC Related Parameters

Parameter	Values
CORACQ_PRM_CAMSEL	<i>Mono/Bayer</i> CAMSEL_MONO = from 0 to 0 <i>color RGB</i> CAMSEL_RGB = from 0 to 0
CORACQ_PRM_CROP_LEFT	min = 0 pixel max = 16777215 pixel step = 16 pixel

CORACQ_PRM_CROP_TOP		min = 0 line max = 16777215 line step = 1 line step = 2 lines (Bayer)
CORACQ_PRM_CROP_WIDTH		min = 16 pixel max = 16777215 pixel step = 16 pixel step = 2 (color RGB)
CORACQ_PRM_CROP_HEIGHT		min = 1 line max = 16777215 line step = 1 line
CORACQ_PRM_DECIMATE_METHOD		CORACQ_VAL_DECIMATE_DISABLE (0x1)
CORACQ_PRM_LUT_ENABLE		TRUE FALSE
CORACQ_PRM_LUT_NUMBER		Default = 0
CORACQ_PRM_STROBE_ENABLE		TRUE FALSE
CORACQ_PRM_STROBE_METHOD		CORACQ_VAL_STROBE_METHOD_1 (0x1) CORACQ_VAL_STROBE_METHOD_2 (0x2) CORACQ_VAL_STROBE_METHOD_3 (0x4) CORACQ_VAL_STROBE_METHOD_4 (0x8)
CORACQ_PRM_STROBE_POLARITY		CORACQ_VAL_ACTIVE_LOW (0x1) CORACQ_VAL_ACTIVE_HIGH (0x2)
CORACQ_PRM_STROBE_DURATION		min = 0 μ s max = 4294967294 μ s step = 1 μ s
CORACQ_PRM_STROBE_DELAY		min = 0 μ s max = 4294967294 μ s step = 1 μ s
CORACQ_PRM_TIME_INTEGRATE_ENABLE		TRUE FALSE
CORACQ_PRM_TIME_INTEGRATE_DURATION		min = 1 μ s max = 4294967294 μ s step = 1 μ s
CORACQ_PRM_CAM_TRIGGER_ENABLE		TRUE FALSE
CORACQ_PRM_CAM_RESET_ENABLE		TRUE FALSE
CORACQ_PRM_OUTPUT_FORMAT	<i>mono</i> <i>color RGB</i> <i>Bayer</i>	CORACQ_VAL_OUTPUT_FORMAT_MONO8 CORACQ_VAL_OUTPUT_FORMAT_MONO16 CORACQ_VAL_OUTPUT_FORMAT_RGB8888 CORACQ_VAL_OUTPUT_FORMAT_RGB101010 CORACQ_VAL_OUTPUT_FORMAT_RGB16161616 CORACQ_VAL_OUTPUT_FORMAT_RGB8888 CORACQ_VAL_OUTPUT_FORMAT_RGB101010 CORACQ_VAL_OUTPUT_FORMAT_MONO8 CORACQ_VAL_OUTPUT_FORMAT_MONO16
CORACQ_PRM_EXT_TRIGGER_ENABLE		CORACQ_VAL_EXT_TRIGGER_OFF (0x1) CORACQ_VAL_EXT_TRIGGER_ON (0x8)
CORACQ_PRM_VIC_NAME	<i>Mono</i> <i>Color RGB</i> <i>Bayer</i> <i>Bayer Method 6</i> <i>10-taps</i>	Default Area Scan 1 tap Mono Default Area Scan 1 tap Color Default Bayer Area Scan 1 tap Color Default Bayer Line Scan 8 taps Parallel Color Default Area Scan 10 taps Parallel Mono
CORACQ_PRM_LUT_MAX		1
CORACQ_PRM_EXT_TRIGGER_DETECTION		CORACQ_VAL_ACTIVE_LOW (0x1) CORACQ_VAL_ACTIVE_HIGH (0x2) CORACQ_VAL_RISING_EDGE (0x4) CORACQ_VAL_FALLING_EDGE (0x8)
CORACQ_PRM_LUT_FORMAT	<i>mono</i> <i>color RGB</i> <i>bayer</i>	Default = CORACQ_VAL_OUTPUT_FORMAT_MONO8 Default = CORACQ_VAL_OUTPUT_FORMAT_RGB16161616 Default = CORACQ_VAL_OUTPUT_FORMAT_MONO16
CORACQ_PRM_VSYNC_REF		CORACQ_VAL_SYNC_REF_END (0x2)
CORACQ_PRM_HSYNC_REF		CORACQ_VAL_SYNC_REF_END (0x2)
CORACQ_PRM_LINE_INTEGRATE_ENABLE		TRUE FALSE

CORACQ_PRM_LINE_INTEGRATE_DURATION		min = 1 pixel max = 16777215 pixel step = 1 pixel
CORACQ_PRM_LINE_TRIGGER_ENABLE		TRUE FALSE
CORACQ_PRM_EXT_FRAME_TRIGGER_ENABLE		TRUE FALSE
CORACQ_PRM_EXT_FRAME_TRIGGER_DETECTION		CORACQ_VAL_ACTIVE_LOW (0x1) CORACQ_VAL_ACTIVE_HIGH (0x2) CORACQ_VAL_RISING_EDGE (0x4) CORACQ_VAL_FALLING_EDGE (0x8) CORACQ_VAL_DOUBLE_PULSE_RISING_EDGE (0x20) CORACQ_VAL_DOUBLE_PULSE_FALLING_EDGE (0x40)
CORACQ_PRM_EXT_LINE_TRIGGER_ENABLE		TRUE FALSE
CORACQ_PRM_EXT_LINE_TRIGGER_DETECTION		CORACQ_VAL_RISING_EDGE (0x4)
CORACQ_PRM_SNAP_COUNT		min = 1 frame max = 65535 frame step = 1 frame
CORACQ_PRM_INT_LINE_TRIGGER_ENABLE		TRUE FALSE
CORACQ_PRM_INT_LINE_TRIGGER_FREQ		Default = 5000 Hz
CORACQ_PRM_BIT_ORDERING		CORACQ_VAL_BIT_ORDERING_STD (0x1)
CORACQ_PRM_EXT_TRIGGER_LEVEL		CORACQ_VAL_LEVEL_TTL (0x1) CORACQ_VAL_LEVEL_422 (0x2)
CORACQ_PRM_STROBE_LEVEL		CORACQ_VAL_LEVEL_TTL (0x1)
CORACQ_PRM_EXT_FRAME_TRIGGER_LEVEL		CORACQ_VAL_LEVEL_TTL (0x1) CORACQ_VAL_LEVEL_422 (0x2)
CORACQ_PRM_EXT_LINE_TRIGGER_LEVEL		CORACQ_VAL_LEVEL_422 (0x2)
CORACQ_PRM_INT_LINE_TRIGGER_FREQ_MIN		245 Hz
CORACQ_PRM_INT_LINE_TRIGGER_FREQ_MAX		500000 Hz
CORACQ_PRM_MASTER_MODE		Not available
CORACQ_PRM_SHAFT_ENCODER_DROP		min = 0 tick max = 255 tick step = 1 tick
CORACQ_PRM_SHAFT_ENCODER_ENABLE		TRUE FALSE
CORACQ_PRM_EXT_TRIGGER_FRAME_COUNT		min = 1 frame max = 65534 frame step = 1 frame
CORACQ_PRM_INT_FRAME_TRIGGER_ENABLE		TRUE FALSE
CORACQ_PRM_INT_FRAME_TRIGGER_FREQ		min = 1 milli-Hz max = 1073741823 milli-Hz step = 1 milli-Hz
CORACQ_PRM_STROBE_DELAY_2		min = 0 μ s max = 4294967294 μ s step = 1 μ s
CORACQ_PRM_FRAME_LENGTH		CORACQ_VAL_FRAME_LENGTH_FIX (0x1) CORACQ_VAL_FRAME_LENGTH_VARIABLE (0x2)
CORACQ_PRM_FLIP	<i>mono</i> <i>10 taps/Bayer</i>	CORACQ_VAL_FLIP_OFF (0x00) CORACQ_VAL_FLIP_HORZ (0x01) Not Available
CORACQ_PRM_EXT_TRIGGER_DURATION		min = 0 μ s max = 255 μ s step = 1 μ s
CORACQ_PRM_TIME_INTEGRATE_DELAY		min = 0 μ s max = 4294967294 μ s step = 1 μ s
CORACQ_PRM_CAM_RESET_DELAY		min = 0 μ s max = 0 μ s step = 1 μ s
CORACQ_PRM_CAM_TRIGGER_DELAY		min = 0 μ s max = 4294967294 μ s step = 1 μ s
CORACQ_PRM_SHAFT_ENCODER_LEVEL		CORACQ_VAL_LEVEL_422 (0x2)

CORACQ_PRM_EXT_FRAME_TRIGGER_SOURCE (*)		min = 0 max = 6 step = 1
CORACQ_PRM_EXT_LINE_TRIGGER_SOURCE (*)		min = 0 max = 7 step = 1
CORACQ_PRM_EXT_TRIGGER_SOURCE (*)		min = 0 max = 6 step = 1
CORACQ_PRM_SHAFT_ENCODER_MULTIPLY		min = 1 max = 32 step = (2**N)
CORACQ_PRM_PLANAR_INPUT_SOURCES		Not available
CORACQ_PRM_EXT_TRIGGER_DELAY		min = 0 max = 4294967294 step = 1
CORACQ_PRM_EXT_TRIGGER_DELAY_TIME_BASE		CORACQ_VAL_TIME_BASE_US (0x1) CORACQ_VAL_TIME_BASE_LINE (0x4) CORACQ_VAL_TIME_BASE_LINE_TRIGGER (0x8)
CORACQ_PRM_BAYER_DECODER_ENABLE	<i>Full</i> <i>Bayer</i>	Not available (mono or color RGB) TRUE / FALSE
CORACQ_PRM_BAYER_DECODER_METHOD	<i>Full</i> <i>Bayer</i> <i>Bayer Method 6</i>	Not available (mono or color RGB) CORACQ_VAL_BAYER_DECODER_METHOD_1 (0x1) CORACQ_VAL_BAYER_DECODER_METHOD_6 (0x20)
CORACQ_PRM_BAYER_DECODER_WB_GAIN	<i>Full</i> <i>Bayer</i>	Not available (mono or color RGB) min = 100000 max = 899609 step = 1
CORACQ_PRM_BAYER_DECODER_WB_GAIN_RED	<i>Full</i> <i>Bayer</i>	Not available (mono or color RGB) min = 100000 max = 499609 step = 1
CORACQ_PRM_BAYER_DECODER_WB_GAIN_GREEN	<i>Full</i> <i>Bayer</i>	Not available (mono or color RGB) min = 100000 max = 499609 step = 1
CORACQ_PRM_BAYER_DECODER_WB_GAIN_BLUE	<i>Full</i> <i>Bayer</i>	Not available (mono or color RGB) min = 100000 max = 899609 step = 1
CORACQ_PRM_EXT_TRIGGER_IGNORE_DELAY		min = 0 max = 65535000 step = 1
CORACQ_PRM_EXT_TRIGGER_SOURCE_STR		[0] = Automatic [1] = From External Trigger #1 [2] = From External Trigger #2 [3] = From Board Sync [4] = To Board Sync [5] = Pulse to Board Sync [6] = Software Trigger
CORACQ_PRM_EXT_LINE_TRIGGER_SOURCE_STR		[0] = Automatic [1] = From Shaft Encoder Phase A [2] = From Shaft Encoder Phase B [3] = From Shaft Encoder Phase A & B [4] = From Board Sync [5] = To Board Sync [6] = Pulse to Board Sync [7] = To Board Sync When Grabbing
CORACQ_PRM_VERTICAL_TIMEOUT_DELAY		min = 0 max = 16383000 step = 1
CORACQ_PRM_BAYER_DECODER_SATURATION_FACTOR	<i>Bayer</i>	min = 0 max = 65535 step = 1
CORACQ_PRM_BAYER_DECODER_SATURATION_WEIGHT_RED	<i>Bayer</i>	min = 0 max = 65535 step = 1
CORACQ_PRM_BAYER_DECODER_SATURATION_WEIGHT_GREEN	<i>Bayer</i>	min = 0 max = 65535 step = 1

CORACQ_PRM_BAYER_DECODER_SATURATION_WEIGHT_BLUE	<i>Bayer</i>	min = 0 max = 65535 step = 1
CORACQ_PRM_POCL_ENABLE		TRUE FALSE
CORACQ_PRM_SHAFT_ENCODER_SOURCE (*)		Not available
CORACQ_PRM_SHAFT_ENCODER_SOURCE_STR		Not available
CORACQ_PRM_SHAFT_ENCODER_DIRECTION		CORACQ_VAL_SHAFT_ENCODER_DIRECTION_IGNORE (0x00) CORACQ_VAL_SHAFT_ENCODER_DIRECTION_FORWARD (0x01) CORACQ_VAL_SHAFT_ENCODER_DIRECTION_REVERSE (0x02)
CORACQ_PRM_LINE_TRIGGER_AUTO_DELAY		CORACQ_VAL_LINE_TRIGGER_AUTO_DELAY_DISABLE CORACQ_VAL_LINE_TRIGGER_AUTO_DELAY_FREQ_MAX

Table 3: VIC Related Parameters

ACQ Related Parameters

Parameter	Values
CORACQ_PRM_LABEL	<i>Full mono</i> CameraLink Full Mono #1 <i>Medium mono</i> CameraLink Medium Mono #1 <i>color RGB</i> CameraLink Medium Color RGB #1 <i>Full/Medium Bayer</i> CameraLink Bayer #1 <i>10 taps</i> CameraLink 10 Taps Parallel Mono #1 <i>Dual mono</i> CameraLink Base Mono #1 CameraLink Base Mono #2 <i>Dual Bayer</i> CameraLink Bayer #1 CameraLink Bayer #2
CORACQ_PRM_EVENT_TYPE	CORACQ_VAL_EVENT_TYPE_START_OF_FRAME CORACQ_VAL_EVENT_TYPE_END_OF_FRAME CORACQ_VAL_EVENT_TYPE_EXTERNAL_TRIGGER CORACQ_VAL_EVENT_TYPE_VERTICAL_SYNC CORACQ_VAL_EVENT_TYPE_NO_PIXEL_CLK CORACQ_VAL_EVENT_TYPE_PIXEL_CLK CORACQ_VAL_EVENT_TYPE_FRAME_LOST CORACQ_VAL_EVENT_TYPE_DATA_OVERFLOW CORACQ_VAL_EVENT_TYPE_EXTERNAL_TRIGGER_IGNORED CORACQ_VAL_EVENT_TYPE_VERTICAL_TIMEOUT CORACQ_VAL_EVENT_TYPE_EXT_LINE_TRIGGER_TOO_SLOW CORACQ_VAL_EVENT_TYPE_LINE_TRIGGER_TOO_FAST CORACQ_VAL_EVENT_TYPE_SHAFT_ENCODER_REVERSE_COUNT_OVERFLOW
CORACQ_PRM_SIGNAL_STATUS	CORACQ_VAL_SIGNAL_HSYNC_PRESENT CORACQ_VAL_SIGNAL_VSYNC_PRESENT CORACQ_VAL_SIGNAL_PIXEL_CLK_1_PRESENT CORACQ_VAL_SIGNAL_PIXEL_CLK_2_PRESENT CORACQ_VAL_SIGNAL_PIXEL_CLK_3_PRESENT CORACQ_VAL_SIGNAL_PIXEL_CLK_ALL_PRESENT CORACQ_VAL_SIGNAL_POWER_PRESENT CORACQ_VAL_SIGNAL_POCL_ACTIVE
CORACQ_PRM_FLAT_FIELD_SELECT	0
CORACQ_PRM_FLAT_FIELD_ENABLE	<i>Medium/Full Mono/10 taps</i> TRUE FALSE <i>color RGB/Bayer</i> Not Available
CORACQ_CAP_FLAT_FIELD_OFFSET	min = 0 max = 255 step = 1
CORACQ_CAP_FLAT_FIELD_GAIN	min = 1 max = 255 step = 1
CORACQ_CAP_FLAT_FIELD_GAIN_DIVISOR	0x80
CORACQ_CAP_FLAT_FIELD_PIXEL_REPLACEMENT	TRUE: *Pixel replacement is usually done by averaging the 2 neighborhood pixels. When one of the neighbors is not available (border image pixels, and border internal packet pixels), the pixel is simply replaced with the available neighbor.
CORACQ_CAP_SERIAL_PORT_INDEX	Supported

Windows Embedded 7 Installation

Windows Embedded 7 is not officially supported by Teledyne DALSA due to the number of possible configurations. However, Sapera LT and other Teledyne DALSA products should function properly on the Windows Embedded 7 platform provided that the required components are installed.

Teledyne DALSA provides answer files (.xml) for use during Windows Embedded 7 installation that install all necessary components for running Sapera LT 32-bit or 64-bit versions (SDK or Runtime), Sapera Processing 32-bit or 64-bit versions (SDK or Runtime), and Teledyne DALSA framegrabbers.

For each platform (32 or 64-bit), the answer file provided is:

- **SaperaFrameGrabbers.xml:**
Configuration for Sapera LT, Sapera Processing and Teledyne DALSA framegrabbers

The file is located in the following directory dependent on the platform used:

```
<Install Directory>\Sapera\Install\Win7_Embedded\Win32  
<Install Directory>\Sapera\Install\Win7_Embedded\Win64
```

The OS footprint for these configurations is less than 1 GB. Alternatively, the Windows Thin Client configuration template provided by Microsoft in the Windows Embedded 7 installation also provides the necessary dependencies for Sapera LT, and Teledyne DALSA framegrabbers (with an OS footprint of approximately 1.5 GB).

If you are installing other applications on the Windows Embedded 7 platform, it is recommended that you verify which components are required, and if necessary, create a corresponding "Answer File".

For more information on performing dependency analysis to enable your application on Windows Embedded 7, refer to the Microsoft Windows Embedded 7 documentation.

Sapera Servers & Resources

Servers and Resources

The following table describes the X64 Xcelera-CL PX4 Full board

Servers		Resources		
Name	Type	Name	Index	Description
Xcelera-CL_PX4_1 (default firmware with FFC)	Acquisition	CameraLink Full Mono	0	Full configuration, monochrome output, Camera #1
		CameraLink Medium Color RGB #1	1	Medium configuration, RGB output, Camera #1
Xcelera-CL_PX4_1 (10 tap firmware)	Acquisition	CameraLink 10 Tap Parallel Mono #1	0	Full configuration, 10 Tap Format 2, Camera #1
Xcelera-CL_PX4_1 (Bayer firmware)	Acquisition	CameraLink Bayer #1	0	Base, Medium or Full configuration, Bayer Decoder, Camera #1

The following table describes the X64 Xcelera-CL PX4 Dual board

Servers		Resources		
Name	Type	Name	Index	Description
Xcelera-CL_PX4_1 (default Base firmware with FFC)	Acquisition	CameraLink Base Mono 1	0	Base configuration, monochrome Camera #1
		CameraLink Base Mono 2	1	Base configuration, monochrome Camera #2
		CameraLink Base RGB 1	2	Base configuration, color RGB Camera #1
		CameraLink Base RGB 2	3	Base configuration, color RGB Camera #2
Xcelera-CL_PX4_1 (Medium firmware with FFC)	Acquisition	CameraLink Medium Monochrome 1	0	Medium configuration, monochrome Camera #1
		CameraLink Medium Color RGB 1	1	Medium configuration, RGB Camera #1
Xcelera-CL_PX4_1 (Bayer Base firmware)	Acquisition	CameraLink Base Bayer 1	0	Base or Medium configuration, Bayer Decoder, Camera #1
		CameraLink Base Bayer 2	1	Base configuration, Bayer Decoder, Camera #2
Xcelera-CL_PX4_1 (Bayer Medium firmware)	Acquisition	CameraLink Medium Bayer #1	0	Base or Medium configuration, Bayer Decoder, Camera #1

Technical Specifications

X64 Xcelera-CL PX4 Board Specifications

Digital Video Input & Controls

Input Type	Camera Link Specifications Rev 1.2 compliant; 1 Full or 1 Medium or 2 Base Supports PoCL cameras
Common Pixel Formats	CameraLink tap configuration for 8, 10, 12, 14 and 16-bit mono, 24-bit RGB and Bayer, 30-bit RGB, 36-bit RGB.
Tap Format Details	1 Tap – 8/10/12/14/16-bit mono 2 Taps – 8/10/12/14/16-bit mono 3 Taps – 8-bit mono 4 Taps – 8/10/12-bit mono 4 Taps – 14/16-bit mono (non-standard) 8 taps – 8-bit mono 10 taps – 8-bit mono (non-standard) 3 taps – 8/10/12-bit RGB
Scanning	Area scan and Line scan: Progressive, Multi-Tap, Multi-Channel, Tap reversal, Segmented Tap Configuration, Alternate Tap Configuration
Scanning Directions	Left to Right, Right to Left, Up-Down, Down-Up From Top, From Middle, From Bottom
Resolution <i>note: these are X64 Xcelera-CL PX4 maximums, not Camera Link specifications</i>	Horizontal Minimum: 8 Pixels per tap (8-bits/pixel) Horizontal Maximum: 8-bits/pixel x 256K Pixels/line 16-bits/pixel x 128K Pixels/line 32-bits/pixel x 64K Pixels/line 64-bits/pixel x 32K Pixels/line Vertical Minimum: 1 line Vertical Maximum: up to 16,000,000 lines—for area scan sensors infinite line count—for linescan sensors
Pixel Clock Range	20 MHz to 85 MHz as follows: 8-bit: 8 taps @ 85 MHz, any tap configuration 10/12/14/16-bit: 4 taps @ 85 MHz, any tap configuration
Synchronization Minimums	Horizontal Sync minimum: 1 pixel Vertical Sync minimum: 1 line
Image Buffer	Available with 128 MB
Bandwidth to Host System	Approximately 750MB/s without frame lost.
Serial Port	Supports communication speeds from 9600 to 921600 bps

<p>Controls</p>	<p>Compliant with Teledyne DALSA Trigger-to-Image Reliability framework</p> <p>Comprehensive event notifications (see "Trigger to Image Reliability" on page 43)</p> <p>Timing control logic for EXSYNC, PRIN and strobe signals</p> <p>Dual independent opto-coupled external trigger inputs programmable as active high or low (edge or level trigger, where pulse width minimum is 100ns)</p> <p>External trigger latency less than 1 μsec.</p> <p>Supports multi-board / multi-camera synchronization</p> <p>Dual independent TTL Strobe outputs</p> <p>Quadrature (phase A &B) shaft-encoder inputs for external web synchronization (opto-coupler maximum frequency for any shaft encoder input is 200 KHz)</p> <p>4 opto-coupled general inputs (5V/24V)</p> <p>4 opto-coupled general outputs</p>
<p>Processing</p> <p><i>Dependant on user loaded firmware configuration</i></p>	<p>Output Lookup Table</p> <p>one 8-bit in – 8-bit out</p> <p>one 10-bit in – 10-bit out</p> <p>one 12-bit in – 12-bit out</p> <p>three 8-bit in – 8-bit out (RGB)</p> <p>See section "Output LUT Availability" (page 46) for details.</p> <p>Bayer Mosaic Filter:</p> <p>Hardware Bayer Engine supports one 8, 10 or 12-bit Bayer camera input.</p> <p>Bayer output format supports 8 or 10-bit RGB/pixel.</p> <p>Zero host CPU utilization for Bayer conversion.</p> <p>Flat Field Correction (Shading Correction):</p> <p>Real-time Flat-line and Flat-field correction.</p> <p>Compensates for sensor defects such as FPN, PRNU, defective pixels and variations between pixels due to the light refraction through a lens (Shading effect).</p> <p>PRNU (<i>Photo Response Non Uniformity</i>): PRNU is the variation in response between sensor pixels.</p> <p>FPN (<i>Fixed Pattern Noise</i>): FPN is the unwanted static variations in response for all pixels in the image.</p>

Host System Requirements

X64 Xcelera-CL PX4 Dimensions

Approximately 6.5 in. (16.6 cm) wide by 4 in. (10 cm) high.

General System Requirements for the X64 Xcelera-CL PX4

- PCI Express x4 slot or x8 slot compatible
- On some computers the X64 Xcelera-CL PX4 may function installed in a x16 slot. The computer documentation or direct testing is required.
- X64 Xcelera-CL PX4 operates correctly when installed in a multi-processor system (including Hyper-Threading multi-core processors).

Operating System Support

Windows XP, Windows Vista, Windows 7 and Windows 8, either 32-bit or 64-bit

Environment

Ambient Temperature:	10° to 50° C (operation) -40° to 75° C (storage)
Relative Humidity:	5% to 90% non-condensing (operating) 0% to 95% (storage)



Note: Ensure adequate airflow for proper functioning of the board across the entire temperature range of 10 – 50°C . We recommend airflow measuring 200 LFM (linear feet per minute) across the surface of the board when operating above 40°C.

Power Requirements

+3.3V:	1.92A (standby) 2.64A (during acquisition)
+12V:	0.72A (standby) 0.81A (during acquisition)



EC & FCC DECLARATION OF CONFORMITY

We : Teledyne DALSA inc.
 7075 Place Robert-Joncas, Suite 142,
 St. Laurent, Quebec, Canada, H4M 2Z2

Declare under sole legal responsibility that the following products conform to the protection requirements of council directive 2004/108/EC on the approximation of the laws of member states relating to electromagnetic compatibility:

Xcelera-CL PX4

The products to which this declaration relates are in conformity with the following relevant harmonized standards, the reference numbers of which have been published in the Official Journal of the European Communities:

The products to which this declaration relates are in conformity with the following relevant harmonized standards, the reference numbers of which have been published in the Official Journal of the European Communities:

EN55022:2006, A1:2007
EN55024:1998, A1:2001, A2:2003
ENV50204:1995

Further declare under our sole legal responsibility that the product listed conforms to the code of federal regulations CFR 47 part 15 (2008), subpart B, for a class A product.

St. Laurent, Canada 2012-04-09
Location Date

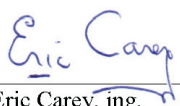
Eric Carey, ing.
Director,
Research and Development

Connector and Switch Locations

X64 Xcelera-CL PX4 Board Layout Drawing

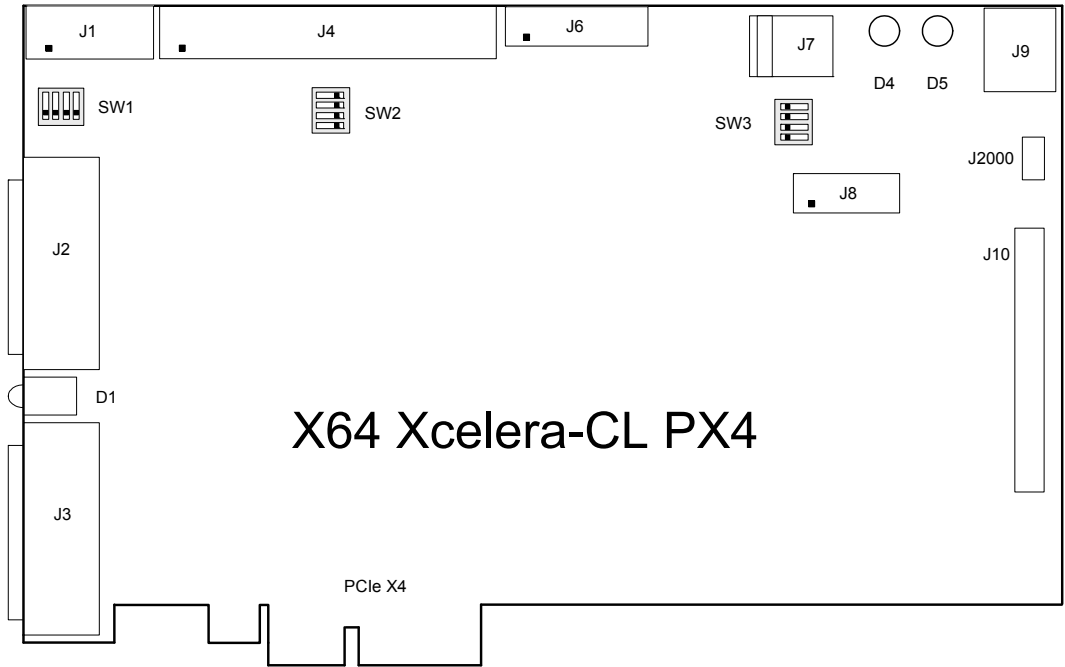

Connector, Switch, Jumper Description List

The following table lists components on the X64 Xcelera-CL PX4 board. Detailed information follows for connectors or switches the end user may have need of.

Location	Description	Location	Description
J2	Camera Link Connector	J6	X-I/O Module Interface
J3	Camera Link Connector	J7	PC DC power to external signals connector and to camera interface for PoCL usage.
J4	External Signals connector	J1, J8, J10, J2000	Reserved
J9	Multi Board Sync	SW1, SW2, SW3	Configuration micro-switches
D1	Camera/PCIe status LEDs	D4, D5	Boot-up Status LEDs (refer to text)

Connector and Switch Specifications

X64 Xcelera-CL PX4 End Bracket Detail

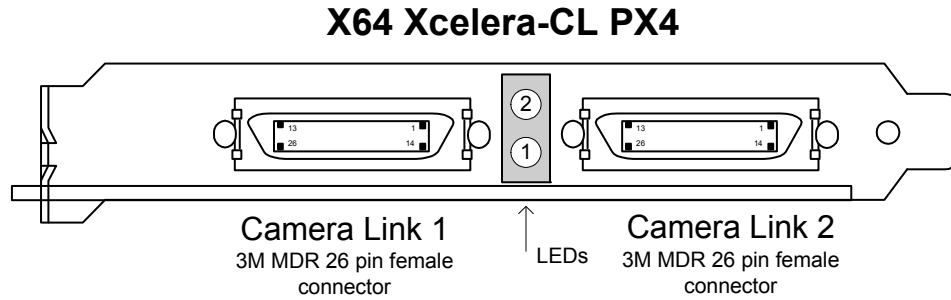

The hardware installation process is completed with the connection of a supported camera to the X64 Xcelera-CL PX4 board using Camera Link cables (see "Camera Link Cables" on page 79).

- The X64 Xcelera-CL PX4 board supports a camera with one or two Camera Link MDR-26 connectors (two Base or one Medium – see "Data Port Summary" on page 78 for information on Camera Link configurations).
- Connect the camera to the J1 connector with a Camera Link cable. When using a Medium camera, connect the second camera connector to J2.



Note: If the camera is powered by the X64 Xcelera-CL PX4, refer to "External Signals Connector Bracket Assembly" on page 74 for power connections.

Contact Teledyne DALSA or browse our web site <http://www.teledynedalsa.com/imaging/support/> for the latest information on X64 Xcelera-CL PX4 supported cameras.

Configuration Micro-switches

Three sets of 4 switches are used for user configurations not controlled by software. The following figure is a typical view of each switch set, shown with the individual switch set in the OFF position. Following the figure, each of the three switch sets is described. Refer to the board component layout for their positions.

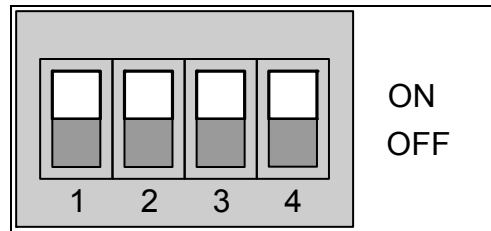

SW1, SW2, SW3 Component View

SW1: General Inputs Signal Switch Point

For each general input, select the threshold voltage detected as a logic high signal. See "Note 1: General Inputs Specifications" on page 69.

SW1 Switch Number	Assigned to	OFF Position	ON Position (default)
1	general input 1	Logic Transition at ~2 volts	Logic Transition at ~10 volts
2	general input 2	(preferred for differential signals)	
3	general input 3		
4	general input 4		

SW2: Trigger Inputs Signal Switch Point

For each trigger input, select the threshold voltage detected as a logic high signal. See "Note 3: External Trigger Input Specifications" on page 71.

SW2 Switch Number	Assigned to	OFF Position (default)	ON Position
1	trigger input 1	Logic Transition at ~2 volts	Logic Transition at ~10 volts
2	trigger input 2	(preferred for differential signals)	
3	NA		
4	NA		

SW3: Normal/Safe Boot Mode & GEN2 Slot Workaround

The X64 Xcelera-CL PX4 powers up either in its normal state or a 'Safe Boot' mode required to load firmware under certain conditions. See the notes for SW3-1 following the table for details.

SW3 Switch Number	Assigned to	OFF Position (default)	ON Position
1	Boot Mode	Normal	Safe
2	GEN2 Slot Workaround	Disable (default)	Active
3	reserved		
4	reserved		

SW3-1 Boot Mode Details

- **Normal Mode:** Board powers up in the normal operating mode.
- **Safe Mode:** With the computer off, move the switch to the ON position. This mode is required if any problems occurred while updating firmware. With the switch in the ON position, power on the computer and update the firmware again. When the update is complete, power off the computer and move the switch to the OFF position. Power on the computer once again for normal operation. (See "Recovering from a Firmware Update Error" on page 23).

SW3-2 GEN2 Slot Workaround Details

- **Normal Mode:** Normal operation of the Xcelera-CL PX4.
- **GEN2 Slot Workaround:** In computers with GEN2 slots and the Intel 5400 chipset, there have been circumstances where the board is not detected properly. This issue is identified by the status LED 2 that keeps on flashing red at boot time. In one example, with a Dell T5400 or T7400 computer, the following message was displayed by the computer BIOS: "Alert! Error initializing PCI Express slot".

- Therefore when using such a computer, with the Xcelera SW3-2 in the ON position, the computer should boot normally and the Xcelera should function. If this is not the case, please contact "Technical Support" on page 91 with details about your computer.
- Note: ECO 4251 is needed for SW3-2 to be functional.

Status LEDs Functional Description

D4 Boot-up status LED

Note: The LED D4 is mounted near the top edge of the board and is visible only with the computer cover off.

Color	State	Description
Green	Solid	Safe FPGA firmware loaded
Off	-	Normal FPGA firmware loaded

Table 4: D4 Boot-up Status LED

D5 Boot-up status LED

Note: The LED D5 is mounted near the top edge of the board and is visible only with the computer cover off.

Color	State	Description
Green	Solid	FPGA firmware loaded successfully
Off	-	FPGA firmware not loaded

Table 5: D5 Boot-up Status LED

Camera & PCIe status LED

Status LEDs are mounted between the camera link connectors—visible from the computer exterior.

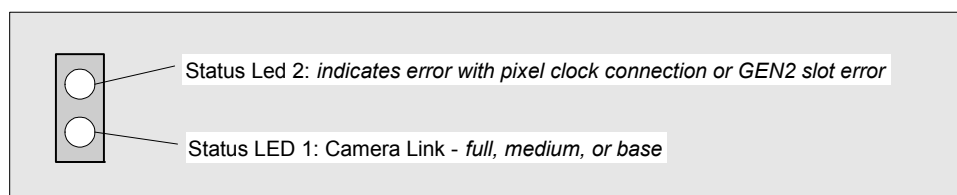

D1 - LED 1 Status

Color	State	Description
Red	Solid	No Camera #1 pixel clock detected
Green	Solid	Camera #1 pixel clock detected. No line valid detected.
Green	Slow Flashing ~2 Hz	Camera #1 pixel clock and line valid signal detected
Green	Fast Flashing ~16 Hz	Camera #1 acquisition in progress

Table 6: LED 1 Status

D1 - LED 2 Status

Color	State	Description
Red	Solid	No Camera #2 pixel clock detected
Green	Solid	Camera #2 pixel clock detected. No line valid detected.
Green	Slow Flashing ~2 Hz	Camera #2 pixel clock and line valid signal detected
Green	Fast Flashing ~16 Hz	Camera #2 acquisition in progress
Red	Flashing	PCIe Training Issue – Board is not be detected by computer. Camera pixel clock incorrectly connected to J3 instead of J2 (Medium/Full configuration)

Table 7: LED 2 Status

J2: Camera Link Connector 1

Name	Pin #	Type	Description
BASE_X0-	25	Input	Neg. Base Data 0
BASE_X0+	12	Input	Pos. Base Data 0
BASE_X1-	24	Input	Neg. Base Data 1
BASE_X1+	11	Input	Pos. Base Data 1
BASE_X2-	23	Input	Neg. Base Data 2
BASE_X2+	10	Input	Pos. Base Data 2
BASE_X3-	21	Input	Neg. Base Data 3
BASE_X3+	8	Input	Pos. Base Data 3
BASE_XCLK-	22	Input	Neg. Base Clock
BASE_XCLK+	9	Input	Pos. Base Clock
SERTC+	20	Output	Pos. Serial Data to Camera
SERTC-	7	Output	Neg. Serial Data to Camera
SERTFG-	19	Input	Neg. Serial Data to Frame Grabber
SERTFG+	6	Input	Pos. Serial Data to Frame Grabber
CC1-	18	Output	Neg. Camera Control 1
CC1+	5	Output	Pos. Camera Control 1
CC2+	17	Output	Pos. Camera Control 2
CC2-	4	Output	Neg. Camera Control 2
CC3-	16	Output	Neg. Camera Control 3
CC3+	3	Output	Pos. Camera Control 3
CC4+	15	Output	Pos. Camera Control 4
CC4-	2	Output	Neg. Camera Control 4
PoCL	1,26		+12 V (see note following this table)
GND	13, 14		Ground

Notes on PoCL support:

- Refer to Sopera's parameter CORACQ_PRM_POCL_ENABLE to enable PoCL and CORACQ_PRM_SIGNAL_STATUS/CORACQ_VAL_SIGNAL_POCL_ACTIVE to verify if the POCL is active. See also Sopera++ reference parameter SapAcquisition::SignalPoCLActive for the current state.
- For board driver 1.30 or later, the PoCL state is maintained after a board reset.
- For driver 1.10 or 1.20, PoCL is disabled after every board reset.
- Minimum board ECO levels – Full (#1387-1), Dual (#1420).
- PoCL state is maintained after a board reset
- Requires a PC Floppy drive power connector inserted onto J7 for PoCL cameras

J3: Camera Link Connector 2

For X64 Xcelera-CL PX4, Medium and Full Camera Link sources require cables connected to both J2 and J3.

For X64 Xcelera-CL PX4 Dual boards, J3 pinout is identical to J2.

Name	Pin #	Type	Description
MEDIUM_X0-	25	Input	Neg. Medium Data 0
MEDIUM_X0+	12	Input	Pos. Medium Data 0
MEDIUM_X1-	24	Input	Neg. Medium Data 1
MEDIUM_X1+	11	Input	Pos. Medium Data 1
MEDIUM_X2-	23	Input	Neg. Medium Data 2
MEDIUM_X2+	10	Input	Pos. Medium Data 2
MEDIUM_X3-	21	Input	Neg. Medium Data 3
MEDIUM_X3+	8	Input	Pos. Medium Data 3
MEDIUM_XCLK-	22	Input	Neg. Medium Clock
MEDIUM_XCLK+	9	Input	Pos. Medium Clock
TERM	20		Term Resistor
TERM	7		Term Resistor
FULL_X0-	19	Input	Neg. Full Data 0
FULL_X0+	6	Input	Pos. Full Data 0
FULL_X1-	18	Input	Neg. Full Data 1
FULL_X1+	5	Input	Pos. Full Data 1
FULL_X2-	17	Input	Neg. Full Data 2
FULL_X2+	4	Input	Pos. Full Data 2
FULL_X3-	15	Input	Neg. Full Data 3
FULL_X3+	2	Input	Pos. Full Data 3
FULL_XCLK-	16	Input	Neg. Full Clock
FULL_XCLK+	3	Input	Pos. Full Clock
GND	1, 13, 14, 26		Ground

Camera Link Camera Control Signal Overview

Four LVDS pairs are for general-purpose camera control, defined as camera inputs / frame grabber outputs by the Camera Link Base camera specification. These controls are on J2 and also on J3 for the second Base camera input of the X64 Xcelera-CL PX4 in two Base configuration.

- Camera Control 1 (CC1)
- Camera Control 2 (CC2)
- Camera Control 3 (CC3)
- Camera Control 4 (CC4)

Each camera manufacture is free to define the signals input on any one or all four control signals. These control signals are used either as camera control pulses or as a static logic state. Control signals not required by the camera are simply assigned as not used. Refer to your camera's user manual for information on what control signals are required.



Note 1: The X64 Xcelera-CL PX4 pulse controller has a minimum resolution of 100ns us for line trigger signals, and resolution of 1 μ s for all other signal. When configuring the Camera Link control signals, such as exposure control, etc. use values in increments of 1 us.

Note 2: The internal line trigger frequency has a 1 μ s resolution.

The X64 Xcelera-CL PX4 can assign any camera control signal to the appropriate Camera Link control. The following screen shot shows the Sapera CamExpert dialog where Camera Link controls are assigned.

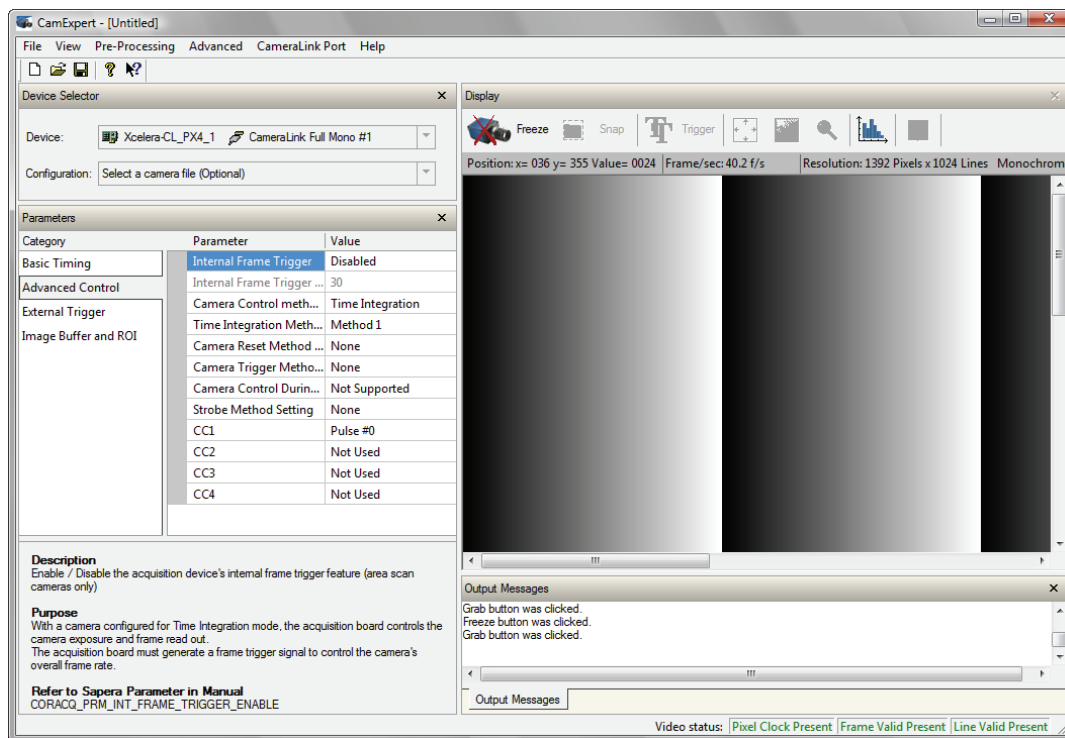

J4: External Signals Connector

J4 Pin Header Numbering Detail

2	4	...	38	40
1	3	...	37	39

J4 Signal Descriptions

Description	Pin #	Pin #	Description
Ground	1	2	Ground
General Input 1 + (see note 1)	3	4	General Input 1 -
General Input 2 +	5	6	General Input 2 -
General Input 3 +	7	8	General Input 3 -
General Input 4 +	9	10	General Input 4 -
General Output 1 + (see note 2)	11	12	General Output 1 -
General Output 2 +	13	14	General Output 2 -
General Output 3 +	15	16	General Output 3 -
General Output 4 +	17	18	General Output 4 -
External Trigger Input 1 + (see note 3)	19	20	External Trigger Input 1 -
External Trigger Input 2 +	21	22	External Trigger Input 2 -
Shaft Encoder Phase A + (see note 4)	23	24	Shaft Encoder Phase A -
Shaft Encoder Phase B +	25	26	Shaft Encoder Phase B -
Ground	27	28	Strobe Output 1 (see note 5)
Ground	29	30	Strobe Output 2
Ground	31	32	Ground
Power Output 5 Volts, 1.5A max (see note 6)	33	34	Power Output 5 Volts, 1.5A max
Power Output 12 Volts, 1.5A max	35	36	Power Output 12 Volts, 1.5A max
Ground	37	38	Ground
Ground	39	40	Ground

Note 1: General Inputs Specifications

Each of the four General Inputs are opto-coupled and able to connect to differential signals (RS-422) or single ended source signals. These inputs generate individual interrupts and are read by the Sopera application. The following figure is typical for each General Input.

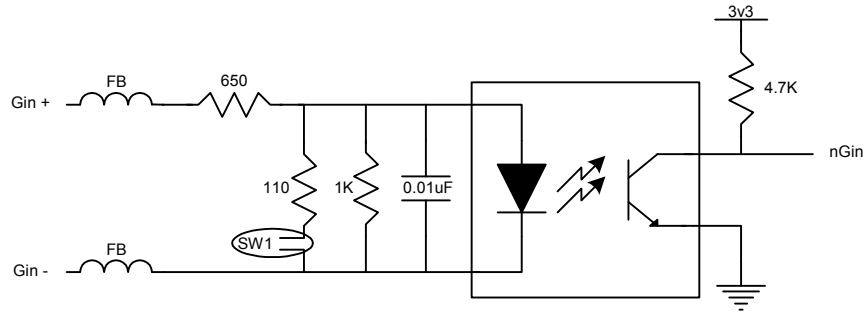

Input Details:

- For single ended signals, the Gin- pin is connected to ground. The switch point is $\sim 10\text{V}$ by default and can be changed to $\sim 2\text{V}$ with **SW1**.
- Each input has a ferrite bead plus a 650 ohm series resistor on the opto-coupler anode.
- The 1K resistor and 0.01uF capacitor provide high frequency noise filtering.
- Maximum input voltage that can be applied is 26V.
- Maximum input signal frequency is 25 KHz.
- Opto-coupler response time is $10\mu\text{s}$ for the rising edge signal.
- Opto-coupler response time is $27\mu\text{s}$ for the falling edge signal.

Note 2: General Outputs Specifications

Each of the four General Outputs are opto-coupled. Each output is an isolated open-collector NPN transistor switch. The following figure is typical for each General Output.

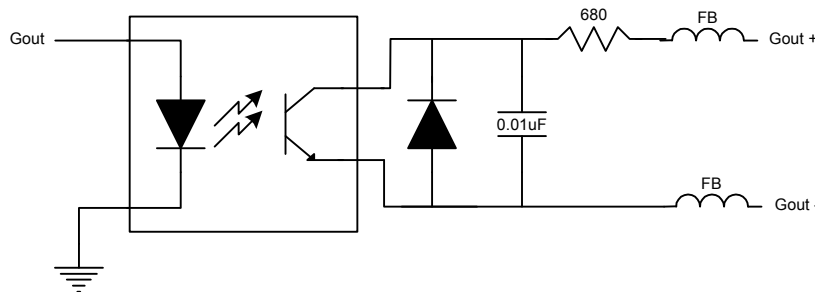

Output Details:

- Each output has ferrite beads plus a 680 ohm series resistor on the cathode (+) connection.
- The diode and capacitor provide reverse voltage protection and noise filter
- Maximum output device differential voltage is 25V.
- Maximum output device sink current is 35mA with 25V output differential.
- Maximum reverse voltage is 25V.
- Maximum output switching frequency is limited by driver and register access on the PCIe bus.

Note 3: External Trigger Input Specifications

The two Trigger Inputs are opto-coupled and compatible to differential signals (RS422) or single ended source signals. The following figure is typical for each External Trigger Input.

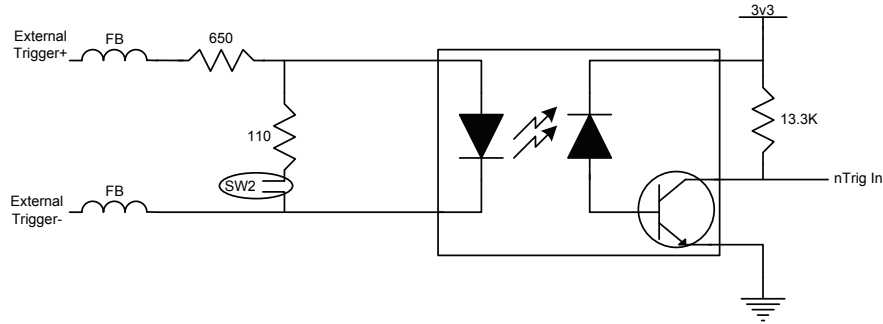

- For single ended signals, the External Trigger - pin is connected to ground. The switch point is $\sim 2V$ by default to support TTL 5V signals and can be changed to $\sim 10V$ with **SW2** to support 24V industry standard signals.
- For RS422 differential signals, switch point must be selected to $\sim 2V$.
- Maximum external signal input voltage is 26V, irrelevant of the selected switch point.
- The incoming trigger pulse is "debounced" to ensure that no voltage glitch is detected as a valid trigger pulse. This debounce circuit time constant can be programmed from $1\mu s$ to $255\mu s$. Any pulse smaller than the programmed value is blocked and therefore not seen by the acquisition circuitry. If no debouncing value is specified (value of $0\mu s$), the minimum value of $1\mu s$ will be used.
- Each input has a ferrite bead plus a 650 ohm series resistor on the opto-coupler anode.
- Maximum input signal frequency is 100 KHz.
- Opto-coupler response time is $1.95\mu s$ for a rising signal.
- Opto-coupler response time is $2.9\mu s$ for a falling signal.
- Refer to Sapers parameters:
CORACQ_PRM_EXT_TRIGGER_SOURCE
CORACQ_PRM_EXT_TRIGGER_ENABLE
CORACQ_PRM_EXT_TRIGGER_LEVEL
CORACQ_PRM_EXT_FRAME_TRIGGER_LEVEL
CORACQ_PRM_EXT_TRIGGER_DETECTION
CORACQ_PRM_EXT_TRIGGER_DURATION
- See also *.cvi file entries:
External Trigger Level, External Frame Trigger Level, External Trigger Enable, External Trigger Detection.
- External Trigger Input 2 used for two pulse external trigger with variable frame length linescan acquisition.

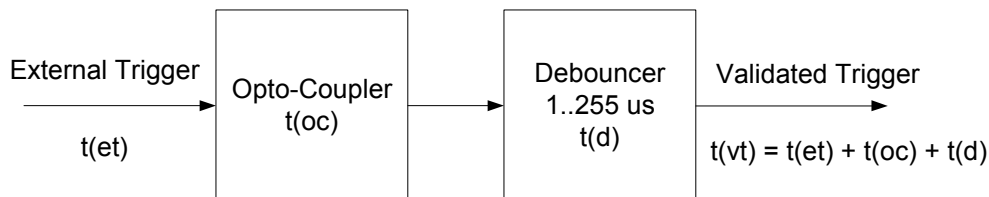

Figure 4: External Trigger Input Validation & Delay

Let	$t(et)$ = time of external trigger in μs $t(vt)$ = time of validated trigger in μs $t(oc)$ = time opto-coupler takes to change state $t(d)$ = debouncing duration from 1 to $255\mu s$
<i>trigger high</i>	For an active high external trigger, $t(oc) = 1.95\mu s$: $t(vt) = t(et) + 1.95\mu s + t(d)$
<i>trigger low</i>	For an active low external trigger, $t(oc) = 2.9\mu s$: $t(vt) = t(et) + 2.9\mu s + t(d)$



Note: DALSA recommends using an active high external trigger to minimize the time it takes for the opto-coupler to change state. Specifically, the opto-coupler response time is $1.95\mu s$ for active high compared to $2.9\mu s$ for active low.

If the duration of the external trigger is $> t(oc) + t(d)$, then a valid acquisition trigger is detected. Therefore, the external pulse with active high polarity must be at least $2.95\mu s$ (if debounce time is set to 1) in order to be acknowledged. Any pulse larger than $3.9\mu s$ is always considered valid.

It is possible to emulate an external trigger using the software trigger which is generated by a function call from an application.

Note 4: Shaft Encoder Input Specifications

Dual Quadrature Shaft Encoder Inputs (phase A and phase B) are opto-coupled and able to connect to differential signals (RS-422) or single ended TTL 5V source signals. The following figure is typical for each input.

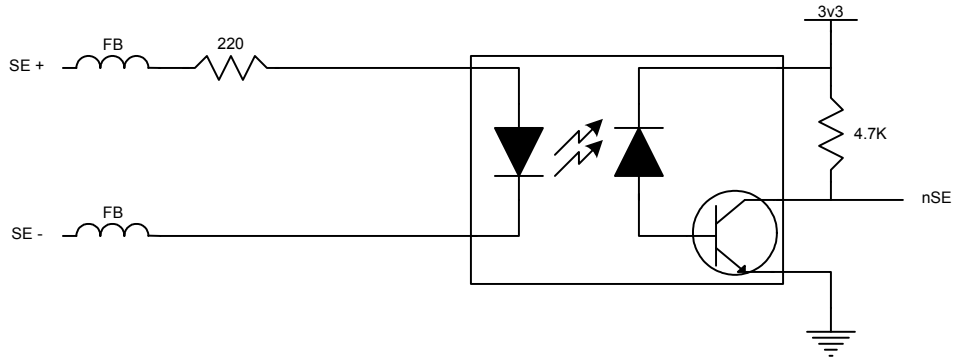

- For single ended TTL 5V signals, the switch point is $\sim 2V$.
- Maximum input differential voltage that can be applied is 6V.
- The incoming trigger pulses are "debounced" to ensure that no voltage glitch is detected as a valid trigger pulse. The debouncer circuit is set to 100nsec.
- Each input has a ferrite bead plus a 220 ohm series resistor on the opto-coupler anode.
- Maximum input signal frequency is 200 KHz.
- Opto-coupler response time is $0.8\mu s$ for a rising signal.
- Opto-coupler response time is $1.7\mu s$ for a falling signal.
- When using a single ended TTL signal, the minimum current to drive or sink is calculated with the following formula:
 - current required = $(TTV \text{ Voltage Level} - 1.5V) / 220$
 For example, for a 5V TTL signal the minimum current is 16mA
- For a typical single ended TTL signal connection:
 - Connect SE+ to TTL output signal

- Connect SE- to TTL signal ground
- The TTL output signal must be able to drive enough current based on the formula given above
- Alternate single ended TTL signal connection:
 - Connect SE+ to VCC
 - Connect SE- to TTL output signal
 - The TTL output signal must be able to sink enough current based on the formula given above
- See "Line Trigger Source Selection for Linescan Applications" on page 39 for more information.
- Refer to Sopera parameters:
CORACQ_PRM_SHAFT_ENCODER_ENABLE CORACQ_PRM_SHAFT_ENCODER_DROP
CORACQ_PRM_SHAFT_ENCODER_MULTIPLY
or refer to CORACQ_PRM_EXT_LINE_TRIGGER_ENABLE
CORACQ_PRM_EXT_LINE_TRIGGER_DETECTION
CORACQ_PRM_EXT_LINE_TRIGGER_LEVEL (fixed at RS-422)
CORACQ_PRM_EXT_LINE_TRIGGER_SOURCE
- See also *.cvi file entries:
Shaft Encoder Enable, Shaft Encoder Pulse Drop
or see External Line Trigger Enable, External Line Trigger Detection, External Line Trigger Level,
External Line Trigger Source.

Note 5: Strobe Output Specifications

Dual TTL Strobe outputs are provided. The following figure is typical for each strobe out.

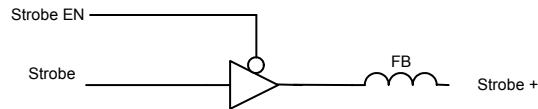

- Each strobe output is a tri-state driver, enabled by software.
- Each strobe output is 5V TTL level.
- Each output has a ferrite bead.
- Maximum source current is 32mA typical.
- Maximum sink current is 32mA typical.
- Output switching is < 4.2ns typical.
- Refer to Sopera Strobe Methods parameters:
CORACQ_PRM_STROBE_ENABLE
CORACQ_PRM_STROBE_POLARITY
CORACQ_PRM_STROBE_LEVEL
CORACQ_PRM_STROBE_METHOD
CORACQ_PRM_STROBE_DELAY
CORACQ_PRM_STROBE_DURATION
- See also *.cvi file entries:
Strobe Enable, Strobe Polarity, Strobe Level, Strobe Method, Strobe Delay, Strobe Duration.

Note 6: DC Power Details & J7



Warning: Never remove or install any hardware component with the computer power on. Never connect a floppy drive power cable to J7 when the computer is powered on.

- Connect the PC floppy drive power connector to J7 so as to supply DC power to a camera. Both 5Vdc and 12Vdc are available on J4 or on the DB37 External Signals Bracket Assembly.
- DC power connected to J7 also applies when using PoCL cameras.
- Both the 5Volt and 12Volt power pins have a 1.5 amp re-settable fuse on the board. If the fuse is tripped, turn off the host computer power. When the computer is turned on again, the fuse is automatically reset.

External Signals Connector Bracket Assembly (Type 1)

The External Signals bracket (OC-X4CC-IOCAB) provides a simple way to bring out the signals from the External Signals Connector J4 to a bracket mounted DB37. Install the bracket assembly into an adjacent PC expansion slot and connect the free cable end to the board's J4 header. When connecting to J4, make sure that the cable pin 1 goes to J4 pin 1 (see the layout drawing "X64 Xcelera-CL PX4 Board Layout Drawing" on page 62).



Note: For additional independent I/O signals use the optional X-I/O module. See "Appendix: X-I/O Module Option" on page 80.

External Signals Connector Bracket Assembly (Type 1) Drawing

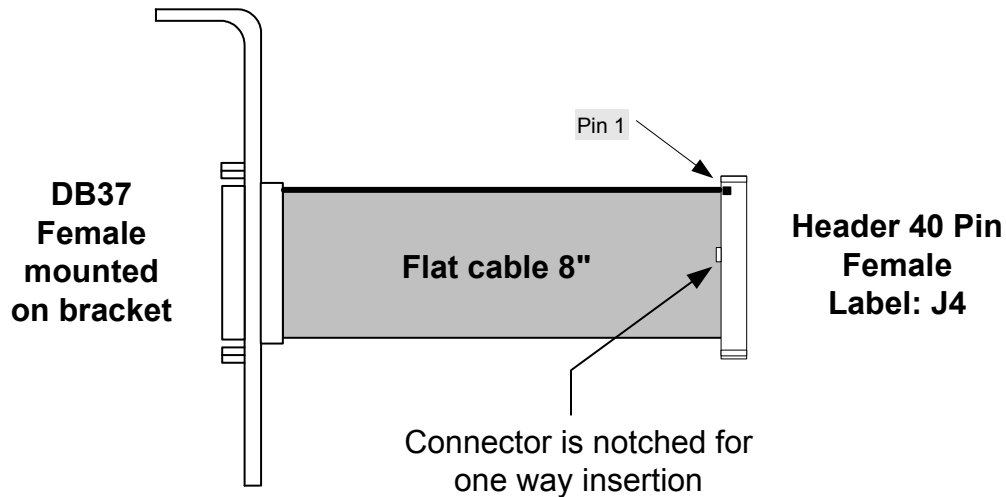

External Signals Connector Bracket Assembly (Type 1) Pinout

The following table defines the signal pinout on the DB37 connector. Refer to the table "J4: External Signals Connector " on page 69 for signal descriptions.

DB37 Pin Number	Signal	J4 Connector Pin Number
1	Ground	1
20	Ground	2
2	General Input 1 +	3
21	General Input 1 -	4
3	General Input 2 +	5
22	General Input 2 -	6
4	General Input 3 +	7
23	General Input 3 -	8
5	General Input 4 +	9
24	General Input 4 -	10
6	General Output 1 +	11
25	General Output 1 -	12
7	General Output 2 +	13
26	General Output 2 -	14
8	General Output 3 +	15
27	General Output 3 -	16
9	General Output 4 +	17
28	General Output 4 -	18
10	External Trigger Input 1 +	19
29	External Trigger Input 1 -	20
11	External Trigger Input 2 +	21
30	External Trigger Input 2 -	22
12	Shaft Encoder Phase A +	23
31	Shaft Encoder Phase A -	24
13	Shaft Encoder Phase B +	25
32	Shaft Encoder Phase B -	26
14	Ground	27
33	Strobe Output 1	28
15	Ground	29
34	Strobe Output 2	30
16	Ground	31
35	Ground	32
17	+5V	33
36	+5V	34
18	+12V	35
37	+12V	36
19	Ground	37
—	—	38
—	—	39
—	—	40

External Signals Connector Bracket Assembly (Type 2)

The External Signals bracket (OR-X4CC-0TIO2) provides a simple way to bring out the signals from the External Signals Connector J4 to a bracket mounted DB25. External cables designed for the Teledyne DALSA X64-CL iPro can be connected directly.

Install the bracket assembly into an adjacent PC expansion slot and connect the free cable end to the board's J4 header. When connecting to J4, make sure that the cable pin 1 goes to J4 pin 1 (see the layout drawing "X64 Xcelera-CL PX4 Board Layout Drawing" on page 62).



Note: For additional independent I/O signals use the optional X-I/O module. See "Appendix: X-I/O Module Option" on page 80.

External Signals Connector Bracket Assembly (Type 2) Drawing

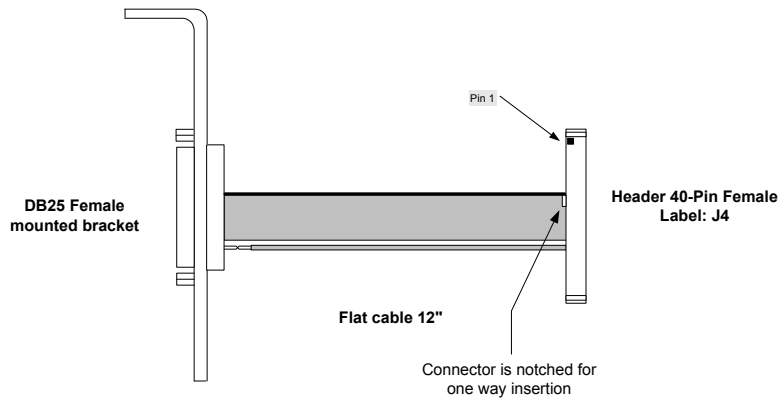

External Signals Connector Bracket Assembly (Type 2) Pinout

The following table defines the signal pinout on the DB25 connector. Refer to the table "J4: External Signals Connector" on page 69 for signal descriptions.

DB25 Pin Number	Signal	J4 Connector Pin Number
6	External Trigger Input 1 +	19
19	External Trigger Input 1 -	20
7	External Trigger Input 2 +	21
20	External Trigger Input 2 -	22
8	Shaft Encoder Phase A +	23
21	Shaft Encoder Phase A -	24
9	Shaft Encoder Phase B +	25
22	Shaft Encoder Phase B -	26
11	Strobe Output 1	28
24	Ground	29
10	Strobe Output 2	30
14	Ground	31
15	Ground	38
16	Ground	39
25	Ground	40

J9: Board Sync

Interconnects multiple X64 Xcelera boards to synchronize acquisitions to one trigger or event. The trigger source can be either an external signal or internal software trigger. The board receiving the trigger is the Master board, while the boards receiving the control signal from the Master board are Slaves.

Setup of the master and slave boards is either by setting parameters via a Sopera application or by using CamExpert to configure two camera files (.ccf). For testing purposes, two instances of CamExpert can be run on the system with the frame grabbers installed.

- **Hardware Connection:** Interconnect two, three, or four X64 Xcelera boards via their J9 connector. The 4 pin cable is wired one to one — i.e. no crossed wires. The cable must be as short as possible and the boards must be in the same system.
- **Master Board Software Setup:** Choose one X64 Xcelera as master. The Sopera parameter CORACQ_PRM_EXT_TRIGGER_SOURCE is set to either *Mode 1-Output to Board Sync* or *Mode 2-Control pulse to Board Sync*. Other parameters are set as for any external trigger application, such as External Trigger enable, detection, and level. See Sopera documentation for more details.
 - **Mode 1 – Output to Board Sync:**
In this mode, the external trigger signal received by the board is sent to Board Sync without any qualification by the Master. The signal output on Board Sync will have a fixed polarity and duration. The time between the reception of the external trigger signal on the Master (after the opto-coupler) and the signal sent to Board Sync will be less than 25 nsec.
 - **Mode 2 – Control pulse to Board Sync:**
In this mode, the external trigger signal received is first processed by the Master. If the decision is made to use the trigger (ie. not ignored), the CC1 signal output by the Master will also be replicated to the Board Sync with the same polarity and duration. The time between the reception of the external trigger signal on the Master (after the opto-coupler) and the decision to use or ignore the external trigger signal is < 1usec. The time between the CC1 output and the Board Sync signal is < 25 nsec.
- **Slave Board Software Setup:** The Sopera parameter CORACQ_PRM_EXT_TRIGGER_SOURCE is set to *From Board Sync*. Other parameters are ignored, such as External Trigger detection and level.
- **Test Setup:** The control application starts the acquisition on all slave boards. The acquisition process is now waiting for the control signal from the master board. The master board acquisition is triggered and the acquisition start signal is sent to each slave board (with ~0.8µs delay max).

Contact Technical Support for additional information.

Camera Link Interface

Camera Link Overview

Camera Link is a communication interface for vision applications developed as an extension of National Semiconductor's Channel Link technology. The advantages of the Camera Link interface are that it provides a standard digital camera connection specification, a standard data communication protocol, and simpler cabling between camera and frame grabber.

The Camera Link interface simplifies the usage of increasingly diverse cameras and high signal speeds without complex custom cabling. For additional information concerning Camera Link, see http://en.wikipedia.org/wiki/Camera_Link.

Rights and Trademarks

Note: The following text is extracted from the Camera Link Specification 1.1 (January 2004).

The Automated Imaging Association (AIA), as sponsor of the Camera Link committee, owns the U.S. trademark registration for the Camera Link logo as a certification mark for the mutual benefit of the industry. The AIA will issue a license to any company, member or non-member, to use the Camera Link logo with any products that the company will self-certify to be compliant with the Camera Link standard. Licensed users of the Camera Link logo will not be required to credit the AIA with ownership of the registered mark.

3M™ is a trademark of the 3M Company.

Channel Link™ is a trademark of National Semiconductor.

Flatlink™ is a trademark of Texas Instruments.

Panel Link™ is a trademark of Silicon Image.

Data Port Summary

The Camera Link interface has three configurations. A single Camera Link connection is limited to 28 bits requiring some cameras to have multiple connections or channels. The naming conventions for the three configurations are:

- Base: Single Channel Link interface, single cable connector.
- Medium: Two Channel Link interface, two cable connectors.
- Full: Three Channel Link interface, two cable connectors.

A single Camera Link port is defined as having an 8-bit data word. The "Full" specification supports 8 ports labeled as A to H.

Camera Signal Summary

Video Data

Four enable signals are defined as:

- FVAL Frame Valid (FVAL) is defined HIGH for valid lines.
- LVAL Line Valid (LVAL) is defined HIGH for valid pixels.
- DVAL Data Valid (DVAL) is defined HIGH when data is valid.
- Spare A spare has been defined for future use.

All four enables must be provided by the camera on each Channel Link. All unused data bits must be tied to a known value by the camera.

Camera Controls

Four LVDS pairs are reserved for general-purpose camera control, defined as camera inputs and frame grabber outputs.

- Camera Control 1 (CC1)
- Camera Control 2 (CC2)
- Camera Control 3 (CC3)
- Camera Control 4 (CC4)

	Note: the X64 Xcelera-CL PX4 by default implements the control lines as follows (using Teledyne DALSA Corporation terminology). (CC1) EXYNC (CC2) PRIN (CC3) FORWARD (CC4) HIGH
---	--

Communication

Two LVDS pairs have been allocated for asynchronous serial communication to and from the camera and frame grabber. Cameras and frame grabbers should support at least 9600 baud.

- SerTFG Differential pair with serial communications to the frame grabber.
- SerTC Differential pair with serial communications to the camera.

The serial interface protocol is one start bit, one stop bit, no parity, and no handshaking.

Camera Link Cables

For additional information on Camera Link cables and their specifications, visit the following web sites:

3 M	http://www.3m.com/interconnects/ <i>(enter Camera Link as the search keyword)</i>
Nortech Systems	http://www.nortechsys.com/intercon/CameraLinkMain.htm

Appendix: X-I/O Module Option

X-I/O Module Overview

- The X-I/O module requires X64 Xcelera-CL PX4 board driver version 1.00 (or later) and Sopera LT version 5.30 (or later).
- Occupies an adjacent slot to the X64 Xcelera-CL PX4. Slot can be either PCI-32 or PCI-64—no PCI signals or power are used.
- Connects to the X64 Xcelera-CL PX4 via a 16 pin flat ribbon cable. J23 on X-I/O to J6 on X64 Xcelera-CL PX4.
- The X-I/O signals supplement the external signal I/O available on the main board. The two sets of I/O are independent of each other.
- X-I/O provides 8 outputs software selectable as NPN (current sink) or PNP (source driver) type drivers. See "Outputs in NPN Mode: Electrical Details" on page 82 and "Outputs in PNP Mode: Electrical Details" on page 83.
- X-I/O provides 2 opto-coupled inputs. See "Opto-coupled Input: Electrical Details" on page 84.
- X-I/O provides 6 TTL level inputs with software selectable transition point. See "TTL Input Electrical Details" on page 84.
- X-I/O provides both +5 volt and +12 volt power output pins on the DB37, where power comes directly from the host system power supply (J26).
- Onboard flash memory to store user defined power up I/O states.

X-I/O Module Connector List & Locations

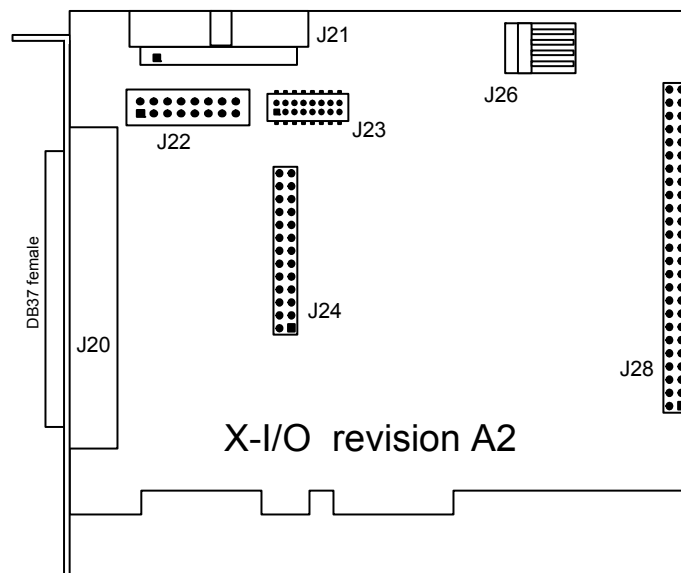

J20	DB37 female external signals connector.
J23	16 pin header connector (interconnect to the X64 Xcelera-CL PX4 via the supplied ribbon cable OC-IO0C-ANLVDS).
J21, J22, J24, J28	Reserved.
J26	Connect PC power via floppy drive power cable.

X-I/O Module Installation

Grounding Instructions: Static electricity can damage electronic components. Please discharge any static electrical charge by touching a grounded surface, such as the metal computer chassis, before performing any hardware installation. If you do not feel comfortable performing the installation, please consult a qualified computer technician. **Never** remove or install any hardware component with the computer power on.

Board Installation

Installing an X-I/O Module to an existing X64 Xcelera-CL PX4 installation takes only a few minutes. Install the X-I/O board into the host system as follows:

- Power off the computer system that has the installed X64 Xcelera-CL PX4 board.
- Insert the X-I/O module into any free PCI slot (no PCI electrical connections are used), securing the bracket.
- Connect a floppy drive power cable to J26 to provide power to the board and the external connector.
- Connect the X-I/O module 16 pin ribbon cable labeled OC-IO0C-ANLVDS from J23 to the X64 Xcelera-CL PX4 board J6.
- Power on the computer again.
- For new X64 Xcelera-CL PX4 and X-I/O module installations, simply follow the procedure to install Sopera and the X64 Xcelera-CL PX4 driver.

X64 Xcelera-CL PX4 and X-I/O Driver Update

- If both Sopera and X64 Xcelera-CL PX4 driver need to be installed, follow the procedure "Sopera and Board Driver Upgrades" on page 15. This procedure steps through the upgrade of both Sopera and the board driver—typically required when installing the X-I/O module in the field.
- If the X64 Xcelera-CL PX4 installation already has the required Sopera and board driver version, install the X-I/O module and perform a firmware update as described in "Executing the Firmware Loader from the Start Menu" on page 11.

X-I/O Module External Connections to the DB37

Users can assemble their interface cable, using some or all of the signals available on the X-I/O module DB37. Use a male DB37 with thumb screws for a secure fit. Wiring type should meet the needs of the imaging environment.

For the external signals Trigger Input, Shaft Encoder Input, and Strobe output (note: cannot be used with X64 Xcelera-CL PX8).

DB37 Pinout Description

Pin #	Signal	Description
1	IN_OPTO_1+	Input #1 (Opto-coupled)
20	IN_OPTO_1-	
2	IN_OPTO_2+	Input #2 (Opto-coupled)
21	IN_OPTO_2-	
3, 23, 24	Gnd	
22	OUT_TTL_1	Output #1
4	OUT_TTL_2	Output #2
5	USER_PWR	Power for the TTL Outputs in PNP mode
6 *	TrigIn 1+	Trigger Input 1 +
25 *	TrigIn 1-	Trigger Input 1 - (TTL trigger GND)
7 *	TrigIn 2+	Trigger Input 2 +
26 *	TrigIn 2-	Trigger Input 2 - (TTL trigger GND)
8 *	Phase A+	Shaft Encoder Phase A+
27 *	Phase A-	Shaft Encoder Phase A-
9 *	Phase B+	Shaft Encoder Phase B+
28 *	Phase B-	Shaft Encoder Phase B-
10 *	Strobe 2	TTL Strobe 2 output
11 *	Strobe 1	TTL Strobe 1 output
16, 29, 30	Gnd	
12	Power	PC +5V (1A max)
31	Power	PC +12V (1A max)
13	IN_TTL_3	Input #3 (TTL)
32	IN_TTL_4	Input #4 (TTL)
14	IN_TTL_5	Input #5 (TTL)
33	IN_TTL_6	Input #6 (TTL)
15	IN_TTL_7	Input #7 (TTL)
34	IN_TTL_8	Input #8 (TTL)
35	OUT_TTL_3	Output 3
17	OUT_TTL_4	Output 4
36	OUT_TTL_5	Output 5
18	OUT_TTL_6	Output 6
37	OUT_TTL_7	Output 7
19	OUT_TTL_8	Output 8

*: Note, these signals are not available with the X64 Xcelera-CL PX4.

Outputs in NPN Mode: Electrical Details

When the TTL outputs are configured for NPN mode (open collector - sink mode) the user is required to provide an external input pull-up resistor on the signal being controlled by the X-I/O output. A simplified schematic and important output specifications follow:

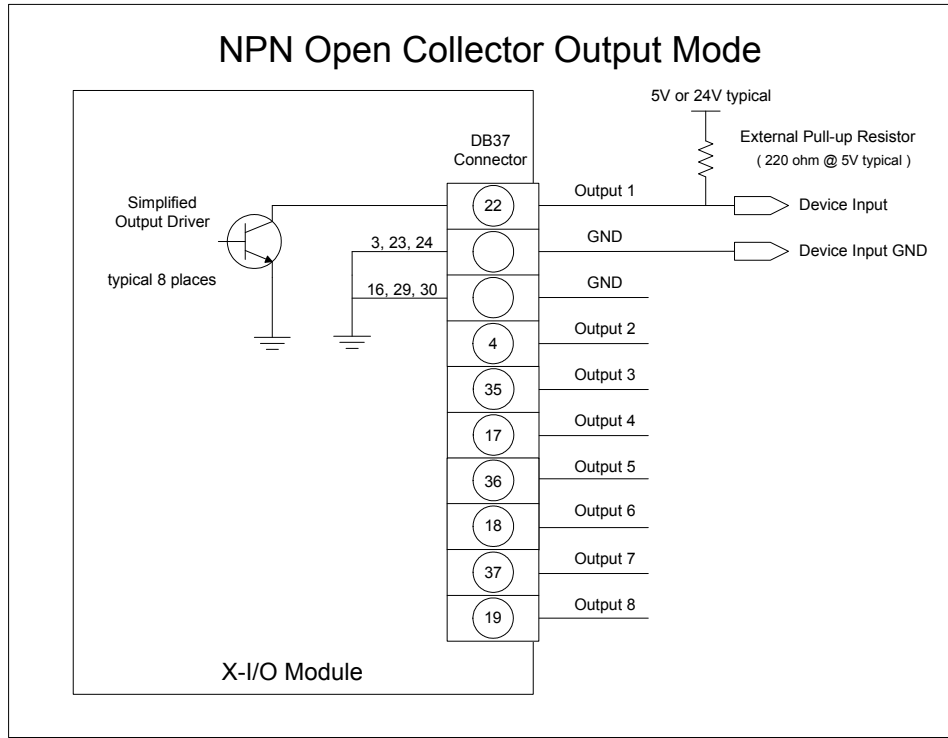

- Each output can sink 700 mA.
- Over-current thermal protection will automatically shut down the output device.

Outputs in PNP Mode: Electrical Details

When the TTL outputs are configured for PNP mode (source driver) an external power supply is required to provide the buffer output supply voltage (USER_PWR). A simplified schematic and important output specifications follow:

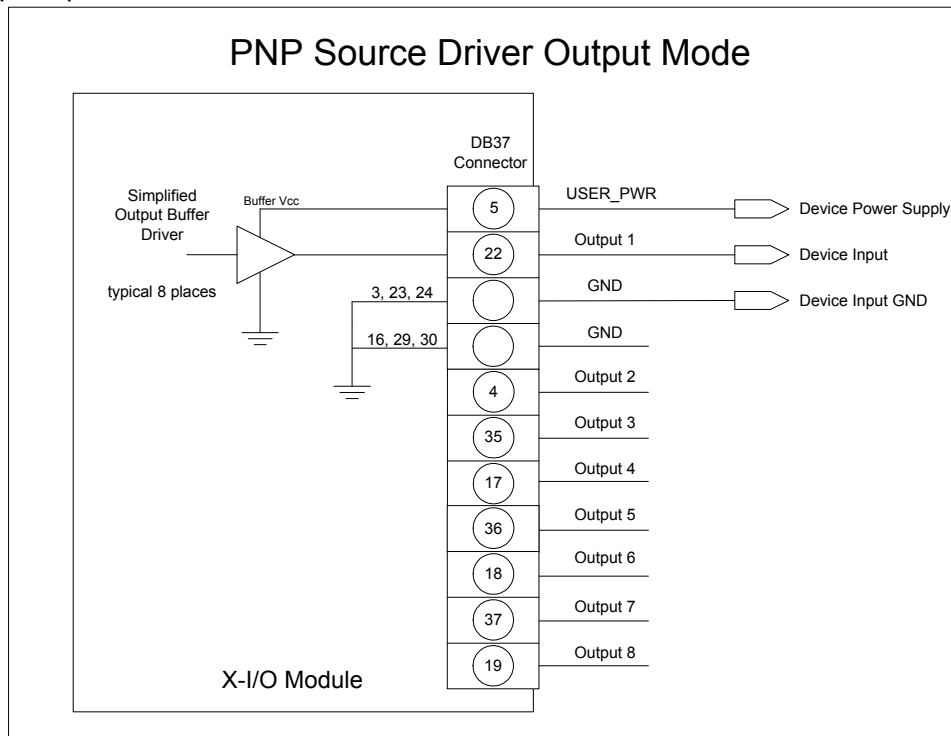

- User provides the output power supply voltage (7 volts to 35 volts).
- Maximum source driver output current is 350 mA.

- Source driver with over-current protection (all outputs will shut down simultaneously). The over-current fault circuit will protect the device from short-circuits to ground with supply voltages of up to 35V.

Opto-coupled Input: Electrical Details

The two opto-coupled inputs can be used either with TTL or RS422 sources. A simplified input schematic and important electrical specifications are listed below.

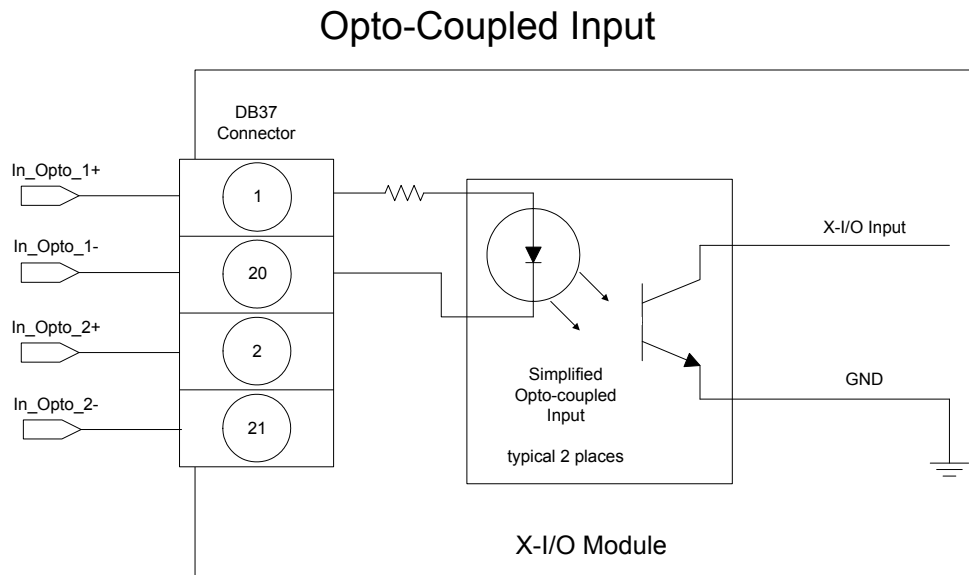

Input reverse breakdown voltage	5 volts minimum
Maximum average forward input current	25 mA
Maximum input frequency	200 kHz
Maximum Sapera call-back rate	System processing dependent

TTL Input Electrical Details

The six TTL inputs are software configurable (see "[Configuring User Defined Power-up I/O States](#)" on [page 85](#)) for standard TTL logic levels or industrial logic systems (typically 24 volts). The design switch points are as follows:

- TTL level mode : trip point at 2V +/- 5%
- Industrial level mode: trip point at 16V +/- 5%

X-I/O Module Sopera Interface

Sopera version 5.30 (or later) provides support for the X-I/O module via an I/O class and demonstration program. Users can use the demonstration program as is, or use the demo program source code to implement X-I/O controls within the custom imaging application.

This section describes configuring the X-I/O module power up state, using the X-I/O demo program, and describes the Sopera Class to program and read the X-I/O module along with sample code.

Configuring User Defined Power-up I/O States

The X-I/O module power up state is stored onboard in flash memory. User configuration of this initial state is performed by the Device Manager program. Run the program via the windows start menu: (**Start • Programs • Teledyne DALSA • X64 Xcelera-CL PX4 Device Driver • Device Manager**).

The Device Manager provides information on the installed X64 Xcelera-CL PX4 board and its firmware. With an X-I/O module installed, click on **XIO Board – Information**, as shown in the following figure.

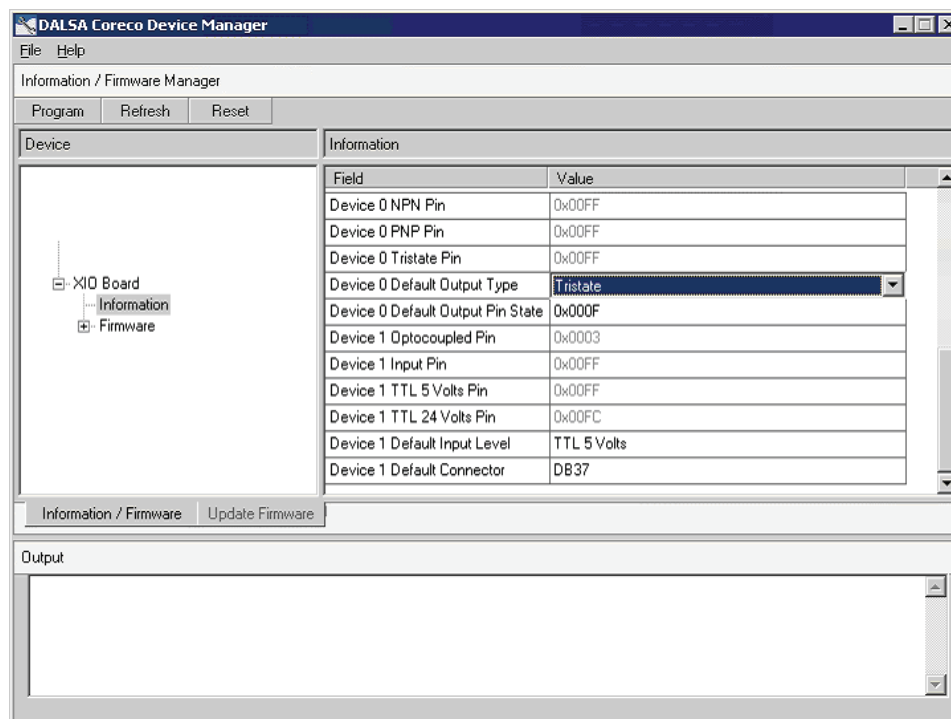

The XIO information screen shows the current status of **Device 0**—the output device, and **Device 1**—the input device. A few items are user configurable for X-I/O board power up state. Click on the item to display a drop list of available capabilities, as described below.

- **Device 0 – Default Output Type**
choose Tristate mode (i.e. output disconnected), or PNP mode, or NPN mode.
- **Device 0 – Default Output Pin State**
A window is displayed to select a logic low or high state for each output pin. Click on each pin that should be logic high by default.
- **Device 1 – Default Input Level**
Select the input logic level as TTL 5 Volts or 24 Volts, dependent on the signal type being input to the X-I/O module.
- **Device 1 – Default Connector**
DB37 is the supported output connector, as described in this section.

Programming the User Configuration

After changing any user configurable X-I/O mode from the factory default state, click on the **Program** button (located on the upper left), to write the new default state to flash memory. The Device Manager message output window will display "Successfully updated EEPROM". The program can now be closed.

Using Sapera LT General I/O Demo

The Sapera General I/O demo program controls the I/O capabilities of the X-I/O module on the Sapera board product. The demo will present to the user only the controls pertaining to the selected hardware (in the case of multiple installed boards).

Run the demo via the windows start menu: (**Start • Programs • Teledyne DALSA • Sapera LT • Demos • General I/O Demo**). The first menu presents a drop list of all installed Sapera Acquisition Devices with I/O capabilities. Select the X64 Xcelera-CL PX4 board is selected and click OK to continue.

General I/O Module Control Panel

The I/O module control demo presents the I/O capabilities of the installed hardware. The following figure shows the X-I/O module connected to the X64 Xcelera-CL PX4 board.

Output Pins: The first column displays the current state of the eight output pins (I/O Device #0).

- The startup default state is user configured using the Device Manager program.
- The state of each output can be changed by clicking on its status button.
- Use the Signal Output drop menu to select the output mode (Tristate, PNP, NPN).

Input Pins: The second section provides input pin status (I/O device #1). Note that this program is a demo, therefore no action takes place on an input event.

- The first column reads the logic level present on each input. The Input Level drop menu changes the logic level from 5V TTL to 24V logic. Use the Device Manager program to select the default logic level type.
- The second column demonstrates activating interrupts on individual inputs. In this demo program, use the Enable box to activate the interrupt on an input. The Count box will tally detected input events. Use the Signal Event drop menu to select which input signal edge to detect. The Reset button clears all event counts.

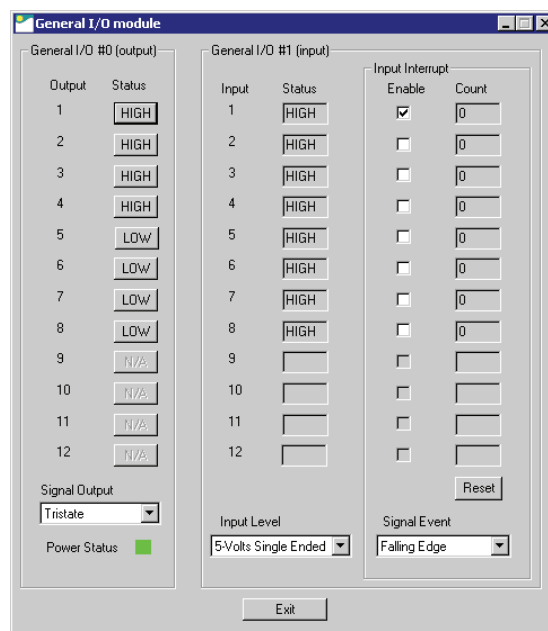

Sapera LT General I/O Demo Code Samples

The following source code was extracted from the General I/O demo program. The comments highlight the areas that an application developer needs for embedding X-I/O module controls within the imaging application.

Main I/O Demo code

```
BOOL CGioMainDlg::OnInitDialog()
{
    [ . . . ]

    // some declarations
    UINT32 m_gioCount;
    int m_ServerIndex;
    int m_ResourceIndex;

    // Show the Server Dialog to select the acquisition device
    CGioServer dlg(this);
    if (dlg.DoModal() == IDOK)
    {
        m_ServerIndex = dlg.GetServerIndex();
        m_ServerName = dlg.GetServerName();

        if ( m_ServerIndex != -1)
        {
            // Get the number of resources from SapManager for ResourceGio type by using
            // - the server index chosen in the dialog box
            // - the resource type to enquire for Gio
            m_gioCount=SapManager::GetResourceCount(m_ServerIndex,SapManager::ResourceGio);

            // Create all objects [see the function following]
            if (!CreateObjects()) { EndDialog(TRUE); return FALSE; }

            [ . . . ]

            //Loop for all resources
            for (UINT32 iDevice = 0; (iDevice < MAX_GIO_DEVICE) && (iDevice < m_gioCount);
                iDevice++)
            {
                [ . . . ]

                // direct read access to low-level Sapera C library capability to check
                // I/O Output module
                if (m_pGio[iDevice]->IsCapabilityValid(CORGIO_CAP_DIR_OUTPUT))
                    status = m_pGio[iDevice]->GetCapability(CORGIO_CAP_DIR_OUTPUT,&capOutput);

                // direct read access to low-level Sapera C library capability to
                // check I/O Input module
                if (m_pGio[iDevice]->IsCapabilityValid(CORGIO_CAP_DIR_INPUT))
                    status = m_pGio[iDevice]->GetCapability(CORGIO_CAP_DIR_INPUT,&capInput);

                [ . . . ]
                // Constructor used for I/O Output module dialog.
                if (capOutput)
                {
                    m_pDlgOutput[iDevice] = new CGioOutputDlg(this, iDevice, m_pGio[iDevice]);
                }

                [ . . . ]

                // Constructor used for I/O Input module dialog.
                if (capInput)
                {
                    m_pDlgInput[iDevice] = new CGioInputDlg(this, iDevice, m_pGio[iDevice]);
                }
            } //end for
        } // end if
    }
```

```
[ . . . ]  
}
```

Function CreateObjects()

```
BOOL CreateObjects()  
{  
    CWaitCursor wait;  
  
    // Loop for all I/O resources  
    for (UINT32 iDevice = 0; (iDevice < MAX_GIO_DEVICE) && (iDevice < m_gioCount);  
         iDevice++)  
    {  
        // The SapLocation object specifying the server where the I/O resource is located  
        SapLocation location(m_ServerIndex, iDevice);  
  
        // The SapGio constructor is called for each resource found.  
        m_pGio[iDevice] = new SapGio(location);  
  
        // Creates all the low-level Sopera resources needed by the I/O object  
        if (m_pGio[iDevice] && !*m_pGio[iDevice] && !m_pGio[iDevice]->Create())  
        {  
            DestroyObjects();  
            return FALSE;  
        }  
    }  
    return TRUE;  
}
```

Output Dialog: CGioOutputDlg class (see Sopera Gui class)

```
void CGioOutputDlg::UpdateIO()  
{  
    UINT32 output=0;  
    UINT32 state=0;  
    BOOL status;  
    [ . . . ]  
  
    // We loop to get all I/O pins.  
    for (UINT32 iIO=0; iIO < (UINT32)m_pGio->GetNumPins(); iIO++)  
    {  
        [ . . . ]  
  
        // We set the current state of the current I/O pin by using  
        // - the pin number on the current I/O resource  
        // - the pointer to pin state  
        // ( SapGio ::PinLow if low and SapGio ::PinHigh if high)  
        status = m_pGio->SetPinState(iIO, (SapGio::PinState)state);  
    }  
}
```

Input Dialog: CGioInputDlg class. (see Sapera Gui class)

```
BOOL CGioInputDlg::Update()
{
    SapGio::PinState state = SapGio::PinState::PinLow;
    BOOL status = true;
    UINT32 iIO;
    UINT32 jIO;

    if (m_pGio == NULL)
        return FALSE;

    // We loop to get all I/O pins.
    for (iIO=0; iIO < (UINT32)m_pGio->GetNumPins(); iIO++)
    {
        m_pGio->SetDisplayStatusMode(SapManager::StatusLog, NULL);
        // We get the current state of the current I/O pin by using
        // the pin number on the current I/O resource
        // the pointer to pin state
        // ( SapGio ::PinLow if low and SapGio ::PinHigh if high)

        status = m_pGio->GetPinState(iIO, &state);
        m_pGio->SetDisplayStatusMode(SapManager::StatusNotify, NULL);

        [ . . . ]
    }

    [ . . . ]
}
```

I/O Event Handling

```
void CGioInputDlg::GioCallbackInfo(SapGioCallbackInfo *pInfo)
{
    CGioInputDlg* pInputDlg;
    CString strEventCount;

    // We get the application context associated with I/O events
    pInputDlg = (CGioInputDlg*)pInfo->GetContext();

    // We get the current count of I/O events
    strEventCount.Format("%d", pInfo->GetEventCount());

    // We get the I/O pin number that generated an I/O event and apply the changes.
    pInputDlg->m_GioEventCount[pInfo->GetPinNumber()]++;
}
```



TELEDYNE DALSA
Everywhereyoulook™

Contact Information

Sales Information

Visit our web site: <http://www.teledynedalsa.com/imaging/>

Email: <mailto:info@teledynedalsa.com>

Canadian Sales

Teledyne DALSA — Head office
605 McMurray Road
Waterloo, Ontario, Canada, N2V 2E9
Tel: 519 886 6000
Fax: 519 886 8023

Teledyne DALSA — Montreal office
7075 Place Robert-Joncas, Suite #142
St. Laurent, Quebec, Canada, H4M 2Z2
Tel: (514) 333-1301
Fax: (514) 333-1388

USA Sales

Teledyne DALSA — Billerica office
700 Technology Park Drive
Billerica, Ma. 01821
Tel: (978) 670-2000
Fax: (978) 670-2010

European Sales

Teledyne DALSA GMBH
Felix-Wankel-Str. 1
82152 Krailling, Germany
Tel: +49 - 89 89 - 54 57 3-80
Fax: +49 - 89 89 - 54 57 3-46

Asian Sales

Teledyne DALSA Asia Pacific
Ikebukuro East 13F
3-4-3 Higashi Ikebukuro,
Toshima-ku, Tokyo, Japan
Tel: +81 3 5960 6353
Fax: +81 3 5960 6354

Shanghai Industrial Investment Building
Room G, 20F, 18 North Cao Xi Road,
Shanghai, China 200030
Tel: +86-21-64279081
Fax: +86-21-64699430

Technical Support

Any support question or request can be submitted via our web site:

Technical support form via our web page:
Support requests for imaging product
installations,
Support requests for imaging applications

<http://www.teledynedalsa.com/imaging/support/>

Camera support information

Product literature and driver updates

Glossary of Terms

Bandwidth

Describes the measure of data transfer capacity. PCI devices must share the maximum PCI bus bandwidth when transferring data to and from system memory or other devices.

CAM

Sapera camera file that uses the file extension CCA by default. Files using the CCA extension, also called CAM files (CAMERA files), contain all parameters which describe the camera video signal characteristics and operation modes (i.e. what the camera outputs).

Channel

Camera data path that includes all parts of a video line.

Checksum

A value used to ensure data is stored without error. It is created by calculating the binary values in a block of data using some algorithm and storing the results with the data.

CMI

Client **M**odification **I**nstruction. A client requested engineering change applied to a Teledyne DALSA board product to support either a non-standard function or custom camera.

Contiguous memory

A block of physical memory, occupying consecutive addresses.

CRC

Proprietary Sapera raw image data file format that supports any Sapera buffer type and utilizes an informative file header. Refer to the *Sapera Basic Modules Reference Manual* "Buffer File Formats" section.

Firmware

Software such as a board driver that is stored in nonvolatile memory mounted on that board.

Frame buffer

An area of memory used to hold a frame of image data. A frame buffer may exist on the acquisition hardware or be allocated by the acquisition hardware device driver in host system memory.

Grab

Acquiring an image frame by means of a frame grabber.

Host

Refers to the computer system that supports the installed frame grabber.

Host buffer

Refers to a frame buffer allocated in the physical memory of the host computer system.

LSB

Least Significant Bit in a binary data word.

MSB

Most Significant Bit in a binary data word.

PCI 32

Peripheral Component Interconnect. The PCI local bus is a 32-bit high-performance expansion bus intended for interconnecting add-in boards, controllers, and processor/memory systems.

PCI 64

A superset of the PCI specification providing a 64 bit data path and a 66 MHz clock.

Pixel

Picture Element. The number of pixels describes the number of digital samples taken of the analog video signal. The number of pixels per video line by the number of active video lines describes the acquisition image resolution. The binary size of each pixel (i.e., 8-bits, 15-bits, 24-bits) defines the number of gray levels or colors possible for each pixel.

RAW

A Sapera data file format where there is no header information and that supports any Sapera buffer type. Refer to the *Sapera Basic Modules Reference Manual* "Buffer File Formats" section.

RISC

(**R**educed **I**nstruction **S**et **C**omputer) A computer architecture that reduces chip complexity by using simpler instructions.

Scatter Gather

Host system memory allocated for frame buffers that is virtually contiguous but physically scattered throughout all available memory.

Tap

Data path from a camera that includes a part of or whole video line. When a camera tap outputs a partial video line, the multiple camera tap data must be constructed by combining the data in the correct order.

VIC

Sapera camera parameter definition file that uses the file extension CVI by default. Files using the CVI extension, also know as VIC files, contain all operating parameters related to the frame grabber board (i.e. what the frame grabber can actually do with camera controls or incoming video).

Index

I

10 tap format 49

A

Acquisition and Control Unit 45
acquisition bandwidth 27
Acquisition events 46
acquisition module 46
acquisition parameters 37
ACUPlus 7
administrator 15
AUTORUN 10

B

Bayer Filter Decoding 6, 7
Bayer Mosaic Filter 35
Block Diagram 39
BoardInfo.txt 17, 25
boot recovery mode 25
buffer output supply voltage 86

C

cables 66
calibration information 26
camera configuration file 29
camera control 16, 71
Camera file 32, 37, 43, 44
Camera Link 8, 66, 71, 81
Camera Link cabling 16
Camera Link control 71
camera power 66
camera timing 29
CamExpert 37, 43, 44
CamExpert parameters 29
communication ports 8
computer administrator 9
connector location 84
Contiguous Memory 18
CORACQ_PRM_EXT_LINE_TRIGGER_DETECTION 76
CORACQ_PRM_EXT_LINE_TRIGGER_ENABLE 76
CORACQ_PRM_EXT_LINE_TRIGGER_LEVEL 76
CORACQ_PRM_EXT_LINE_TRIGGER_SOURCE 76
CORACQ_PRM_EXT_TRIGGER_DETECTION 74
CORACQ_PRM_EXT_TRIGGER_ENABLE 74
CORACQ_PRM_EXT_TRIGGER_LEVEL 74
CORACQ_PRM_SHAFT_ENCODER_DROP 76
CORACQ_PRM_SHAFT_ENCODER_ENABLE 76
CORACQ_PRM_SHAFT_ENCODER_LEVEL 76
CORACQ_PRM_STROBE_DELAY 76
CORACQ_PRM_STROBE_DURATION 76
CORACQ_PRM_STROBE_ENABLE 76
CORACQ_PRM_STROBE_LEVEL 76
CORACQ_PRM_STROBE_METHOD 76
CORACQ_PRM_STROBE_POLARITY 76

D

Data Overflow event 46
Data Transfer Engine 7
Device Manager 10, 17, 25, 88
device report 17
double buffering memory 26
driver upgrade 15

E

Embedded Windows answer files 58
End of Frame event 47
End of Transfer event 47
External Signals Connector 41, 42, 44, 72, 78, 79
External Signals Connector Bracket Assembly 42, 77, 79

F

failure - firmware upgrade 24
Firmware Loader 10
firmware revision 17
firmware selection 6
Flat Field Correction 32
Found New Hardware Wizard 9
frame buffer 18, 44
Frame Lost event 46
Frame Sync 44
FRAME_RESET 44

H

HyperTerminal 8, 16

I

I/O available capabilities 88
I/O Device 0 88
I/O Device 1 88
I/O flash memory 88
I/O input event 89
I/O input trip points 87
I/O interface cable 84
I/O interrupts 89
I/O NPN output mode 88
I/O output modes 83
I/O PNP output mode 88
I/O power up state 88
I/O sample code 88
I/O source code 90
I/O Tristate output mode 88
image processing 5
Imaging drivers 24
Industrial level mode 87
input logic level 88
input pin status 89
input pull-up resistor 85
installer response file 12, 13

L

launch.exe 10
Line Scan 7, 42
Log Viewer program 26

LUT availability 48
LVDS pairs 71

M

MDR-26 66
Micro-switches 66
multi-board sync 80

N

National Semiconductor 81
NPN mode 85

O

opto-coupled input specs 87
out-of-memory error 18
output sink current 86
output source current 87

P

PCI bus latency 45
PCI Bus Number 23
PCI configuration registers 22
PCI configuration space 22, 25, 27
PCI conflict 25
Phase A 42
Phase B 42
physical dimensions 63
PNP mode 86
programming I/O flash 89

Q

Quadrature-Shaft-Encoder 8

S

Sapera Acquisition Devices 89
Sapera buffers allocation 18
Sapera CamExpert 27
Sapera CD-ROM 10, 15
Sapera configuration program 16, 17, 18
Sapera LT Development Library 9
Sapera LT User's manual 10
Sapera messaging 18
scatter gather buffers 19
Scatter-Gather 7
serial communication port 16
serial port speeds 16
Shading Correction 6, 7
shaft encoder 8, 42
software trigger 27, 75
Static electricity 9, 84
SW1-General Inputs signal level 67
SW2-Trigger signal level 67
SW3-GEN2 Slot Workaround 67
SW3-Safe Boot Mode 67
system COM port 16

T

technical support 15, 17, 24, 26

transfer module 47
trigger 8, 42, 44

U

user defined I/O state 83
USER_PWR 86

V

viewer program 26
virtual frame buffer 44
visual LED indicators 8

W

Web inspection 42
Windows Embedded 7 58
Windows HyperTerminal 16
Windows operating system memory 19
workstation 15

X

X64-CL serial port 16
X-I/O field installation 84
X-I/O module driver update 84
X-I/O module overview 83